

**NOTES:**

1. Material : Stainless Steel
2. Total Coils : 4.500
3. Solid Height : 0.450 (in)
4. Finish : ZINC
5. Ends : Closed
6. All Drawing Dimensions are in Inches [mm]

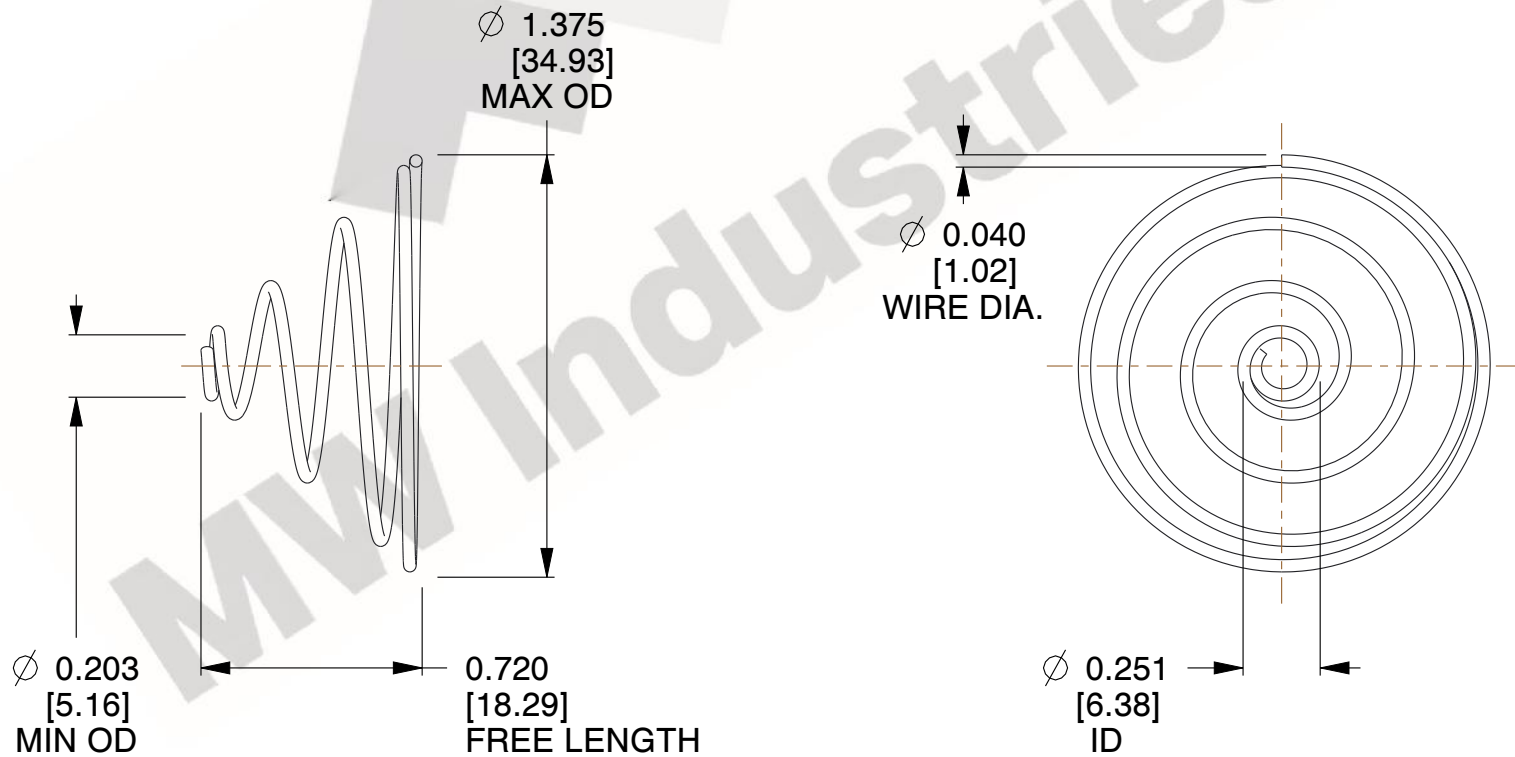
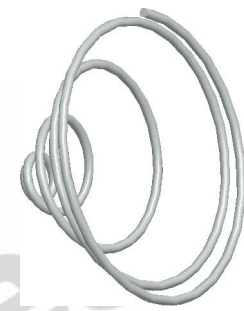

COMPONENT		TAPERED SPRINGS	
<b>TA-2204CS</b>		UNIT	
		INCH [mm]	
		SHEET	
TAPERED SPRINGS		1 of 1	