



The Future of Analog IC Technology®

## MP2637

### 2.5A Single Cell Switch Mode Battery Charger with Power Path Management (PPM) and 2.4A Boost Current with Trickle Timer

#### DESCRIPTION

The MP2637 is a highly-integrated, flexible, switch-mode battery charger with system power path management, designed for single-cell Li-ion or Li-Polymer batteries used in a wide range of applications.

The MP2637 can operate in both charge mode and boost mode to allow full system and battery power management.

When input power is present, the device operates in charge mode. It automatically detects the battery voltage and charges the battery in three phases: trickle current, constant current and constant voltage. Other features include charge termination and auto-recharge. This device also integrates both input current limit and input voltage regulation in order to manage input power and meet the priority of the system power demand.

In the absence of an input source, the MP2637 switches to boost mode through the MODE pin to power the SYS pins from the battery. The OLIM pin programs the output current limit in boost mode. The MP2637 also allows for output short circuit protection to completely disconnect the battery from the load in the event of a short circuit fault. Normal operation will recover as soon as the short circuit fault is removed. The MP2637 provides full operating status indication to distinguish charge mode from boost mode.

To guarantee safe operation, the MP2637 limits the die temperature to a preset value of 120°C. Other safety features include input over-voltage protection, battery over-voltage protection, thermal shutdown, battery temperature monitoring, and a programmable timer to prevent prolonged charging of a dead battery.

#### FEATURES

- Up to 16V Sustainable Input Voltage
- 4.5V-to-6V Operating Input Voltage Range
- Power Management function, Integrated Input-Current Limit, Input Voltage Regulation
- Up to 2.5A Programmable Charge Current
- Trickle-Charge Function
- Selectable 4.2V/ 4.35V Charge Voltage with 0.5% Accuracy
- Negative Temperature Coefficient Pin for Battery Temperature Monitoring
- Programmable Timer Back-Up Protection
- Thermal Regulation and Thermal Shutdown
- Internal Battery Reverse Leakage Blocking
- Integrated Over Voltage Protection and Over Current Protection for Pass-Through Path
- Reverse Boost Operation Mode for System Power
- Up to 2.4A Programmable Output Current Limit for Boost Mode
- Integrated Short Circuit Protection and Output Over Voltage Protection for Boost Mode
- Safety-Related Certification:
  - IEC 62368-1 AK Certification

#### APPLICATIONS

- Sub-Battery Applications
- Power-Bank Applications for Smart-Phone Tablet and Other Portable Devices

All MPS parts are lead-free, halogen free, and adhere to the RoHS directive. For MPS green status, please visit MPS website under Quality Assurance.

"MPS" and "The Future of Analog IC Technology" are Registered Trademarks of Monolithic Power Systems, Inc.

## TYPICAL APPLICATION

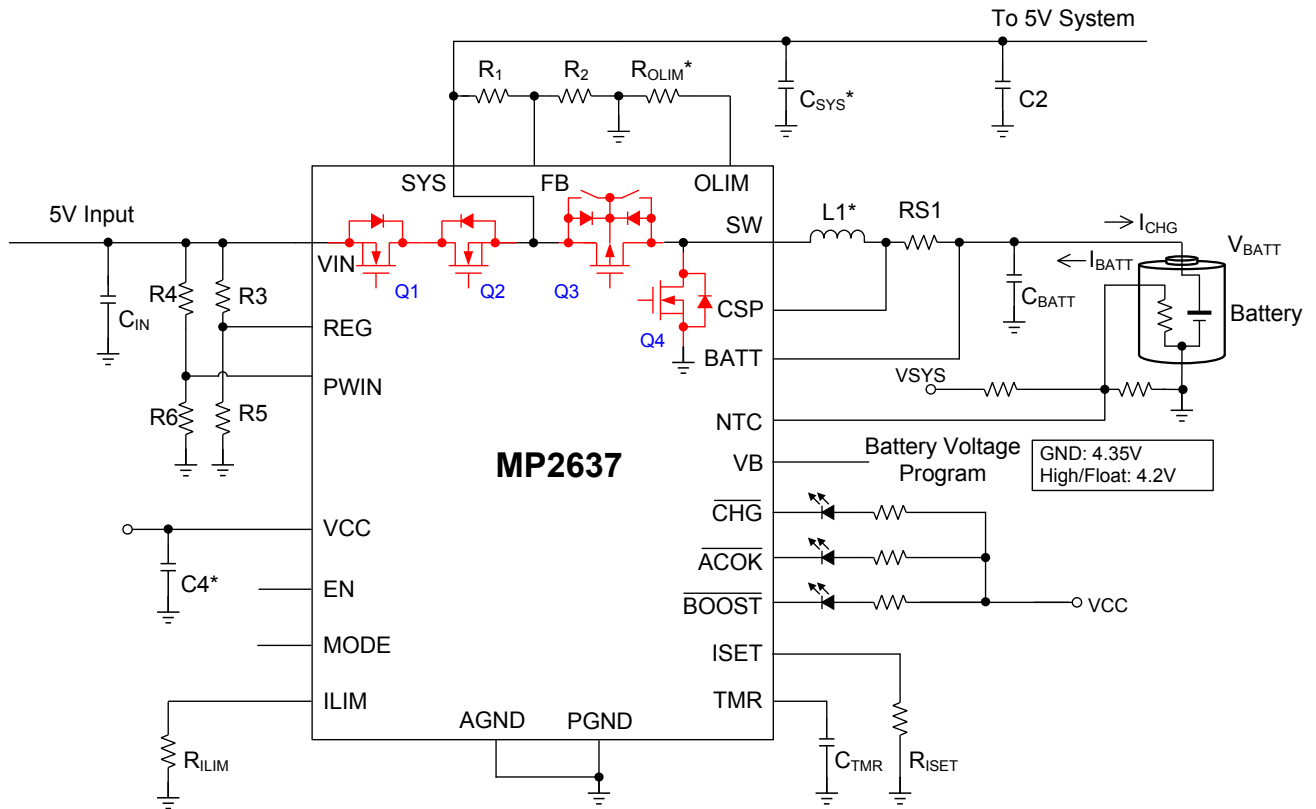

### \*Note:

1.  $R_{OLIM}$  **CANNOT** be lower than 47.5k $\Omega$ .  $R_{OLIM}$  is for the boost output current loop setting, and please refer to the **APPLICATION INFORMATION** section for details.
2.  $C_{SYS}$  should be put as close to the SYS pin and PGND as possible. At least 22 $\mu$ F is recommended, and  $C_{SYS}+C2$  should not be less than 44 $\mu$ F, the ceramic is preferred and E-cap is not recommended.
3. VCC cap should not exceed 100nF. Recommend 47nF or 100nF.
4. Inductor should not exceed 2.2 $\mu$ H. Recommend 1.5 $\mu$ H or 2.2 $\mu$ H.

**Table 1: Operation Mode**

Power Source		MODE	EN	Operating Mode	ACOK	Q1,Q2	Q3	Q4
VIN	PWIN							
$V_{IN} > V_{BATT} + 300mV$	$0.8V < PWIN < 1.15V$	X	Low	Only Pass Through Mode	Low	On	Off	Off
			High	Charging Mode		On	SW	SW
X	$PWIN < 0.8V$ or $PWIN > 1.15V$	High	X	Boost Discharge Mode	High	Off	SW	SW
$V_{IN} < V_{BATT} + 300mV$	X							
X	$PWIN < 0.8V$ or $PWIN > 1.15V$	Low	X	SYS Force-off Mode	High	Off	Off	Off
$V_{IN} < 2V$	X	Low	X	Sleep Mode	High	Off	Off	Off

X=Don't Care.

On = Fully Turn On

Off = Fully Off

SW = Switching

### ORDERING INFORMATION

Part Number*	Package	Top Marking
MP2637GR	QFN-24 (4mm×4mm)	See Below

\* For Tape & Reel, add suffix -Z (e.g. MP2637GR-Z);

### TOP MARKING

**MPSYWW**

**MP2637**

**LLLLLL**

MPS: MPS prefix;  
 Y: year code;  
 WW: week code;  
 MP2637: first six digits of the part number;  
 LLLLLL: lot number;

### PACKAGE REFERENCE

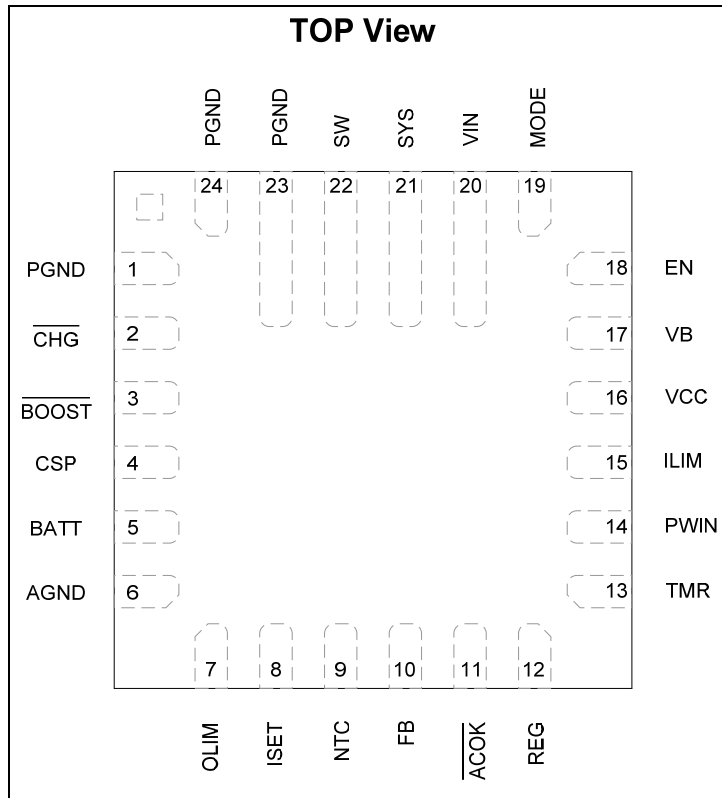



**ABSOLUTE MAXIMUM RATINGS** <sup>(1)</sup>

VIN .....	–0.3V to 20V
SYS .....	–0.3V to 6.5V
SW.....	–0.3V (-2V for <20ns) to 6.5V (8.5V for <20ns)
BATT .....	–0.3V to 6.5V
ACOK, CHG, BOOST .....	–0.3V to 6.5V
All Other Pins .....	–0.3V to 6.5V
Junction Temperature.....	150°C
Lead Temperature .....	260°C
Continuous Power Dissipation (T <sub>A</sub> = +25°C) <sup>(2)</sup>	
.....	2.97W
Junction Temperature.....	150°C
Storage Temperature.....	–65°C to +150°C

**Recommended Operating Conditions** <sup>(3)</sup>

Supply Voltage V <sub>VIN</sub> .....	4.5V to 6V
Battery Voltage V <sub>BATT</sub> .....	2.5V to 4.35V
Operating Junction Temp. (T <sub>J</sub> ).....	–40°C to +125°C

<b>Thermal Resistance</b> <sup>(4)</sup>	<b>θ<sub>JA</sub></b>	<b>θ<sub>JC</sub></b>
QFN-24 (4mm×4mm).....	42.....	9 .... °C/W

**Notes:**

- 1) Exceeding these ratings may damage the device.
- 2) The maximum allowable power dissipation is a function of the maximum junction temperature T<sub>J</sub> (MAX), the junction-to-ambient thermal resistance θ<sub>JA</sub>, and the ambient temperature T<sub>A</sub>. The maximum allowable continuous power dissipation at any ambient temperature is calculated by P<sub>D</sub> (MAX) = (T<sub>J</sub> (MAX)-T<sub>A</sub>)/θ<sub>JA</sub>. Exceeding the maximum allowable power dissipation will cause excessive die temperature, and the regulator will go into thermal shutdown. Internal thermal shutdown circuitry protects the device from permanent damage.
- 3) The device is not guaranteed to function outside of its operating conditions.
- 4) Measured on JESD51-7, 4-layer PCB.

## ELECTRICAL CHARACTERISTICS

V<sub>IN</sub> = 5.0V, T<sub>A</sub> = 25°C, unless otherwise noted.

Parameter	Symbol	Condition	Min	Typ	Max	Units
IN to SYS NMOS ON Resistance	R <sub>IN to SYS</sub>	VCC=5V,		65		mΩ
High-side PMOS ON Resistance	R <sub>H_DS</sub>	VCC=5V,		30		mΩ
Low-side NMOS ON Resistance	R <sub>L_DS</sub>	VCC=5V,		30		mΩ
High-Side PMOS Peak Current Limit	I <sub>PEAK_HS</sub>	CC Charge Mode/ Boost Mode		6.5		A
		TC Charge Mode		3.2		A
Low-Side NMOS Peak Current Limit	I <sub>PEAK_LS</sub>			6.3		A
Switching Frequency*	f <sub>sw</sub>		490	600	700	kHz
VCC UVLO	V <sub>CC_UVLO</sub>		2	2.2	2.4	V
VCC UVLO Hysteresis				100		mV
PWIN Lower Threshold	V <sub>PWIN_L</sub>		0.75	0.8	0.85	V
Lower Threshold Hysteresis				50		mV
PWIN Upper Threshold	V <sub>PWIN_H</sub>		1.1	1.15	1.2	V
Upper Threshold Hysteresis				50		mV
<b>Charge Mode</b>						
Input Quiescent Current	I <sub>IN</sub>	EN = 5V, Battery Float			2.5	mA
		EN = 0			1.5	mA
Input Current Limit	I <sub>IN_LIMIT</sub>	R <sub>LIM</sub> = 100k	400	450	500	mA
		R <sub>LIM</sub> = 56k	720	810	900	
		R <sub>LIM</sub> = 16.5k	2400	2700	3000	
Input Over-Current Threshold	I <sub>IN(OCF)</sub>			4.2		A
Input Over-Current Blanking Time <sup>(5)</sup>	T <sub>INOCBLK</sub>			120		μs
Input Over-Current Recover Time <sup>(5)</sup>	T <sub>INRECVR</sub>			100		ms
Terminal Battery Voltage	V <sub>BATT_FULL</sub>	Connect VB to GND	4.328	4.35	4.372	V
		Leave VB floating or connect to logic HIGH	4.179	4.2	4.221	
Recharge Threshold	V <sub>RECH</sub>	Connect to VB to GND	4.09	4.15	4.21	V
		Leave VB floating or connect to logic HIGH	3.95	4.01	4.07	
Recharge Threshold Hysteresis				200		mV
Battery Over Voltage Threshold		As percentage of the V <sub>BATT_FULL</sub>		103.3%		V <sub>BATT_FULL</sub>
Constant Charge (CC) Current	I <sub>CC</sub>	RS1 = 20mΩ, R <sub>ISSET</sub> = 120k	850	1000	1150	mA
		RS1 = 20mΩ, R <sub>ISSET</sub> = 60.4k	1725	1987	2250	
		RS1 = 20mΩ, R <sub>ISSET</sub> = 47.5k	2225	2525	2825	
Trickle Charge Current	I <sub>TC</sub>		125	250		mA

\* Reserve 1200kHz Option

**ELECTRICAL CHARACTERISTICS (continued)**

V<sub>IN</sub> = 5.0V, T<sub>A</sub> = 25°C, unless otherwise noted.

Parameter	Symbol	Condition	Min	Typ	Max	Units
Trickle Charge Voltage Threshold	V <sub>BATT_TC</sub>	Connect to VB to GND	3.0	3.1	3.2	V
		Leave VB floating or connect to high logic	2.9	3	3.1	
Trickle Charge Hysteresis				200		mV
Termination Charge Current	I <sub>BF</sub>	RS1 = 20mΩ, R <sub>ISSET</sub> =60.4k	2.5%	10%	17.5%	I <sub>CC</sub>
		RS1 = 20mΩ, R <sub>ISSET</sub> =47.5k	2.5%	10%	17.5%	I <sub>CC</sub>
Input-Voltage-Regulation Reference	V <sub>REG</sub>		1.18	1.2	1.22	V
<b>Boost Mode</b>						
SYS Voltage Range			4.2		6	V
Feedback Voltage			1.18	1.2	1.22	V
Feedback Input Current		V <sub>FB</sub> =1V			200	nA
Boost SYS Over-Voltage Protection Threshold	V <sub>SYS(OVP)</sub>	Threshold over V <sub>SYS</sub> to turn off the converter during boost mode	5.6	5.75	5.9	V
SYS Over Voltage Protection Threshold Hysteresis		V <sub>SYS</sub> falling from V <sub>SYS(OVP)</sub>		125		mV
Boost Quiescent Current		I <sub>SYS</sub> = 0, MODE = 5V			1.4	mA
Programmable Boost Output Current Limit Accuracy	I <sub>OLIM</sub>	RS1 = 20mΩ, R <sub>OLIM</sub> = 57.6k	1.875	2.083	2.290	A
		RS1 = 20mΩ, R <sub>OLIM</sub> = 51k	2.1			
SYS Over-Current Blanking Time <sup>(5)</sup>	T <sub>SYSOCBLK</sub>			120		μs
SYS Over-Current Recover Time <sup>(5)</sup>	T <sub>SYSRECVR</sub>			1		ms
Weak-Battery Threshold	V <sub>BATT(LOW)</sub>	During boosting		2.5		V
		Before Boost starts		2.9	3.05	V
<b>Sleep Mode</b>						
Battery Leakage Current	I <sub>LEAKAGE</sub>	V <sub>BATT</sub> = 4.2V, SYS Float, V <sub>IN</sub> = 0V, MODE = 0V		15	30	μA
<b>Indication and Logic</b>						
ACOK, CHG, BOOST pin output low voltage		Sinking 1.5mA			400	mV
ACOK, CHG, BOOST pin leakage current		Connected to 5V			1	μA
NTC and Time-out Fault Blinking Frequency <sup>(5)</sup>		C <sub>TMR</sub> = 0.1μF, I <sub>CHG</sub> = 1A		12.5		Hz
EN Input Logic Low Voltage					0.4	V
EN Input High Voltage			1.4			V
Mode Input Logic Low Voltage					0.4	V
Mode Input Logic High Voltage			1.4			V

**ELECTRICAL CHARACTERISTICS (continued)**

V<sub>IN</sub> = 5.0V, T<sub>A</sub> = 25°C, unless otherwise noted.

Parameter	Symbol	Condition	Min	Typ	Max	Units
<b>Protection</b>						
Trickle Charge Time		C <sub>TMR</sub> =0.1μF, remains in TC Mode, I <sub>TC</sub> = 100mA test mode		26		Min
Total Charge Time		C <sub>TMR</sub> =0.1μF, I <sub>CHG</sub> = 1A		336		Min
NTC Low Temp, Rising Threshold		R <sub>NTC</sub> =NCP18XH103(0°C)	65.6%	66.6%	67.6%	V <sub>sys</sub>
NTC Low Temp, Rising Threshold Hysteresis			1%			
NTC High Temp, Rising Threshold		R <sub>NTC</sub> =NCP18XH103(50°C)	34%	35%	36%	
NTC High Temp, Rising Threshold Hysteresis			1%			
Charging Current Foldback Threshold <sup>(5)</sup>		Charge Mode		120		°C
Thermal Shutdown Threshold <sup>(5)</sup>				150		°C

**Notes:**

5) Guaranteed by design.



## TYPICAL CHARACTERISTICS

$C_{IN} = C_{BATT} = C_{SYS} = C2 = 22\mu F$ ,  $L1 = 2.2\mu H$ ,  $RS1 = 20m\Omega$ ,  $C4 = C_{TMR} = 0.1\mu F$ , Battery Simulator, unless otherwise noted.

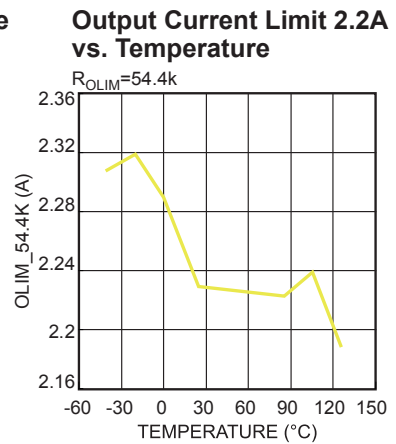
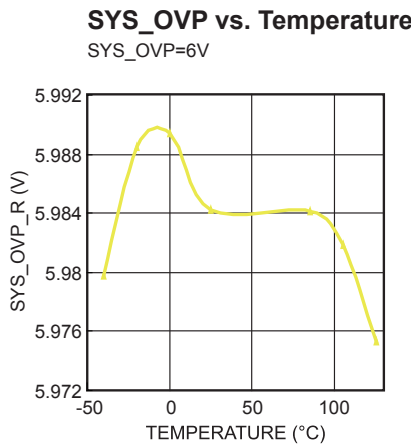
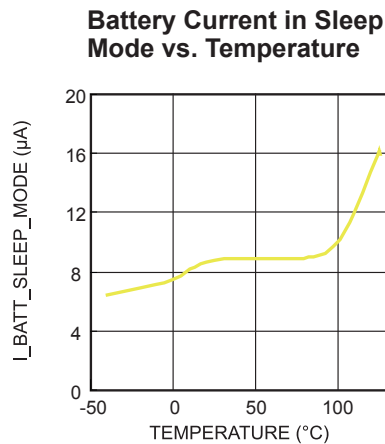
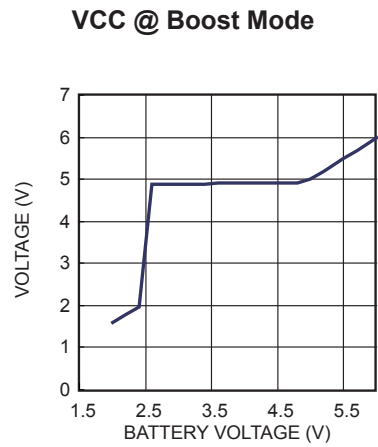
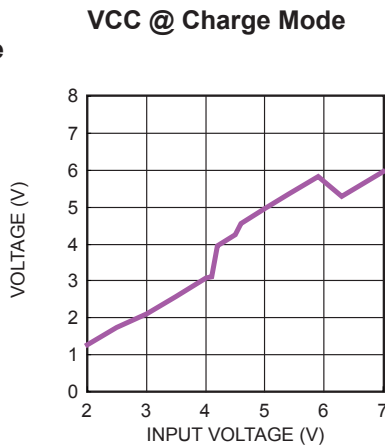
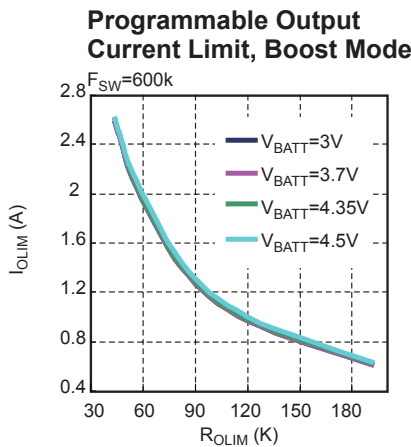
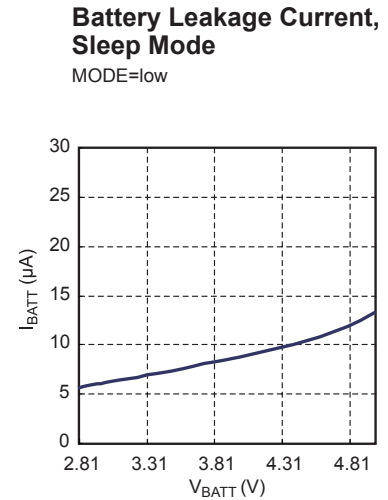
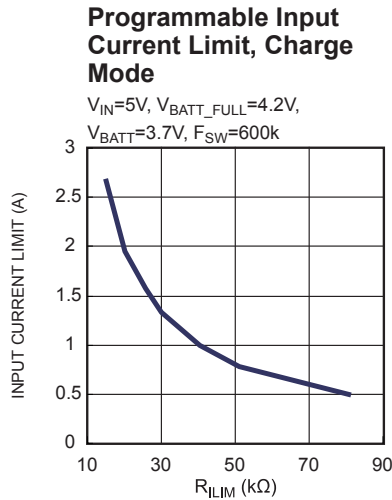
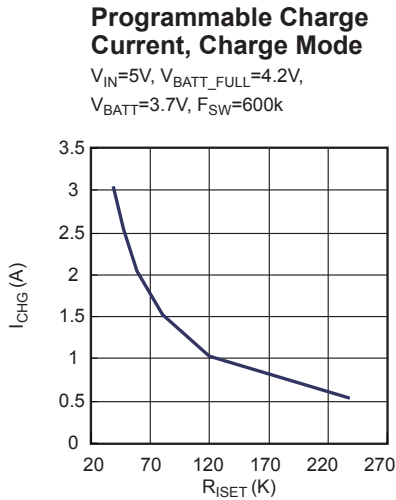

**TYPICAL CHARACTERISTICS (continued)**

$C_{IN} = C_{BATT} = C_{SYS} = C_2 = 22\mu F$ ,  $L_1 = 2.2\mu H$ ,  $RS1 = 20m\Omega$ ,  $C_4 = C_{TMR} = 0.1\mu F$ , Battery Simulator, unless otherwise noted.

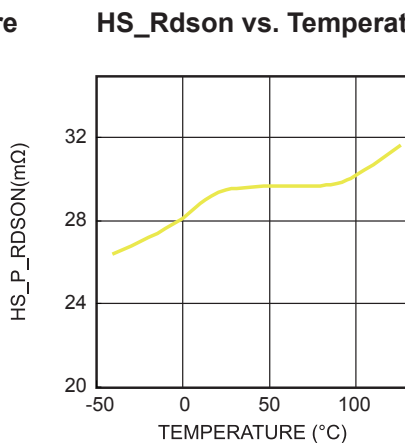
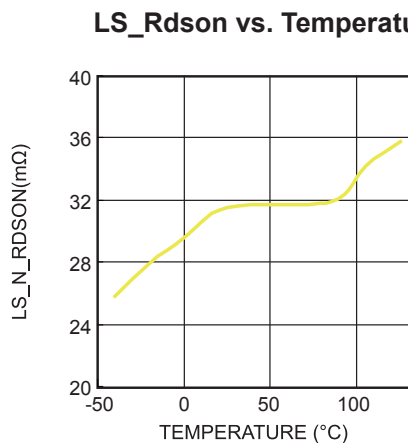
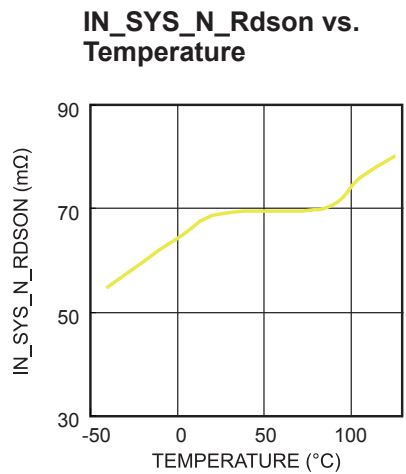
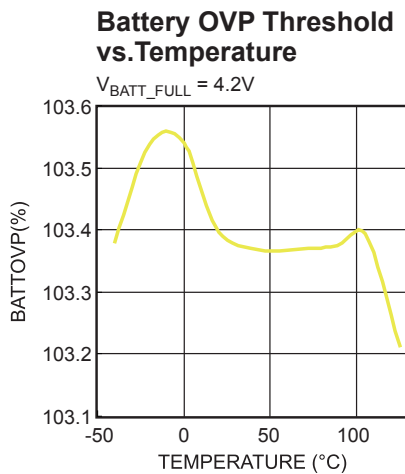
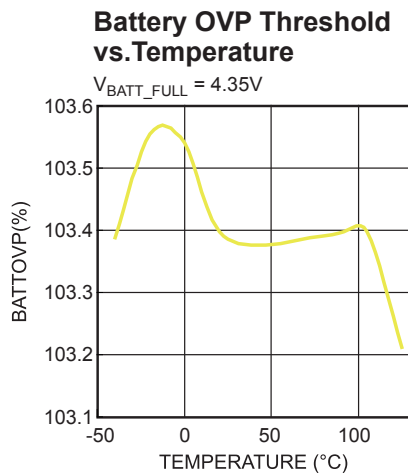
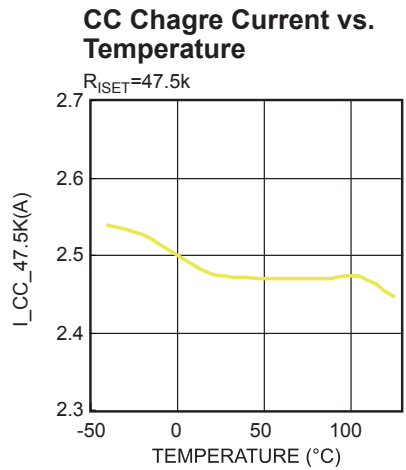
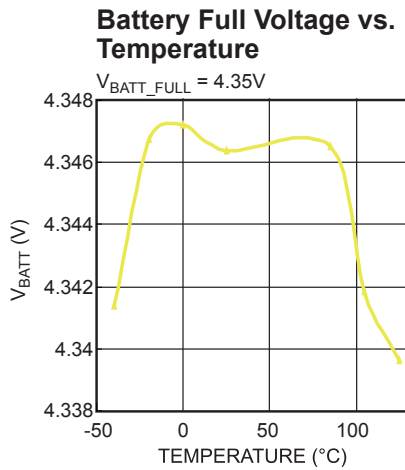
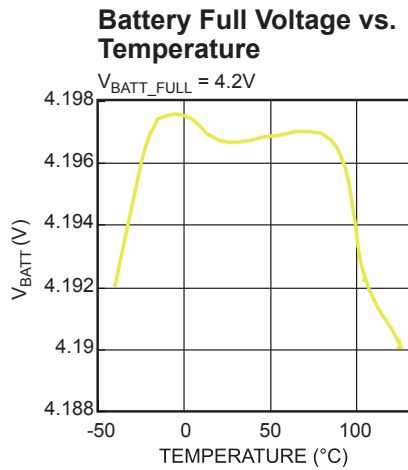

## TYPICAL PERFORMANCE CHARACTERISTICS

**For Charge Mode:**  $V_{IN} = 5V$ ,  $I_{CHG} = 2.5A$ ,  $L_{IN\_LIM} = 2.7A$ ,  $I_{SYS} = 0A$

**For Boost Mode:**  $V_{BATT} = 3.7V$ ,  $V_{SYS\_SET} = 5V$ ,  $I_{OLIM} = 2.1A$

$C_{IN} = C_{BATT} = C_{SYS} = C_2 = 22\mu F$ ,  $L_1 = 2.2\mu H$ ,  $RS1 = 20m\Omega$ ,  $C_4 = C_{TMR} = 0.1\mu F$ , Battery Simulator, unless otherwise noted.

**Battery Charge Curve**

$V_{BATT\_FULL} = 4.2V$

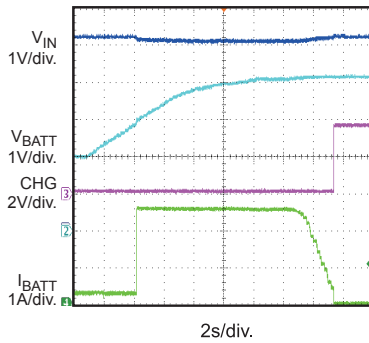

**Auto Recharge**

$V_{BATT\_FULL} = 4.2V$

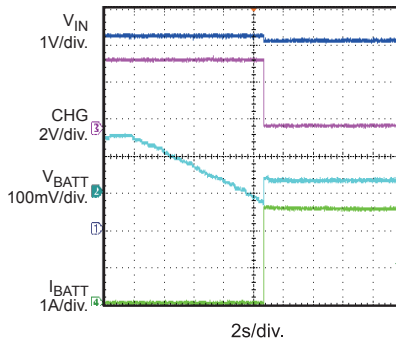

**Battery Float Steady State**

$V_{BATT\_FULL} = 4.2V$

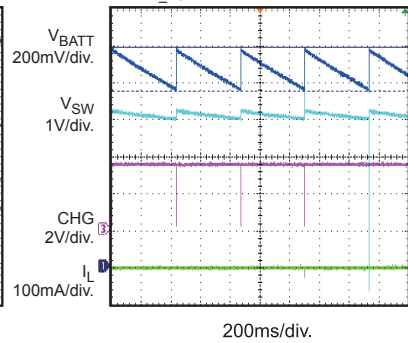

**TC Charge Steady State**

$V_{BATT\_FULL} = 4.2V$ ,  $V_{BATT} = 2V$ ,  $f_{SW} = 600KHz$

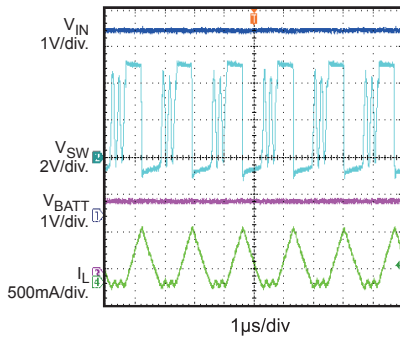

**CC Charge Steady State**

$V_{BATT\_FULL} = 4.2V$ ,  $V_{BATT} = 3.7V$ ,  $f_{SW} = 600KHz$

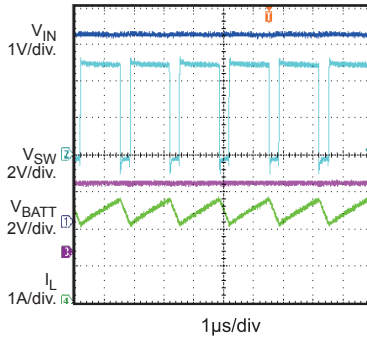

**CV Charge Steady State**

$V_{BATT\_FULL} = 4.2V$ ,  $V_{BATT} = 4.2V$ ,  $f_{SW} = 600KHz$

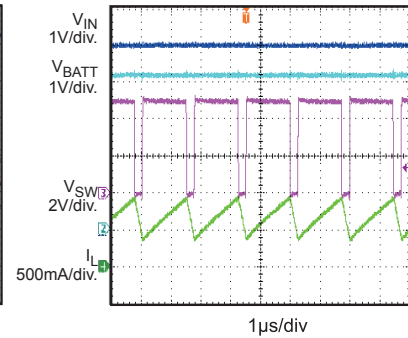

**Constant Current Charge Efficiency**

$V_{BATT\_FULL} = 4.2V$ ,  $V_{BATT} = 0.5-4.2V$ ,  $f_{SW} = 600KHz$

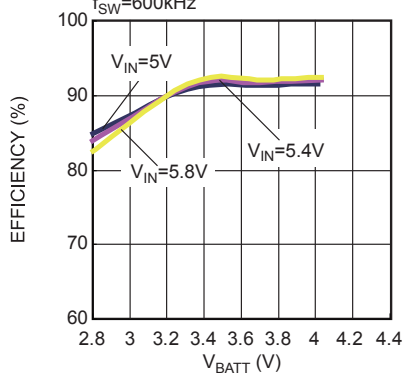

**Constant Voltage Charge Efficiency**

$V_{BATT\_FULL} = 4.2V$ ,  $V_{BATT} = 4.2V$ ,  $f_{SW} = 600KHz$

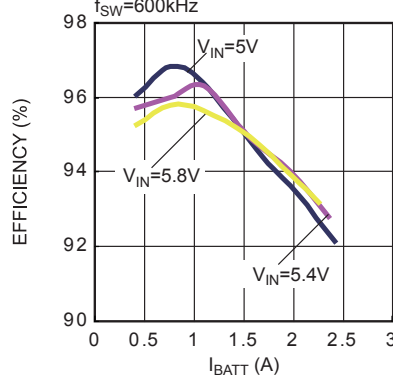

**TYPICAL PERFORMANCE CHARACTERISTICS (continued)**

**For Charge Mode:**  $V_{IN} = 5V$ ,  $I_{CHG} = 2.5A$ ,  $L_{IN\_LIM} = 2.7A$ ,  $I_{SYS} = 0A$

**For Boost Mode:**  $V_{BATT} = 3.7V$ ,  $V_{SYS\_SET} = 5V$ ,  $I_{OLIM} = 2.1A$

$C_{IN} = C_{BATT} = C_{SYS} = C_2 = 22\mu F$ ,  $L_1 = 2.2\mu H$ ,  $RS1 = 20m\Omega$ ,  $C_4 = C_{TMR} = 0.1\mu F$ , Battery Simulator, unless otherwise noted.

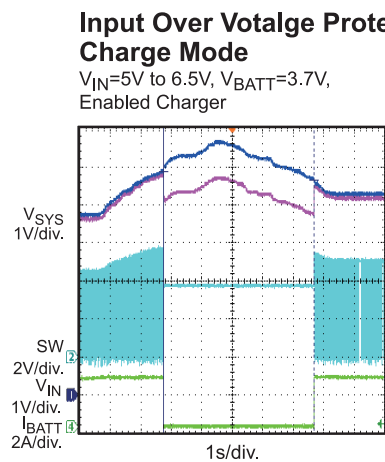
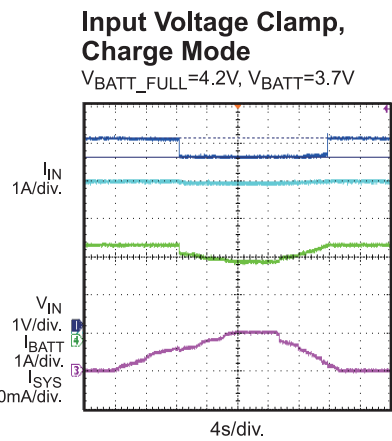
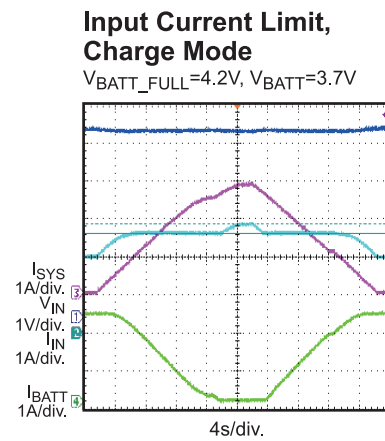
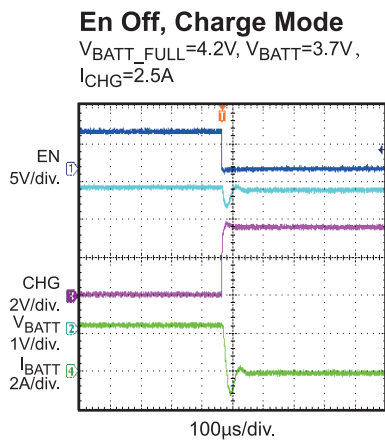
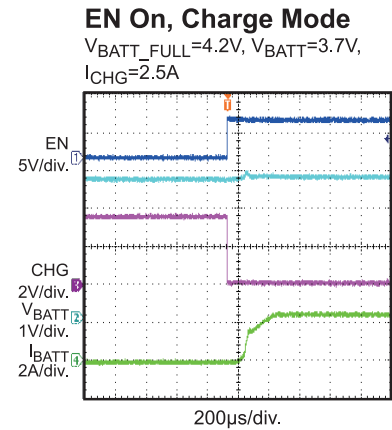
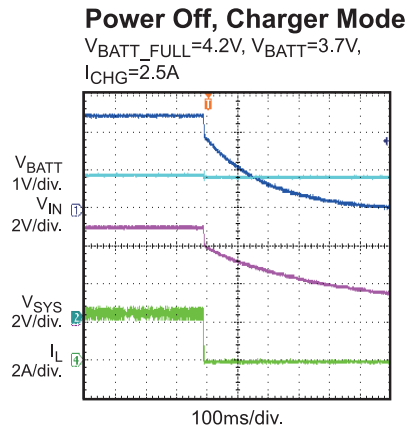
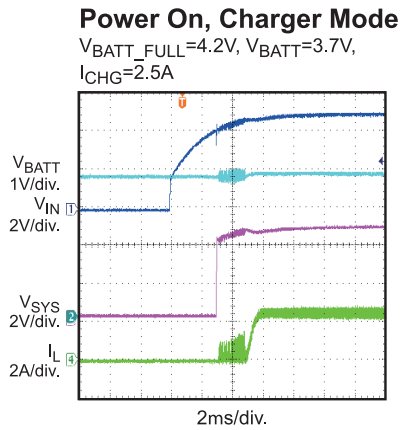

**TYPICAL PERFORMANCE CHARACTERISTICS (continued)**

**For Charge Mode:**  $V_{IN} = 5V$ ,  $I_{CHG} = 2.5A$ ,  $L_{IN\_LIM} = 2.7A$ ,  $I_{SYS} = 0A$

**For Boost Mode:**  $V_{BATT} = 3.7V$ ,  $V_{SYS\_SET} = 5V$ ,  $I_{OLIM} = 2.1A$

$C_{IN} = C_{BATT} = C_{SYS} = C_2 = 22\mu F$ ,  $L_1 = 2.2\mu H$ ,  $RS1 = 20m\Omega$ ,  $C_4 = C_{TMR} = 0.1\mu F$ , Battery Simulator, unless otherwise noted.

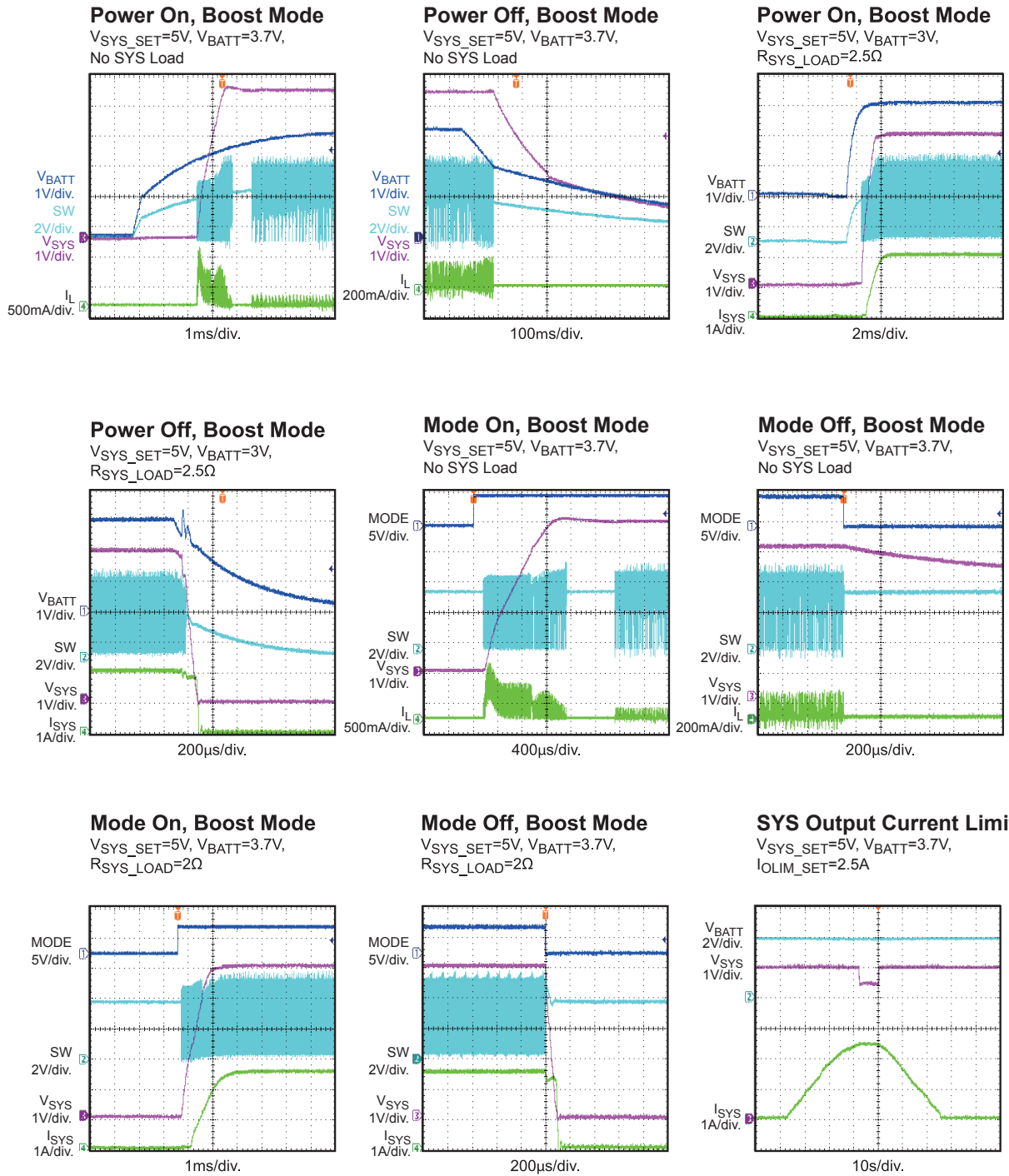

**TYPICAL PERFORMANCE CHARACTERISTICS (continued)**

**For Charge Mode:**  $V_{IN} = 5V$ ,  $I_{CHG} = 2.5A$ ,  $L_{IN\_LIM} = 2.7A$ ,  $I_{SYS} = 0A$

**For Boost Mode:**  $V_{BATT} = 3.7V$ ,  $V_{SYS\_SET} = 5V$ ,  $I_{OLIM} = 2.1A$

$C_{IN} = C_{BATT} = C_{SYS} = C_2 = 22\mu F$ ,  $L_1 = 2.2\mu H$ ,  $RS1 = 20m\Omega$ ,  $C_4 = C_{TMR} = 0.1\mu F$ , Battery Simulator, unless otherwise noted.

**SYS Short Circuit Entry**

$V_{SYS\_SET}=5V$ ,  $V_{BATT}=3.7V$

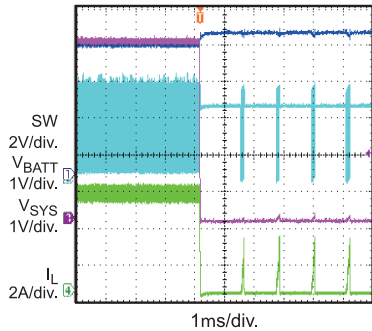

**SYS Short Circuit Recovery**

$V_{SYS\_SET}=5V$ ,  $V_{BATT}=3.7V$ ,

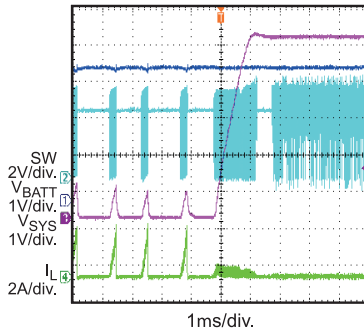

**SYS Over Voltage Protection**

$V_{SYS\_SET}=6.5V$ ,  $V_{BATT}=3.7V$

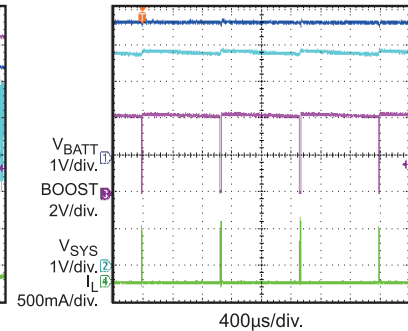

**SYS Load Transient**

$V_{SYS\_SET}=5V$ ,  $V_{BATT}=3V$ ,  
 $I_{SYS} = 80mA$  to  $1A$

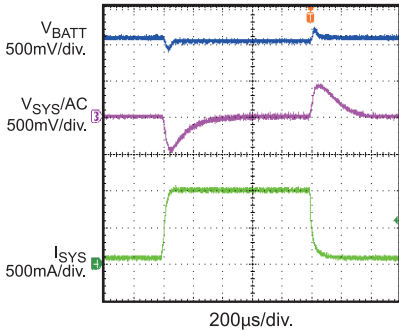

**SYS Load Transient**

$V_{SYS\_SET}=5V$ ,  $V_{BATT}=3.7V$ ,  
 $I_{SYS} = 1A$  to  $2.2A$

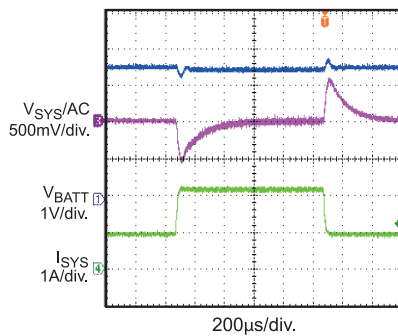

**SYS Load Transient**

$V_{SYS\_SET}=5V$ ,  $V_{BATT}=3.7V$ ,  
 $I_{SYS} = 0.3A$  to  $2.2A$

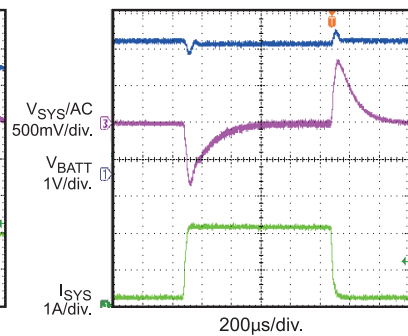

**Efficiency**

$V_{SYS\_SET}=5V$ ,  $V_{SYS}=5V$ ,  $F_S=600kHz$

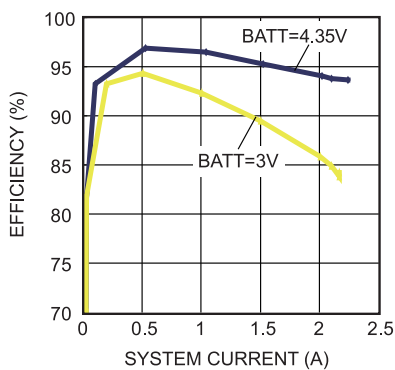

**Boost Output V-I Curve**

$V_{BATT}=3.7V$ ,  $V_{SYS}=5V$

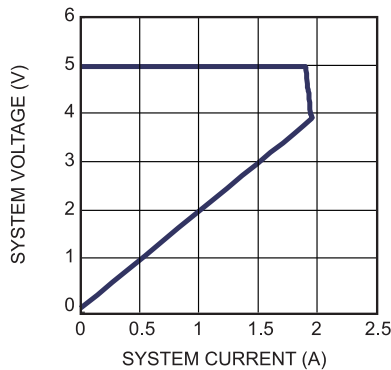

**Programmable Output Currentlimit vs. Battery**

$R_{OLIM}=59k\Omega$ ,  $V_{SYS}=5V$

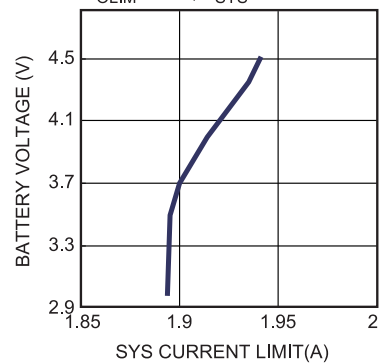

## PIN FUCTIONS

Pin #	Name	Description
1, 23, 24	PGND	Power Ground.
2	CHG	Charge Completion Indicator. Logic LOW indicates charge mode. This is an open drain pin during charge complete or suspended
3	BOOST	Boost Mode indicator. Logic LOW indicates boost mode in operation. This is an open drain pin during charge mode or sleep mode operation.
4	CSP	Battery Charge Current Sense Positive Input.
5	BATT	Positive Battery Terminal / Battery Charge Current Sense Negative Input.
6	AGND	Analog Ground
7	OLIM	Programmable Output-Current Limit for boost mode. Connect an external resistor to GND to program the system current in boost mode. The R <sub>OLIM</sub> <b>CANNOT</b> be lower than 47.5kΩ.
8	ISET	Programmable Charge Current Pin. Connect an external resistor to GND to program the charge current.
9	NTC	Negative Temperature Coefficient (NTC) Thermistor.
10	FB	System voltage feedback input.
11	ACOK	Valid Input Supply Indicator. Logic LOW on this pin indicates the presence of a valid power supply.
12	REG	Input Voltage Feedback for input voltage regulation loop. Connect to tap of an external resistor divider from VIN to GND to program the input voltage regulation. Once the voltage at REG pin drops to the inner threshold, the charge current is reduced to maintain the input voltage at the regulation value.
13	TMR	Oscillator Period Timer. Connect a timing capacitor between this pin and GND to set the oscillator period. Short to GND to disable the Timer function.
14	PWIN	Input pin to detect the presence of valid input power. Pulling this pin to GND will turn off the IN-to-SYS pass through MOSFET
15	ILIM	Input Current Set. Connect to GND with an external resistor to program input current limit in charge mode.
16	VCC	Internal Circuit Power Supply. Bypass this pin to GND with a ceramic capacitor not higher than 100nF. This pin <b>CANNOT</b> carry external load higher than 5mA.
17	VB	Programmable Battery-Full Voltage. Leave floating or connect to logic HIGH for 4.2V, while connect to GND for 4.35V.
18	EN	Charge Control Input. Logic HIGH enables charging. Logic LOW disables charging. Active only when $\overline{ACOK}$ is low (input power is OK).
19	MODE	Mode Select. Logic HIGH→boost mode. Logic LOW→sleep mode. Active only when $\overline{ACOK}$ is HIGH (input power is not available).
20	VIN	Adapter Input. Place a bypass capacitor close to this pin to prevent large input voltage spikes.
21	SYS	System Output. A minimum of 22uF ceramic cap is required to be placed as close as possible to the SYS and PGND pins. Total capacitance should not be lower than 44uF
22	SW	Switch Output Node. It is recommended not to place Via's on the SW plane during PCB layout

**BLOCK DIAGRAM**

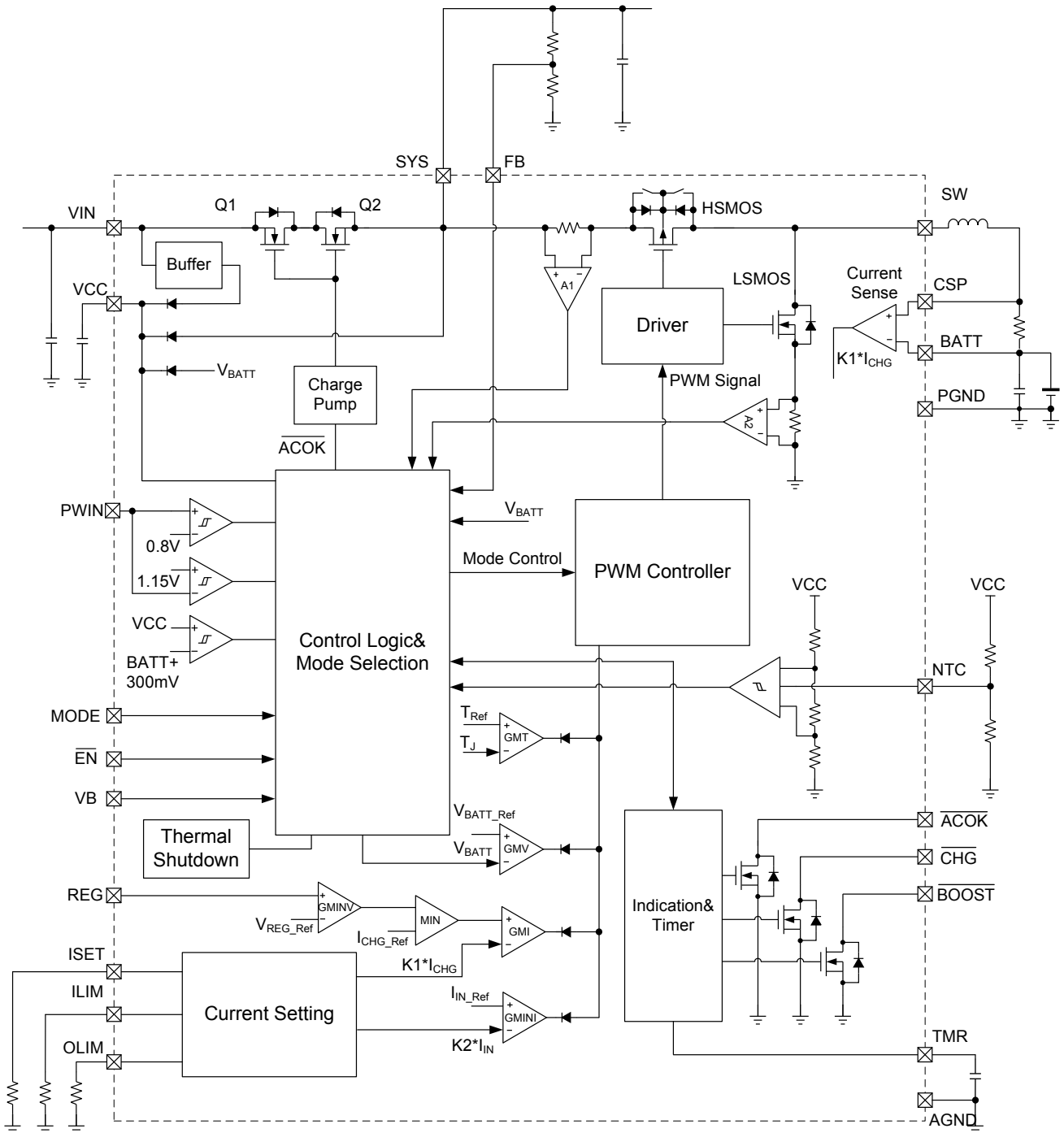

**Figure 1: Functional Block Diagram in Charge Mode**



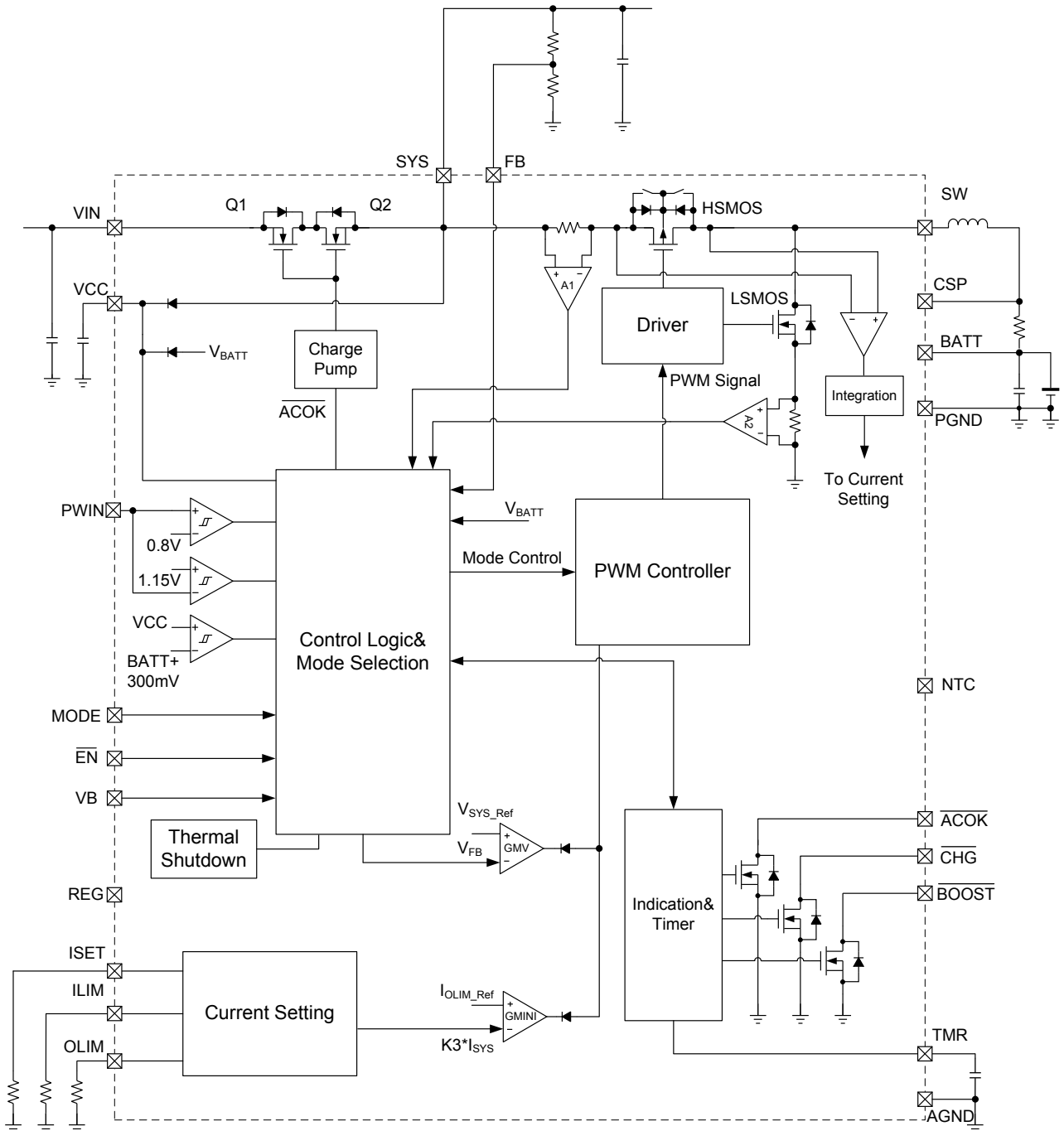

**Figure 2: Functional Block Diagram in Boost Mode**

**OPERATION FLOW CHART**

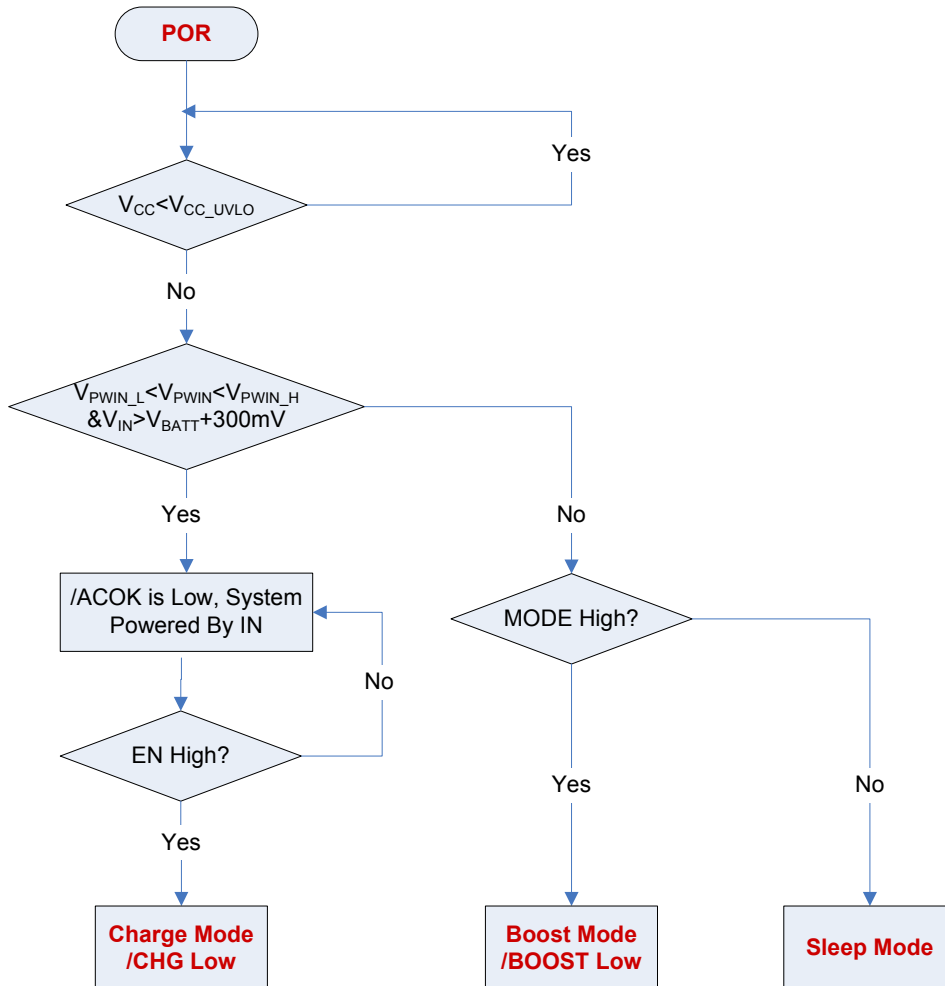

**Figure 3: Mode Selection Flow Chart**

OPERATION FLOW CHART (continued)

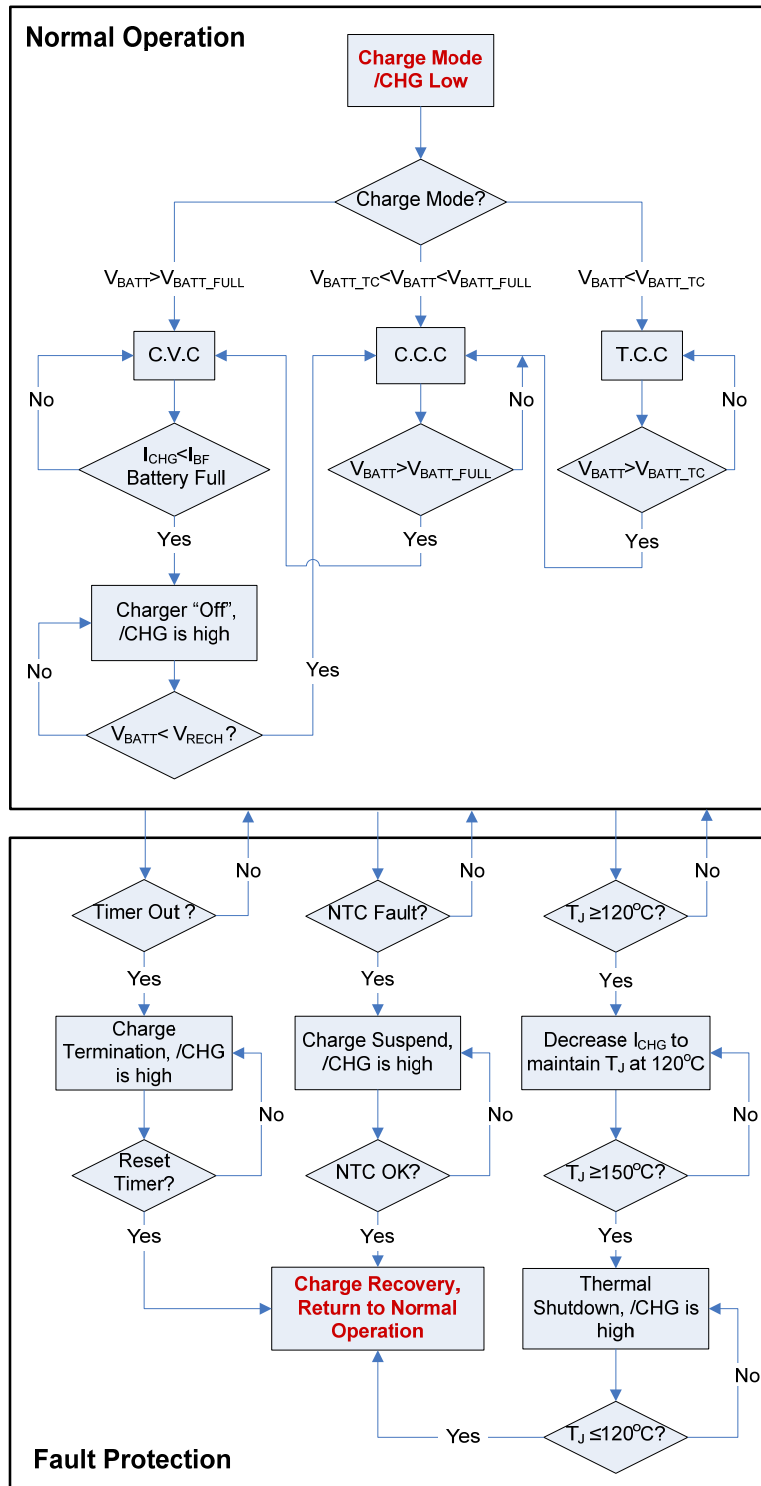

Figure 4: Normal Operation and Fault Protection in Charge Mode

OPERATION FLOW CHART (continued)

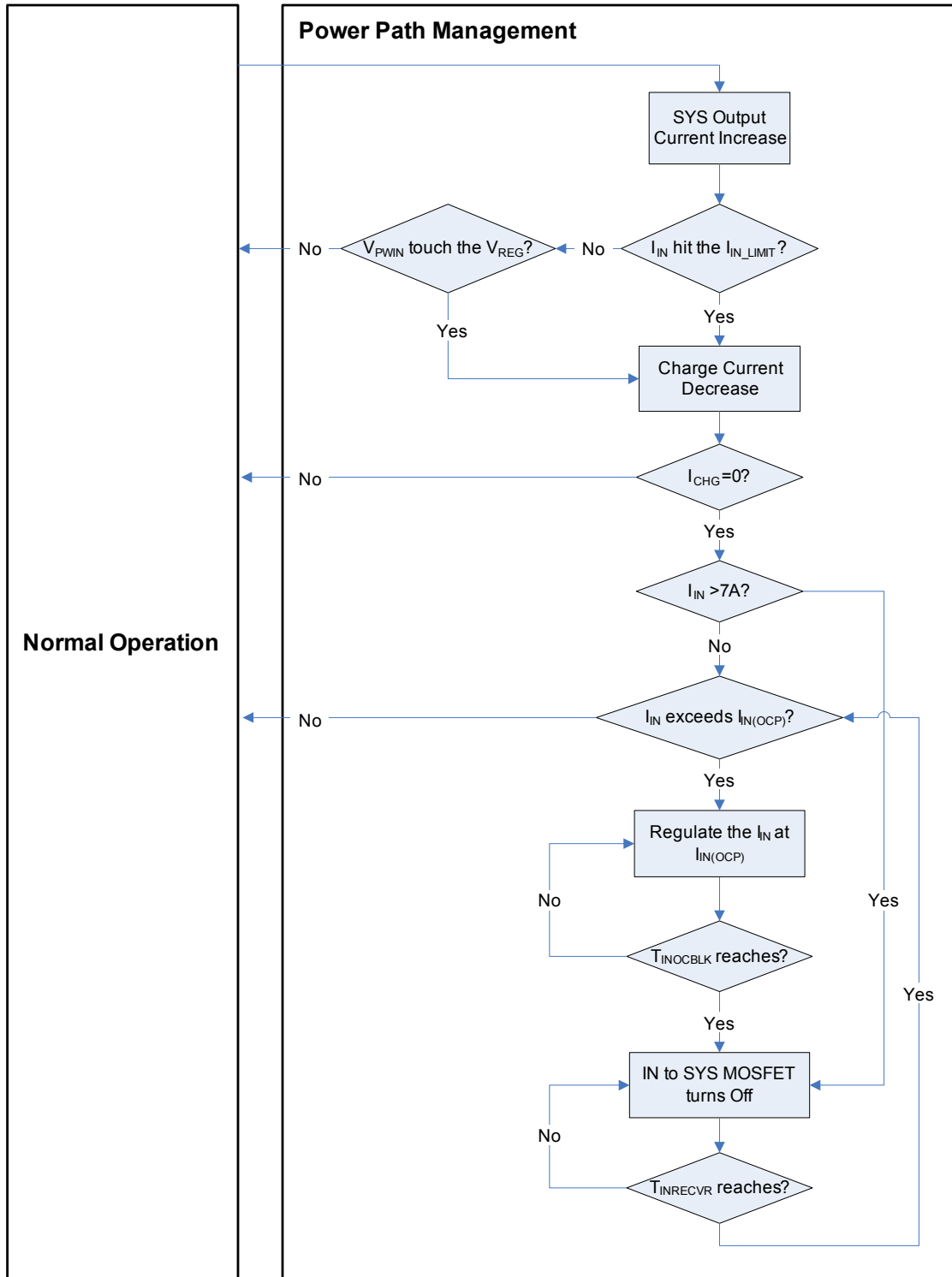
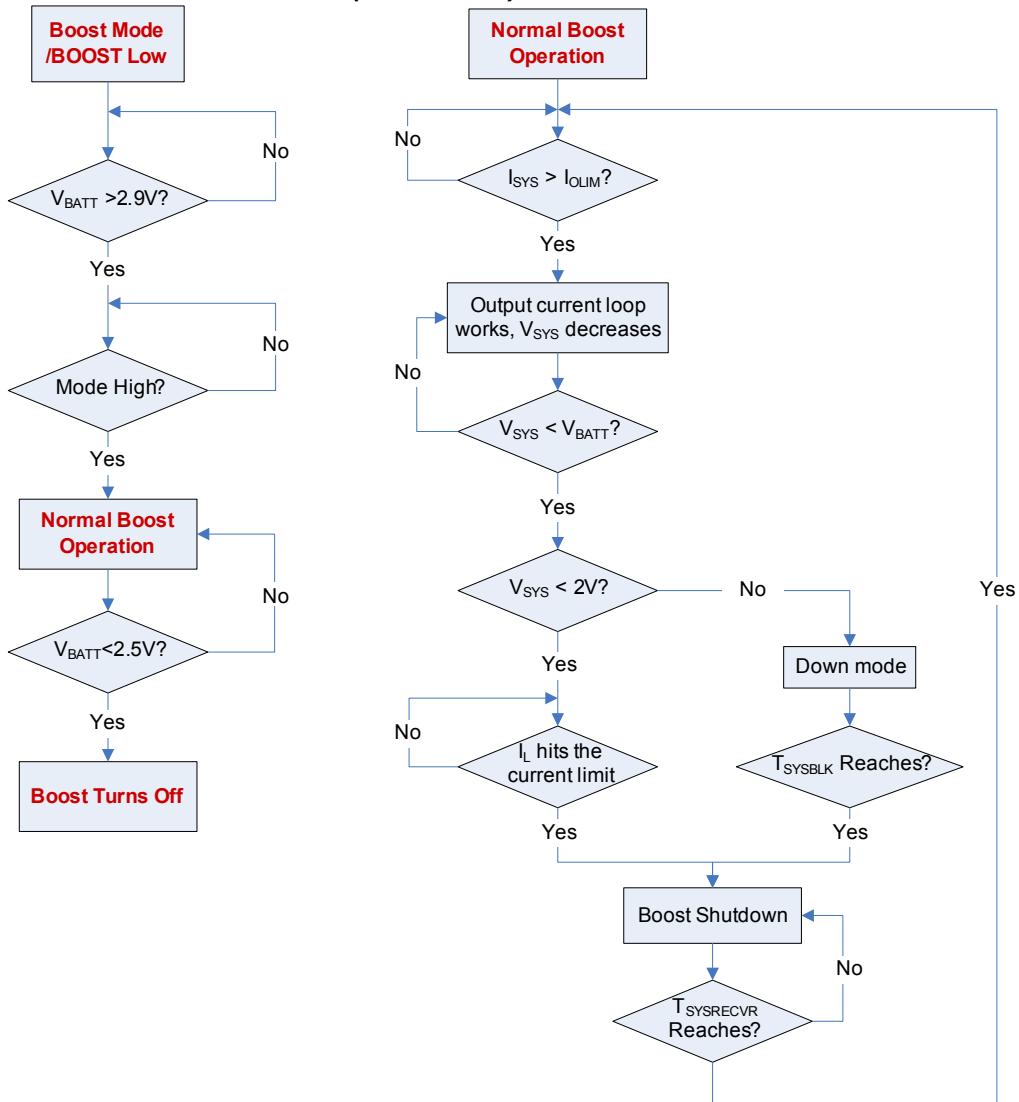

Figure 5: Power-path Management in Charge Mode

**OPERATION FLOW CHART (continued)**



**Figure 6: Operation Flow Chart in Boost Mode**

**START UP TIME FLOW IN CHARGE MODE**

Condition: EN = 5V, Mode = 0V, /ACOK and /CHG are always pulled up to an external 5V.

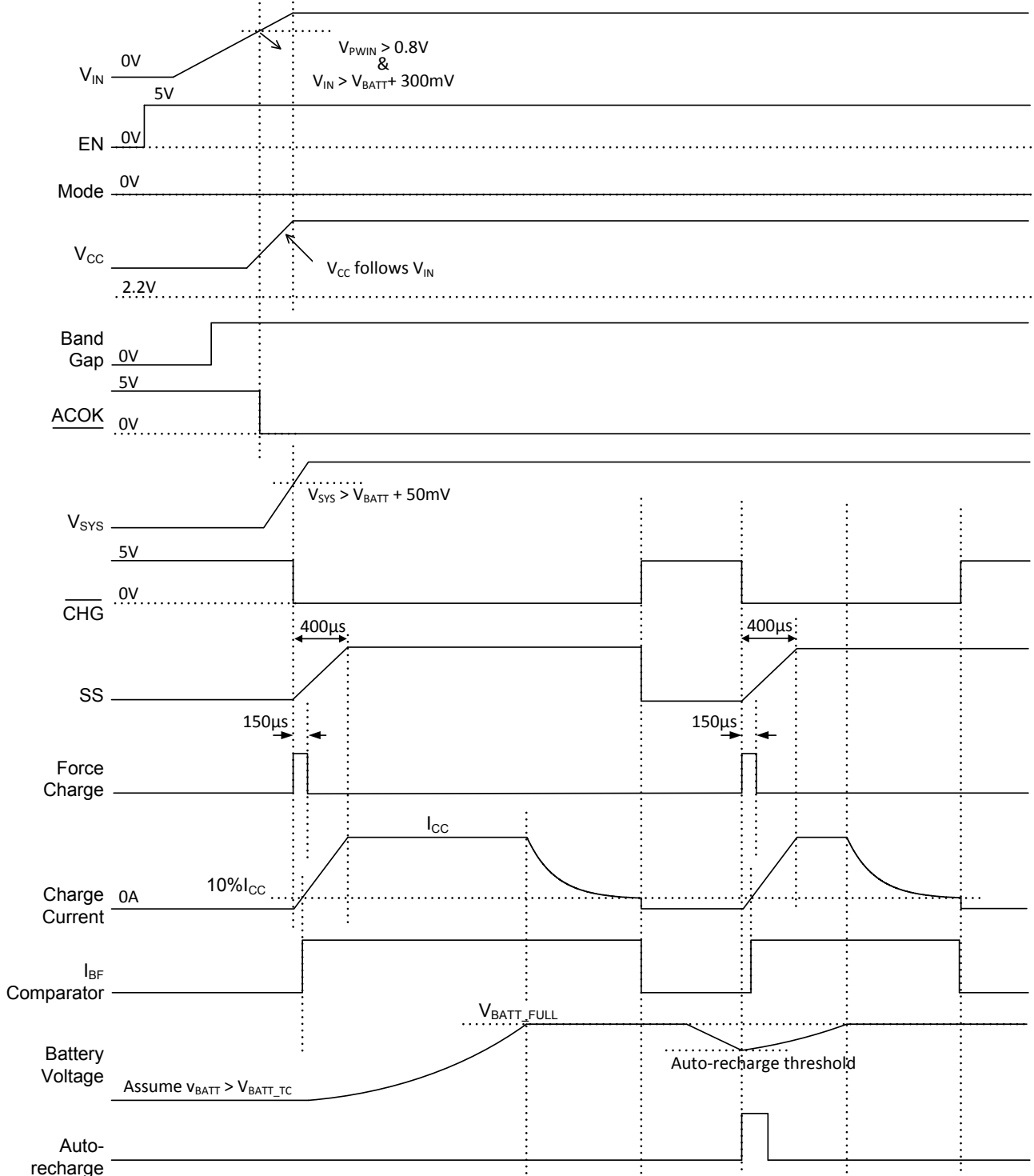

**Figure 7: Input Power Start-Up Time Flow in Charge Mode**

### START UP TIME FLOW IN CHARGE MODE

Condition: EN = 5V, Mode = 0V, /ACOK and /CHG are always pulled up to an external 5V.

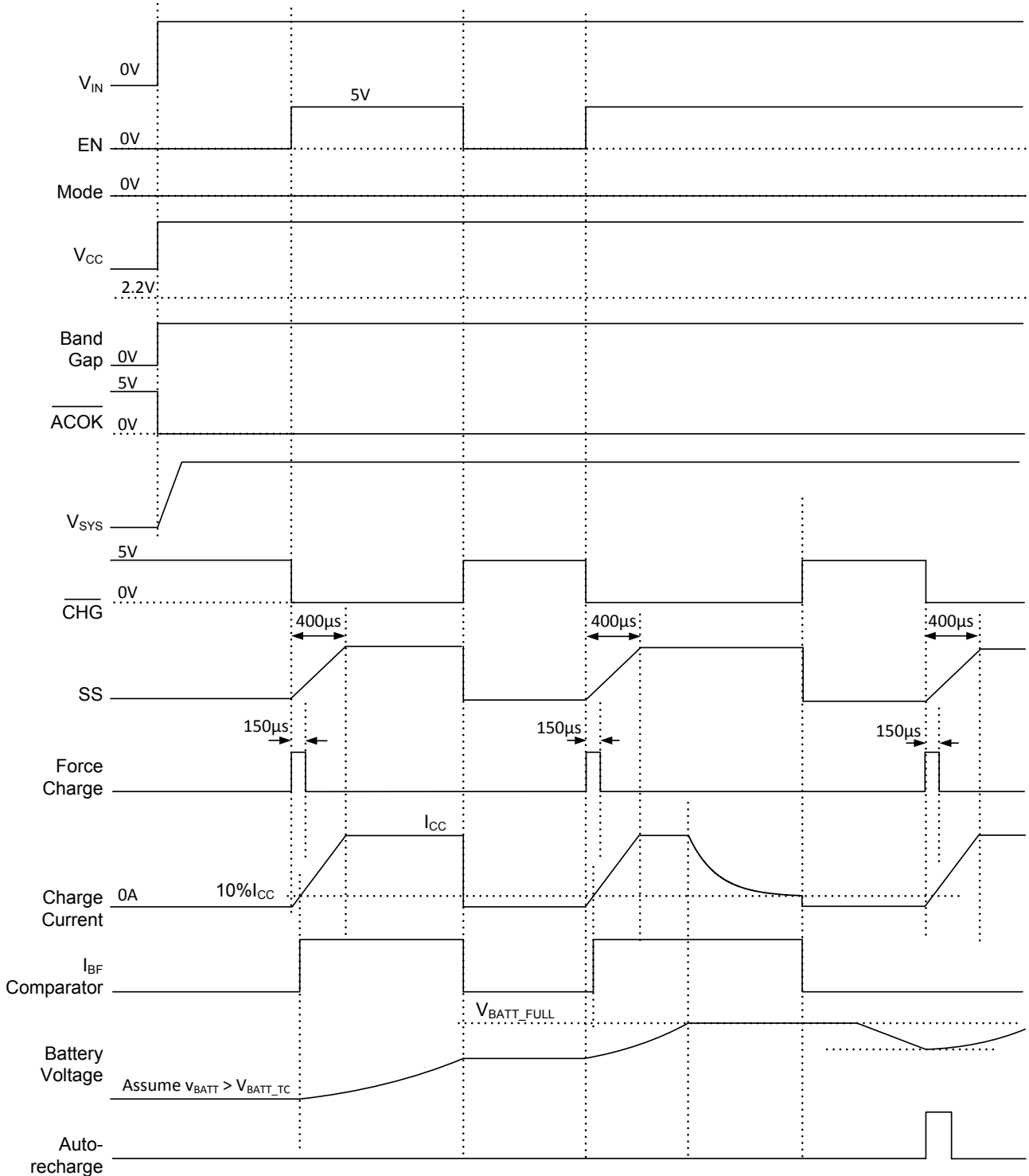
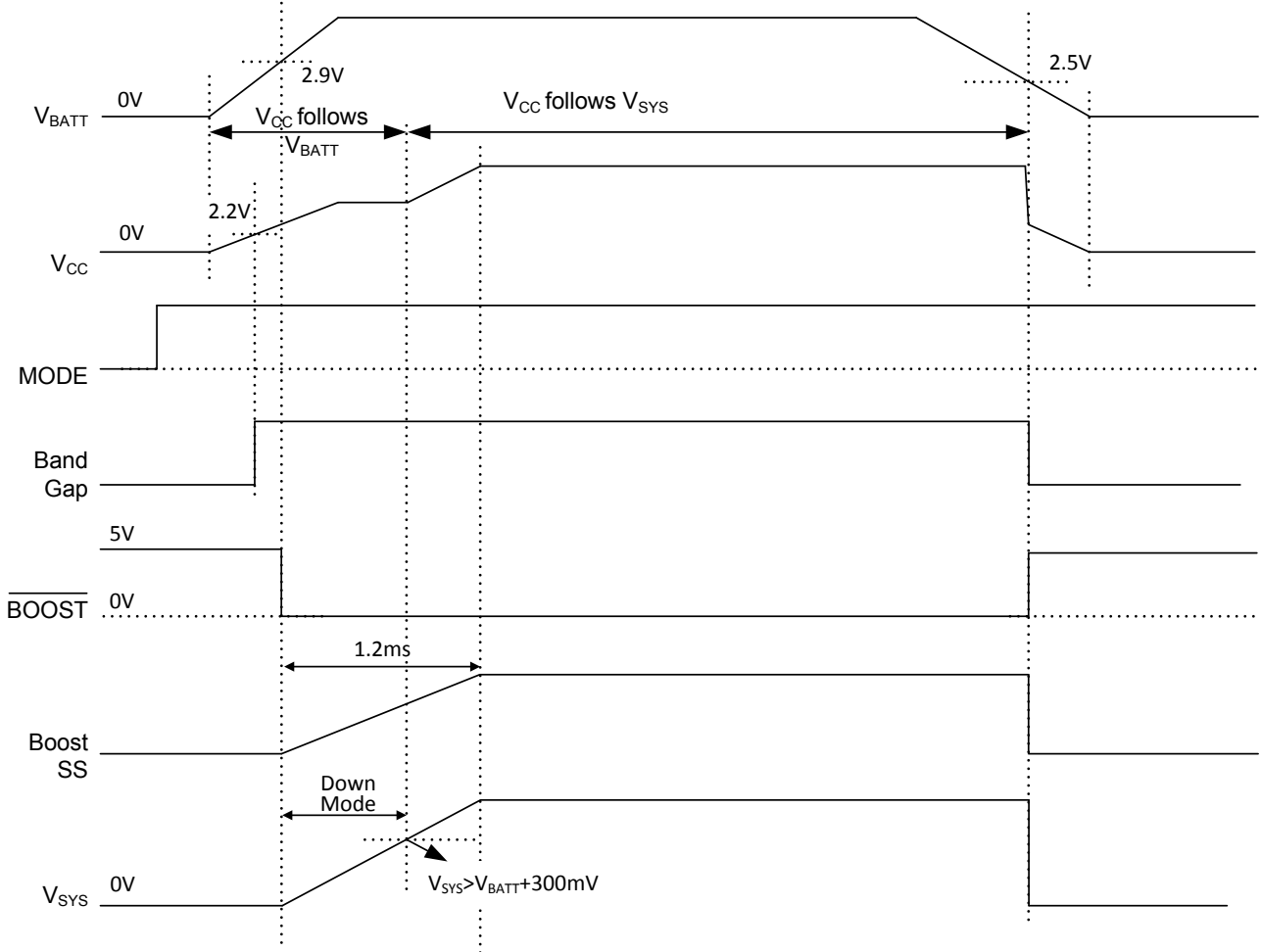

Figure 8: EN Start-Up Time Flow in Charge Mode

**START UP TIME FLOW IN BOOST MODE**

Condition:  $V_{IN} = 0V$ , Mode = 5V, /Boost is always pulled up to an external constant 5V.

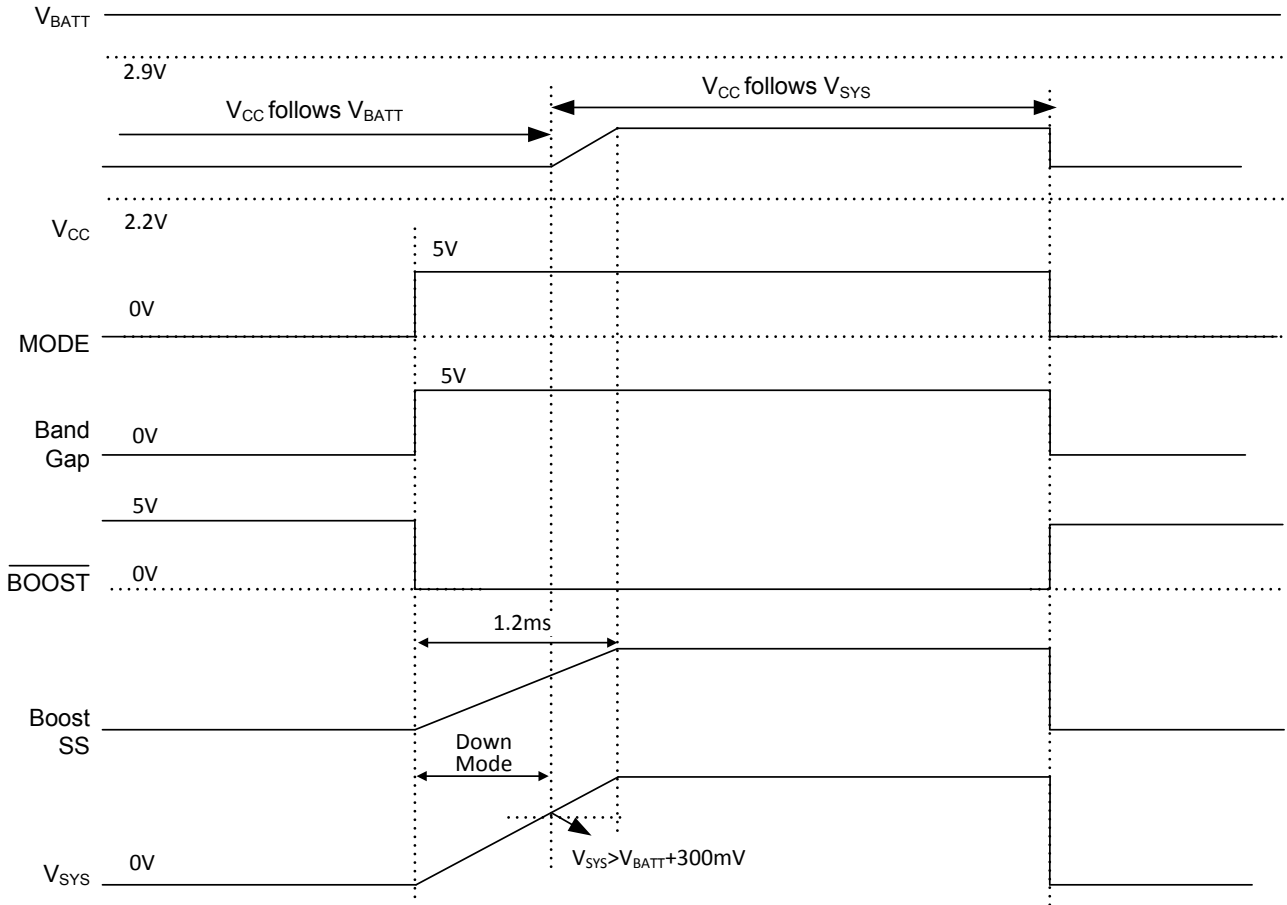

**Figure 9: Battery Power Start-Up Time Flow in Boost Mode**



### START UP TIME FLOW IN BOOST MODE

Condition:  $V_{IN} = 0V$ , /Boost is always pulled up to an external constant 5V.



**Figure 10: Mode Start-Up Time Flow in Boost Mode**

## OPERATION

### INTRODUCTION

The MP2637 is a highly-integrated, flexible, switch-mode battery charger with system power path management, designed for single-cell Li-ion or Li-Polymer batteries used in a wide range of applications. Depending on the status of the Input, the MP2637 can operate in three different modes: Charge Mode; Boost Mode; Sleep Mode.

In charge mode the MP2637 can work with a single cell Li-ion or Li-polymer battery. In boost mode the MP2637 boosts the battery voltage to  $V_{SYS\_SET}$  to power higher voltage system rails. In sleep mode both charging and boost operations are disabled and the device enters a power saving mode to help reduce the overall power consumption. The MP2637 monitors  $V_{IN}$  to allow smooth transition between different modes of operation.

### CHARGE MODE OPERATION

#### Charge Cycle (Trickle Charge → CC Charge → CV Charge)

In charge mode, the MP2637 has five control loops to regulate the input current, input voltage, charge current, charge voltage, and device junction temperature. The MP2637 charges the battery in three phases: trickle current (TC), constant current (CC), and constant voltage (CV). While charge operation is enabled, all five loops are active but only one determines the IC behavior. A typical battery charge profile is depicted in Figure 11 (a). The charger stays in TC charge mode until the battery voltage reaches a TC-to-CC threshold. Otherwise the charger enters CC charge mode. When the battery voltage rises to the CV-mode threshold, the charger operates in constant voltage mode. Figure (b) shows a typical charge profile when the input-current-limit loop dominates during the CC charge mode, and in this case the charger maximizes the charging current due to the switching-mode charging solution, resulting in faster charging than a traditional linear solution.

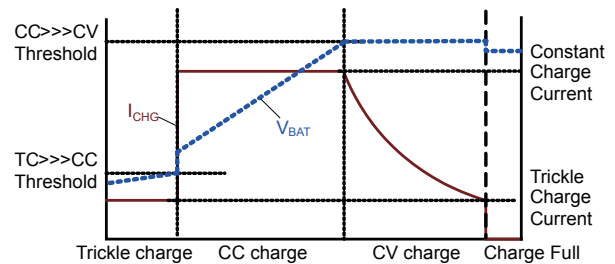

a) Without input current limit

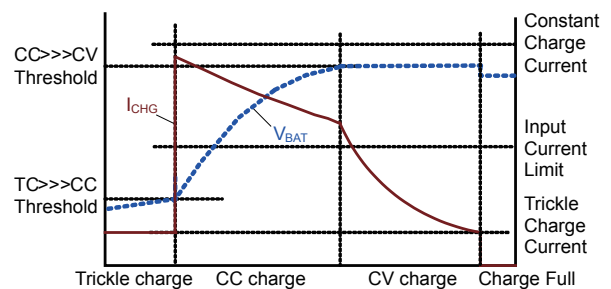

b) With input current limit

**Figure 11: Typical Battery Charge Profile**

#### Auto-recharge

Once the battery charge cycle is completed, the charger remains off. During this time, the system load may consume battery power, or the battery may self discharge. To ensure the battery will not go into depletion, a new charge cycle automatically begins when the battery voltage falls below the auto-recharge threshold and the input power is present. The timer is reset when the auto-recharge cycle begins.

During the off state after the battery is fully charged, if the input power re-starts or the EN signal refreshes, the charge cycle will start and the timer will reset no matter what the battery voltage is.

#### Battery Over-Voltage Protection

The MP2637 has battery over-voltage protection. If the battery voltage exceeds the battery over-voltage threshold, (103.3% of the battery-full voltage), charging is disabled. Under this condition, an internal 5kΩ dummy load draws a

current from the BATT pin to decrease the battery voltage and protect the battery.

### Timer Operation in Charge Mode

The MP2637 uses an internal timer to terminate the charging. The timer remains active during the charging process. An external capacitor between TMR and GND programs the charge cycle duration.

If charging remains in TC mode beyond the trickle-charge time,  $\tau_{TRICKLE\_TMR}$ , charging will terminate. The following equation determines the length of the trickle-charge period:

$$\tau_{TC\_TMR} = \frac{4.5 \times 10^4 \times 1.6(V) \times C_{TMR}(\mu F)}{1.25 \times I_{TC}(A) \times RS1(m\Omega) + 2(\mu A)} \text{ (s)} \quad (1)$$

The maximum total charge time is:

$$\tau_{TOTAL\_TMR} = \frac{3.4 \times 10^6 \times 1.6(V) \times C_{TMR}(\mu F)}{1.25 \times I_{CHG}(A) \times RS1(m\Omega) + 2(\mu A)} \text{ (s)} \quad (2)$$

### Negative Temperature Coefficient (NTC) Input for Battery Temperature Monitoring

The MP2637 has a built-in NTC resistance window comparator, which allows the MP2637 to monitor the battery temperature via the battery-integrated thermistor. Connect an appropriate resistor from  $V_{SYS}$  to the NTC pin and connect the thermistor from the NTC pin to GND. The resistor divider determines the NTC voltage depending on the battery temperature. If the NTC voltage falls outside of the NTC window, the MP2637 stops charging. The charger will then restart if the temperature goes back into NTC window range. Please refer to Application Information section for the appropriate resistance selection.

### Input Current Limiting in Charge Mode

The MP2637 has a dedicated pin used to program the input current limit. The current at ILIM is a fraction of the input current; the voltage at ILIM indicates the average input current of the switching regulator as determined by the resistor value between ILIM and GND. As the input current approaches the programmed input current limit, charge current is reduced to allow priority to system power.

Use the following equation to determine the input current limit threshold.

$$I_{ILIM} = \frac{45(k\Omega)}{R_{ILIM}(k\Omega)} \text{ (A)} \quad (3)$$

### Input Voltage Regulation in Charge Mode

In charge mode, if the input power source is not sufficient to support both the charge current and system load current, the input voltage will decrease. As the input voltage approaches the programmed input voltage regulation value, charge current is reduced to allow priority of system power and maintain proper regulation of the input voltage.

The input voltage can be regulated by a resistor divider from IN pin to REG pin to AGND according to the following equation:

$$V_{REG} = V_{IN\_R} \times \frac{R5}{R3 + R5} \text{ (V)} \quad (4)$$

where the  $V_{REG}$  is the internal voltage reference, 1.2V, and the  $V_{IN\_R}$  is the desired regulation voltage.

### Integrated Over Current Protection and Over Voltage Protection for Pass-through Path

The MP2637 has an integrated IN to SYS pass-through path to allow direct connection of the input voltage to the system even if charging is disabled. Based on the above, the MP2637 continuously monitors both input current and voltage. In the event of an OCP or OVP charge current will be reduced to ensure priority of the system power requirements.

In addition, the MP2637 also features input over current and voltage protection for the IN to SYS pass-through path.

#### Input over-current protection (OCP):

When the total input current exceeds 4.2A, Q2 (Fig 12) is controlled linearly to regulate the current. If the current continues to exceeds 4.2A after a 120 $\mu$ s blanking time, Q2 will be turn off. In the event of input current exceeding 7A Q2 will be turned off almost instantaneously and without any blanking time, this to protect both Q1 and Q2.

#### Input over-voltage protection (OVP):

The MP2637 uses the PWIN pin to sense the status of input voltage. When the voltage at the PWIN pin is lower than 0.8V or higher than 1.15V, an invalid input power source is detected by the MP2637. At this time the IN to SYS pass-through path will be turned off. An OVP threshold can be programmed via PWIN pin to prevent an over

voltage event happening at SYS side when plugging in a wrong adapter.

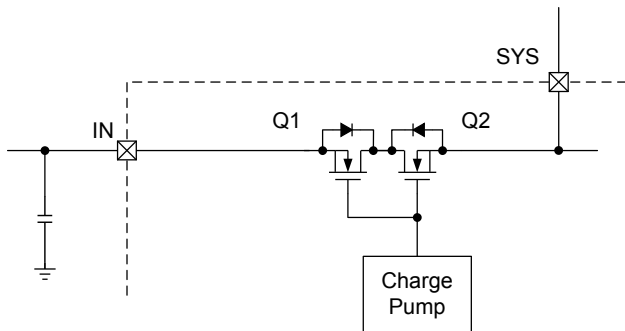

**Figure 12: Integrated Pass-through Path**

**Charge Current Setting**

The external sense resistors, RS1 and R<sub>ISET</sub>, program the battery charge current, I<sub>CHG</sub>. Select R<sub>ISET</sub> based on RS1:

$$I_{CHG} (A) = \frac{2400}{R_{ISET} (k\Omega) \times RS1(m\Omega)} \quad (5)$$

**Battery Short Protection**

The MP2637 has two current limit thresholds. CC and CV modes have a peak current limit threshold of 6.5A, while TC mode has a current limit threshold of 3.2A. Therefore, the current limit threshold decreases to 3.2A when the battery voltage drops below the TC threshold. Moreover, the switching frequency also decreases when the BATT voltage drops to 40% of the charge-full voltage.

**Thermal Foldback Function**

The MP2637 implements thermal protection to prevent thermal damage to the IC and the surrounding components. An internal thermal sense and feedback loop automatically decreases the programmed charge current when the die temperature reaches 120°C. This function is called the charge-current-thermal foldback. Not only this function protects against thermal damage, it can also set the charge current based on requirements rather than worst-case conditions while ensuring safe operation. Furthermore, the part includes thermal shutdown protection where the ceases charging if the

junction temperature rises to 150°C.

**Non-sync Operation Mode**

During charging mode, the MP2637 continuously monitors the total input current flowing from IN pin to SYS pin. When the input current is lower than 170mA, the low side switch operates as a non-synchronous MOSFET.

**Constant-Off-Time Control for Large Duty Charging Operation**

The MP2637 has a built-in 600kHz frequency oscillator for the switching frequency. Unlike a traditional fixed frequency, the MP2637 features a constant off time control to support constant-current charge even when the input voltage is very close to battery voltage. As shown in the Figure 13, the MP2637 continuously compares the high-side FET sense current with comp level, if the sense current doesn't reach the comp level within the original switching period, the next clock will be delayed until the sense current reaches the comp level. As a result the duty cycle is able to be extended as large as possible.

**Full Operation Indication**

The MP2637 integrates indicators for the following conditions as shown in Table 2. The blinking frequency is:

$$F_{Blinking} = \frac{1(\mu A)}{0.8 \times C_{TMR} (\mu F)} \quad (6)$$

**Table 2: Indicator for Each Operation Mode**

Operation		ACOK	CHG	BOOST
Charge Mode	In Charging	Low	Low	High
	End of Charge, Charging disabled, Battery OVP		High	
	NTC Fault, Timer Out		Blinking	
Boost Mode		High	High	Low
Sleep Mode		High	High	High

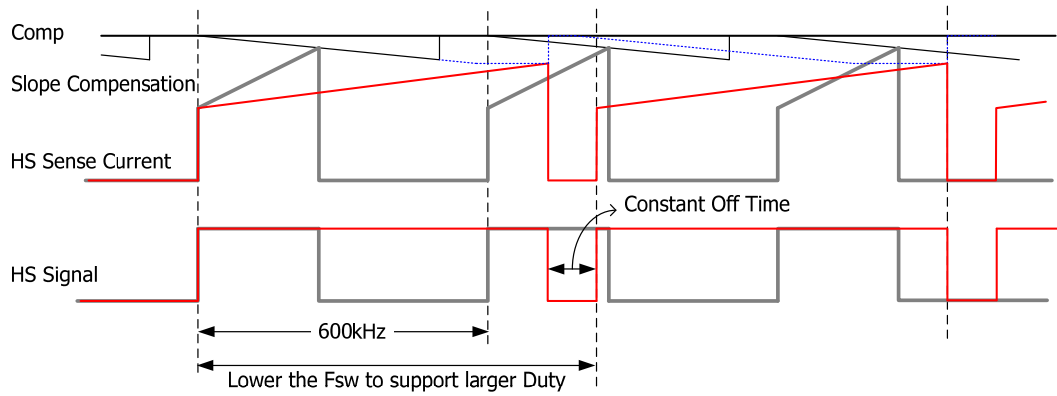

**Figure 13: Constant-Off-Time Operation Profile**

**BOOST MODE OPERATION**

**Low-Voltage Start-Up**

The minimum battery voltage required to start up the circuit in boost mode is 2.9V. Initially, when  $V_{SYS} < V_{BATT}$ , the MP2637 works in down mode. In this mode, the synchronous P-MOSFET stops switching and its gate connects to  $V_{BATT}$  statically. The P-MOSFET stays off as long as the voltage across the parasitic  $C_{DS}$  ( $V_{SW}$ ) is lower than  $V_{BATT}$ . When the voltage across  $C_{DS}$  exceeds  $V_{BATT}$ , the synchronous P-MOSFET enters linear mode allowing the inductor current to decrease and flowing into the SYS pin. Once  $V_{SYS}$  exceeds  $V_{BATT}$ , the P-MOSFET gate is released and normal closed-loop PWM operation is initiated. In boost mode, the battery voltage can drop to as low as 2.5V without affecting circuit operation.

**SYS Disconnect and Inrush Limiting**

The MP2637 allows for true output disconnect by eliminating body diode conduction of the internal P-MOSFET rectifier.  $V_{SYS}$  can go to 0V during shutdown, drawing no current from the input source. It also allows for inrush current limiting at start-up, minimizing surge currents from the input supply. To optimize the benefits of output disconnect, avoid connecting an external Schottky diode between the SW and SYS pins.

Board layout is extremely critical to minimize voltage overshoot at the SW pin due to stray inductance. Keep the output filter capacitor as close as possible to the SYS pin and use very low ESR/ESL ceramic capacitors tied to a good ground plane.

**Boost Output Voltage Setting**

In boost mode, the MP2637 programs the output voltage via the external resistor divider at FB pin, and provides built-in output over-voltage protection (OVP) to protect the device and other components against damage when  $V_{SYS}$  goes beyond 6V. Once the output over voltage occurs, the MP2637 turns off the boost converter. When the voltage on  $V_{SYS}$  drops to a normal level, the

boost converter restarts again as long as the MODE pin remains in active status.

**Boost Output Current Limiting**

The MP2637 integrates a programmable output current limit function in boost mode. If the boost output current exceeds this programmable limit, the output current will be limited at this level and the SYS voltage will start to drop down. The OLIM pin programs the current limit threshold up to 2.4A as per the following equation:

$$I_{OLIM}(A) = \frac{2400}{R_{OLIM}(k\Omega) \times RS1(m\Omega)} \quad (7)$$

**SYS Output Over Current Protection**

The MP2637 integrates three-phase output over-current protection.

**Phase one** (boost mode output current limit): when the output current exceeds the programmed output current limit, the output constant current loop controls the output current, the output current remains at its limit of  $I_{OLIM}$ , and  $V_{SYS}$  decreases.

**Phase two** (down mode): when  $V_{SYS}$  drops below  $V_{BATT}+100mV$  and the output current loop remains in control, the boost converter enters down mode and shutdown after a 120µs blanking time.

**Phase three** (short circuit mode): when  $V_{SYS}$  drops below 3.75V (will be 2V during boost soft start), the boost converter shuts down immediately once the inductor current hits the fold-back peak current limit of the low side N-MOSFET. The boost converter can also recover automatically after a 1ms deglitch period.

**Thermal Shutdown Protection**

The thermal shutdown protection is also active in boost mode. Once the junction temperature rises higher than 150°C, the MP2637 enters thermal shutdown. It will not resume normal operation until the junction temperature drops below 120°C

## APPLICATION INFORMATION

### COMPONENT SELECTION

#### Setting the Charge Current in Charge Mode

In charge mode, both the external sense resistor, RS1, and the resistor R<sub>ISET</sub> connect to the ISET pin to set the charge current (I<sub>CHG</sub>) of the MP2637 (see the Typical Application circuit).

Given I<sub>CHG</sub> and RS1, R<sub>ISET</sub> can be calculated as:

$$R_{ISET} (k\Omega) = \frac{2400}{I_{CHG} (A) \times RS1 (m\Omega)} \quad (8)$$

For example, for I<sub>CHG</sub>=2.5A, and RS1=20mΩ, thus: R<sub>ISET</sub>=48kΩ.

#### Setting the Input Current Limiting in Charge Mode

In charge mode, connect a resistor from the ILIM pin to AGND to program the input current limit. The relationship between the input current limit and setting resistor is as following:

$$R_{ILIM} = \frac{45}{I_{IN\_LIM} (A)} (k\Omega) \quad (9)$$

where R<sub>ILIM</sub> must exceed 16.5kΩ, so that I<sub>IN\_LIM</sub> is in the range of 0A to 2.7A.

For most applications, use R<sub>ILIM</sub> = 50kΩ (I<sub>USB\_LIM</sub>=900mA) for USB3.0 mode, and use R<sub>ILIM</sub> = 90kΩ (I<sub>USB\_LIM</sub>=500mA) for USB2.0 mode.

#### Setting the Input Voltage Range for Different Operation Modes

A resistive voltage divider from the input to PWIN pin determines the operating mode of MP2637.

$$V_{PWIN} = V_{IN} \times \frac{R6}{R4 + R6} (V) \quad (10)$$

If the voltage on PWIN is between 0.8V and 1.15V, the MP2637 works in the charge mode. While the voltage on the PWIN pin is not in the range of 0.8V to 1.15V and V<sub>IN</sub> > 2V, the MP2637 works in the boost mode (see Table 1)).

For a wide operating range, use a maximum input voltage of 6V as the upper threshold for a voltage ratio of:

$$\frac{V_{PWIN}}{V_{IN}} = \frac{1.15}{6} = \frac{R6}{R4 + R6} \quad (11)$$

With the given R6, R4 is then:

$$R4 = \frac{V_{IN} - V_{PWIN}}{V_{PWIN}} \times R6 \quad (12)$$

For a typical application, start with R6=5.1kΩ, R4 is 21.5kΩ.

#### Setting the Input Voltage Regulation in Charge Mode

In charge mode, connect a resistor divider from the IN pin to AGND with tapped to REG pin to program the input voltage regulation.

$$V_{IN\_R} = V_{REG} \times \frac{R3 + R5}{R5} (V) \quad (13)$$

With the given R5, R3 is:

$$R3 = \frac{V_{IN\_R} - V_{REG}}{V_{REG}} \times R5 (V) \quad (14)$$

For a preset input voltage regulation value, say 4.75V, start with R5=5.1kΩ, R3 is 15kΩ.

#### NTC Function in Charge Mode

Figure 14 shows that an internal resistor divider sets the low temperature threshold (V<sub>TL</sub>) and high temperature threshold (V<sub>TH</sub>) at 66.6%·V<sub>SYS</sub> and 35%·V<sub>SYS</sub>, respectively. For a given NTC thermistor, select an appropriate R<sub>T1</sub> and R<sub>T2</sub> to set the NTC window.

$$\frac{V_{TL}}{V_{SYS}} = \frac{R_{T2} // R_{NTC\_Cold}}{R_{T1} + R_{T2} // R_{NTC\_Cold}} = TL = 66.6\% \quad (15)$$

$$\frac{V_{TH}}{V_{SYS}} = \frac{R_{T2} // R_{NTC\_Hot}}{R_{T1} + R_{T2} // R_{NTC\_Hot}} = TH = 35\% \quad (16)$$

Where R<sub>NTC\_Hot</sub> is the value of the NTC resistor at the upper bound of its operating temperature range, and R<sub>NTC\_Cold</sub> is its lower bound.

The two resistors, R<sub>T1</sub> and R<sub>T2</sub>, independently determine the upper and lower temperature limits. This flexibility allows the MP2637 to operate with most NTC resistors for different temperature range requirements. Calculate R<sub>T1</sub> and R<sub>T2</sub> as follows:

$$R_{T1} = \frac{R_{NTC\_Hot} \times R_{NTC\_Cold} \times (TL - TH)}{TH \times TL \times (R_{NTC\_Cold} - R_{NTC\_Hot})} \quad (17)$$

$$R_{T2} = \frac{(TL - TH) \times R_{NTC\_Cold} \times R_{NTC\_Hot}}{(1 - TL) \times TH \times R_{NTC\_Cold} - (1 - TH) \times TL \times R_{NTC\_Hot}} \quad (18)$$

For example, the NCP18XH103 thermistor has the following electrical characteristic:

At 0°C,  $R_{NTC\_Cold} = 27.445k\Omega$ ;

At 50°C,  $R_{NTC\_Hot} = 4.1601k\Omega$ .

Based on equation (17) and equation (18),  $R_{T1}=6.65k\Omega$  and  $R_{T2} = 25.63k\Omega$  are suitable for an NTC window between 0°C and 50°C. Chose approximate values: e.g.,  $R_{T1}=6.65k\Omega$  and  $R_{T2}=25.5k\Omega$ .

If no external NTC is available, connect  $R_{T1}$  and  $R_{T2}$  to keep the voltage on the NTC pin within the valid NTC window: e.g.,  $R_{T1} = R_{T2} = 10k\Omega$ .

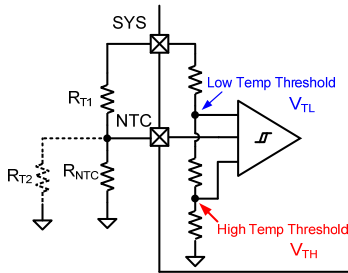

**Figure 14: NTC Function Block**

For convenience, an NTC thermistor design spreadsheet is also provided, please inquire if necessary.

### Setting the System Voltage in Boost Mode

In the boost mode, the system voltage can be regulated to the value customer required between 4.2V to 6V by the resistor divider at FB pin as R1 and R2 in the typical application circuit.

$$V_{SYS} = 1.2V \times \frac{R1 + R2}{R2} \quad (19)$$

where 1.2V is the voltage reference of SYS. With a typical value for R2, 10kΩ, R1 can be determined by:

$$R1 = R2 \times \frac{V_{SYS} - 1.2V}{1.2V} (V) \quad (20)$$

For example, for a 5V system voltage, R2 is 10kΩ, and R1 is 31.6kΩ.

### Setting the Output Current Limit in Boost Mode

In boost mode, connect a resistor from the OLIM pin to AGND to program the output current limit. The relationship between the output current limit and setting resistor is as follows:

$$I_{OLIM}(A) = \frac{2400}{R_{OLIM}(k\Omega) \times RS1(m\Omega)} \quad (21)$$

The output current limit of the boost can be programmed up to 2.1A (min). Considering 10% output current limit accuracy, typical 2.3A output current limit is required. According to the above equation, given 20mΩ sense resistor, 52k  $R_{OLIM}$  will get 2.3A output current limit.

For safety operation,  $R_{OLIM}$  **CANNOT** be lower than 47.5kΩ

### Selecting the Inductor

Inductor selection trades off between cost, size, and efficiency. A lower inductance value corresponds with smaller size, but results in higher current ripple, higher magnetic hysteretic losses, and higher output capacitances. However, a higher inductance value benefits from lower ripple current and smaller output filter capacitors, but results in higher inductor DC resistance (DCR) loss.

Choose an inductor that does not saturate under the worst-case load condition.

#### 1. In Charge Mode

When MP2637 works in charge mode (as a Buck Converter), estimate the required inductance as:

$$L = \frac{V_{IN} - V_{BATT}}{\Delta I_{L\_MAX}} \times \frac{V_{BATT}}{V_{IN} \times f_{SW}} \quad (22)$$

where  $V_{IN}$ ,  $V_{BATT}$ , and  $f_s$  are the typical input voltage, the CC charge threshold, and the switching frequency, respectively.  $\Delta I_{L\_MAX}$  is the maximum peak-to-peak inductor current, which is usually designed at 30%-40% of the CC charge current.

With a typical 5V input voltage, 35% inductor current ripple at the corner point between trickle charge and CC charge ( $V_{BATT}=3V$ ,  $I_{chg}=2.5A$ ), the inductance 2.2μH.

#### 2. In Boost Mode



When the MP2637 is in Boost mode (as a Boost converter), the required inductance value is calculated as:

$$L = \frac{V_{BATT} \times (V_{SYS} - V_{BATT})}{V_{SYS} \times f_{SW} \times \Delta I_{L\_MAX}} \quad (23)$$

$$\Delta I_{L\_MAX} = (30\% - 40\%) \times I_{BATT(MAX)} \quad (24)$$

$$I_{BATT(MAX)} = \frac{V_{SYS} \times I_{SYS}}{V_{BATT} \times \eta} \quad (25)$$

Where  $V_{BATT}$  is the minimum battery voltage,  $f_{SW}$  is the switching frequency, and  $\Delta I_{L\_MAX}$  is the peak-to-peak inductor ripple current, which is approximately 30% of the maximum battery current  $I_{BATT(MAX)}$ ,  $I_{SYS(MAX)}$  is the system current and  $\eta$  is the efficiency.

In the worst case where the battery voltage is 3V, a 30% inductor current ripple, and a typical system voltage ( $V_{SYS}=5V$ ), the inductance is 1.5 $\mu$ H when the efficiency is 90%.

For best results, use an inductor with an inductance of 2.2 $\mu$ H with a DC current rating that is not lower than the peak current of MOSFET. For higher efficiency, minimize the inductor's DC resistance.

### Selecting the Input Capacitor $C_{IN}$

The input capacitor  $C_{IN}$  reduces both the surge current drawn from the input and the switching noise from the device. The input capacitor impedance at the switching frequency should be less than the input source impedance to prevent high-frequency-switching current from passing to the input. For best results, use ceramic capacitors with X7R dielectrics because of their low ESR and small temperature coefficients. For most applications, a 22 $\mu$ F capacitor will suffice.

### Selecting the System Capacitor $C_{SYS}$

Select  $C_{SYS}$  based on the demand of the system current ripple.

#### 1. Charge Mode

The capacitor  $C_{SYS}$  acts as the input capacitor of the buck converter in charge mode. The input current ripple is:

$$I_{RMS\_MAX} = I_{SYS\_MAX} \times \frac{\sqrt{V_{TC} \times (V_{IN\_MAX} - V_{TC})}}{V_{IN\_MAX}} \quad (26)$$

#### 2. Boost Mode

The capacitor,  $C_{SYS}$ , is the output capacitor of boost converter.  $C_{SYS}$  keeps the system voltage ripple small and ensures feedback loop stability. The system current ripple is given by:

$$I_{RMS\_MAX} = I_{SYS\_MAX} \times \frac{\sqrt{V_{TC} \times (V_{SYS\_MAX} - V_{TC})}}{V_{SYS\_MAX}} \quad (27)$$

Since the input voltage is passes to the system directly,  $V_{IN\_MAX}=V_{SYS\_MAX}$ , both charge mode and boost mode have the same system current ripple.

For  $I_{CC\_MAX}=2A$ ,  $V_{TC}=3V$ ,  $V_{IN\_MAX}=6V$ , the maximum ripple current is 1.25A. Select the system capacitors base on the ripple-current temperature rise not exceeding 10°C. For best results, use ceramic capacitors with X7R dielectrics with low ESR and small temperature coefficients. For most applications, use three 22 $\mu$ F capacitors.

### Selecting the Battery Capacitor $C_{BATT}$

$C_{BATT}$  is in parallel with the battery to absorb the high-frequency switching ripple current.

#### 1. Charge Mode

The capacitor  $C_{BATT}$  is the output capacitor of the buck converter. The output voltage ripple is then:

$$\Delta r_{BATT} = \frac{\Delta V_{BATT}}{V_{BATT}} = \frac{1 - V_{BATT} / V_{SYS}}{8 \times C_{BATT} \times f_{SW}^2 \times L} \quad (28)$$

#### 2. Boost Mode

The capacitor  $C_{BATT}$  is the input capacitor of the boost converter. The input voltage ripple is the same as the output voltage ripple from equation (28)

Both charge mode and boost mode have the same battery voltage ripple. The capacitor  $C_{BATT}$  can be calculated as:

$$C_{BATT} = \frac{1 - V_{TC} / V_{SYS\_MAX}}{8 \times \Delta r_{BATT\_MAX} \times f_{SW}^2 \times L} \quad (29)$$

To guarantee the  $\pm 0.5\%$  BATT voltage accuracy, the maximum BATT voltage ripple must not exceed 0.5% (e.g. 0.2%). The worst case occurs at the minimum battery voltage of the CC charge with the maximum input voltage.

For  $V_{SYS\_MAX}=6V$ ,  $V_{CC\_MIN}=V_{TC}=3V$ ,  $L=2.2\mu H$ ,  $f_{SW}=600kHz$ ,  $\Delta r_{BATT\_MAX} = 0.2\%$ ,  $C_{BATT}$  is  $39\mu F$ .

Two pieces of  $22\mu F$  ceramic with X7R dielectrics capacitor in parallel will suffice.

**PCB Layout Guide**

PCB layout is very important to meet specified noise, efficiency and stability requirements. The following design considerations can improve circuit performance:

1) Route the power stage adjacent to their grounds. Aim to minimize the high-side switching node (SW, inductor) trace lengths in the high-current paths.

Keep the switching node short and away from all small control signals, especially the feedback network.

Place the input capacitor as close as possible to the VIN and PGND pins. The local power input capacitors, connected from the SYS to PGND, must be placed as close as possible to the IC.

Place the output inductor close to the IC and connect the output capacitor between the inductor and PGND of the IC.

2) For high-current applications, the power pads for IN, SYS, SW, BATT and PGND should be connected to as many coppers planes on the board as possible. This improves thermal performance because the board conducts heat away from the IC.

3) The PCB should have a ground plane connected directly to the return of all components through vias (e.g., two vias per capacitor for power-stage capacitors, one via per capacitor for small-signal components). A star ground design approach is typically used to keep circuit block currents isolated (power-signal/control-signal), which reduces noise-coupling and ground-bounce issues. A single ground plane for this design gives good results.

4) Place ISET, OLIM and ILIM resistors very close to their respective IC pins.

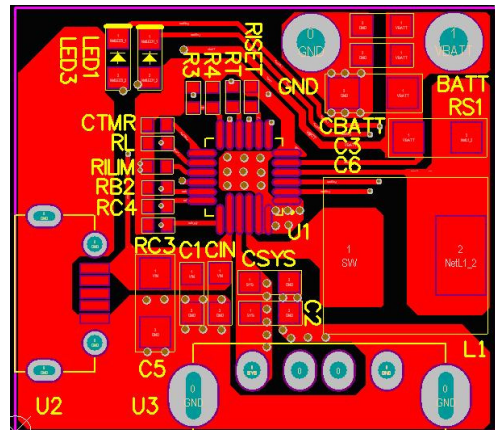

**TYPICAL APPLICATION CIRCUITS**

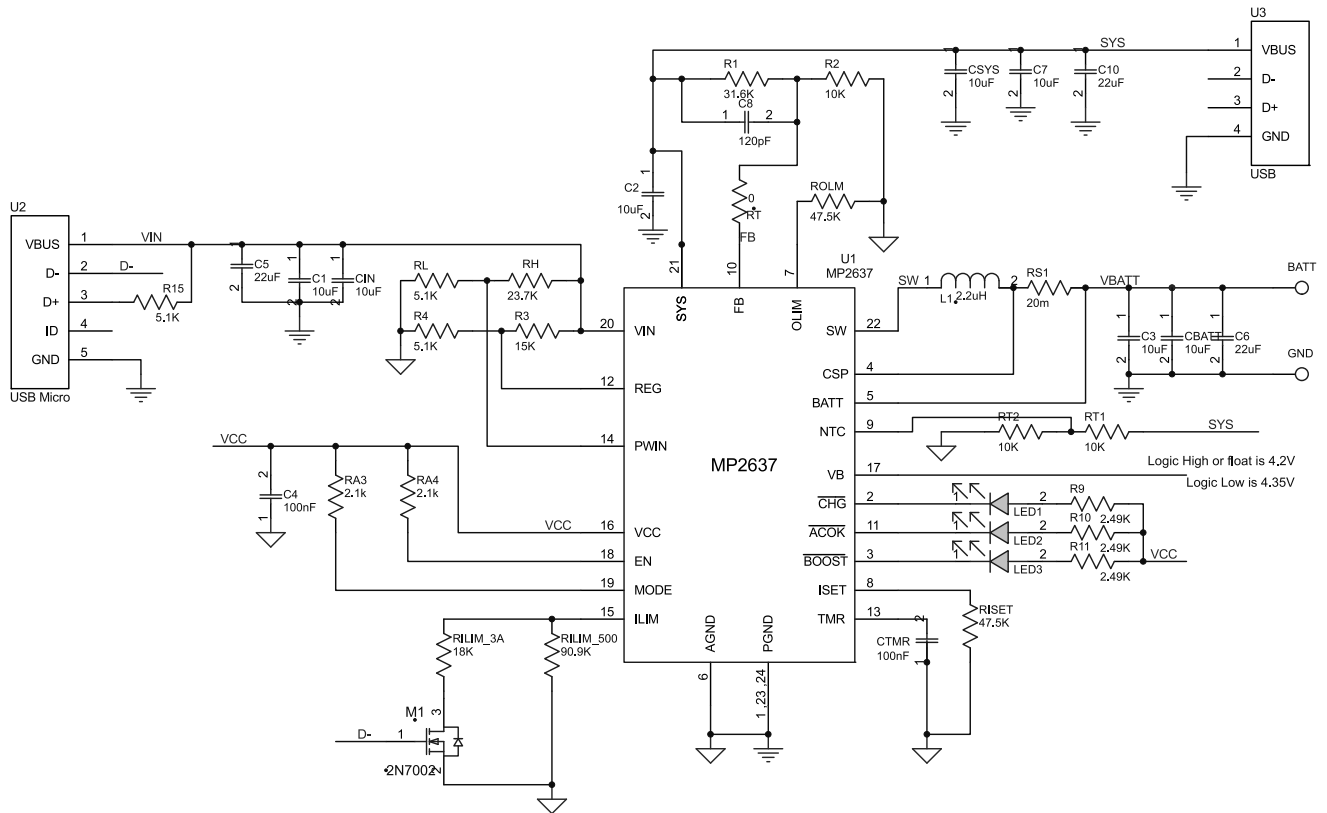

**Figure 16: Typical Application Circuit of MP2637 with USB connectors**

**PACKAGE INFORMATION**

**QFN-24 (4mmx4mm)**

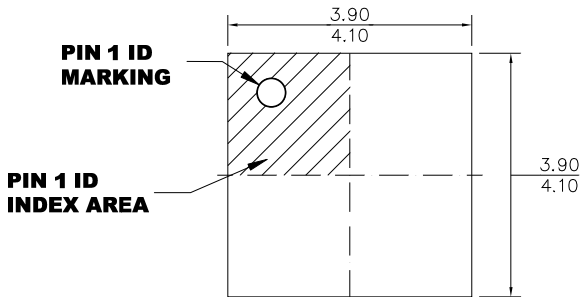

**TOP VIEW**

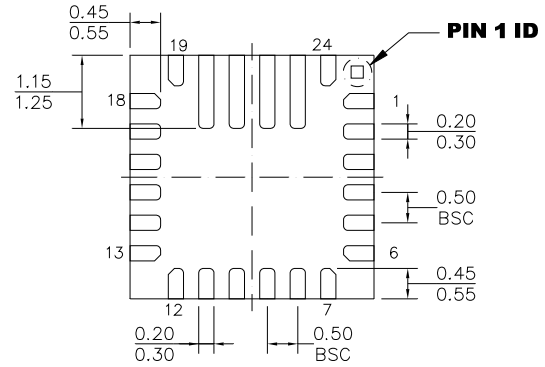

**BOTTOM VIEW**

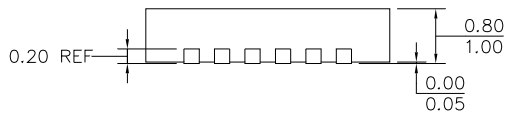

**SIDE VIEW**

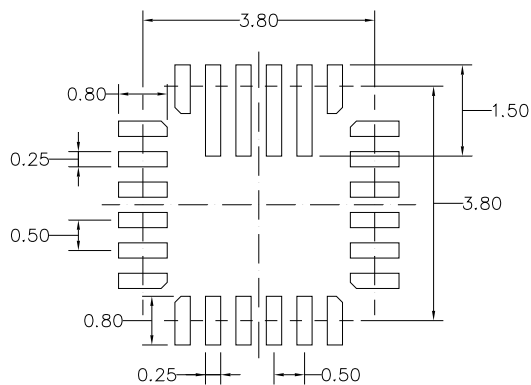

**RECOMMENDED LAND PATTERN**

**NOTE:**

- 1) ALL DIMENSIONS ARE IN MILLIMETERS.
- 2) EXPOSED PADDLE SIZE DOES NOT INCLUDE MOLD FLASH.
- 3) LEAD COPLANARITY SHALL BE 0.10 MILLIMETERS MAX.
- 4) JEDEC REFERENCE IS MO-220.
- 5) DRAWING IS NOT TO SCALE.

### Revision History

Revision #	Revision Date	Description	Pages Updated
1.0	7/2/2014	Initial Release	-
1.05	11/6/2020	Add a description to the feature list: IEC 62368-1 AK Certification	Page 1

**NOTICE:** The information in this document is subject to change without notice. Users should warrant and guarantee that third party Intellectual Property rights are not infringed upon when integrating MPS products into any application. MPS will not assume any legal responsibility for any said applications.