

NTMFS4C024N

MOSFET – Power, Single, N-Channel, SO-8 FL 30 V, 78 A

Features

- Low $R_{DS(on)}$ to Minimize Conduction Losses
- Low Capacitance to Minimize Driver Losses
- Optimized Gate Charge to Minimize Switching Losses
- These Devices are Pb-Free, Halogen Free/BFR Free and are RoHS Compliant

Applications

- CPU Power Delivery
- DC-DC Converters

MAXIMUM RATINGS ($T_J = 25^\circ\text{C}$ unless otherwise stated)

Parameter	Symbol	Value	Unit
Drain-to-Source Voltage	V_{DS}	30	V
Gate-to-Source Voltage	V_{GS}	± 20	V
Continuous Drain Current $R_{\theta JA}$ (Note 1)	I_D	$T_A = 25^\circ\text{C}$	21.7
		$T_A = 80^\circ\text{C}$	16.3
Power Dissipation $R_{\theta JA}$ (Note 1)	P_D	2.57	W
Continuous Drain Current $R_{\theta JA} \leq 10$ s (Note 1)	I_D	$T_A = 25^\circ\text{C}$	34.8
		$T_A = 80^\circ\text{C}$	26.0
Power Dissipation $R_{\theta JA} \leq 10$ s (Note 1)	P_D	6.6	W
Continuous Drain Current $R_{\theta JA}$ (Note 2)	I_D	$T_A = 25^\circ\text{C}$	11.9
		$T_A = 80^\circ\text{C}$	8.9
Power Dissipation $R_{\theta JA}$ (Note 2)	P_D	0.77	W
Continuous Drain Current $R_{\theta JC}$ (Note 1)	I_D	$T_C = 25^\circ\text{C}$	78
		$T_C = 80^\circ\text{C}$	58
Power Dissipation $R_{\theta JC}$ (Note 1)	P_D	33	W
Pulsed Drain Current	$T_A = 25^\circ\text{C}, t_p = 10 \mu\text{s}$	I_{DM}	174
Current Limited by Package	$T_A = 25^\circ\text{C}$	I_{Dmax}	80
Operating Junction and Storage Temperature	T_J, T_{STG}	-55 to +150	$^\circ\text{C}$
Source Current (Body Diode)	I_S	30	A
Drain to Source dV/dt	dV/dt	7.0	V/ns
Single Pulse Drain-to-Source Avalanche Energy ($T_J = 25^\circ\text{C}, V_{GS} = 20$ V, $I_L = 41$ A _{pk} , $L = 0.1$ mH, $R_{GS} = 25 \Omega$) (Note 3)	E_{AS}	84	mJ
Lead Temperature for Soldering Purposes (1/8" from case for 10 s)	T_L	260	$^\circ\text{C}$

Stresses exceeding those listed in the Maximum Ratings table may damage the device. If any of these limits are exceeded, device functionality should not be assumed, damage may occur and reliability may be affected.

1. Surface-mounted on FR4 board using 1 sq-in pad, 1 oz Cu.
2. Surface-mounted on FR4 board using the minimum recommended pad size.



ON Semiconductor®

www.onsemi.com

$V_{(BR)DSS}$	$R_{DS(ON)}$ MAX	I_D MAX
30 V	2.8 m Ω @ 10 V	78 A
	4.0 m Ω @ 4.5 V	

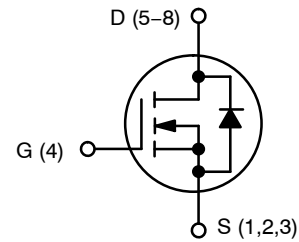

N-CHANNEL MOSFET

MARKING DIAGRAMS

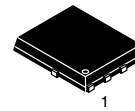

SO-8 FLAT LEAD CASE 488AA STYLE 1

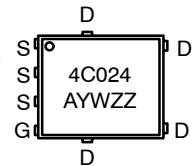

- A = Assembly Location
- Y = Year
- W = Work Week
- ZZ = Lot Traceability

ORDERING INFORMATION

Device	Package	Shipping†
NTMFS4C024NT1G	SO-8 FL (Pb-Free)	1500 / Tape & Reel
NTMFS4C024NT3G	SO-8 FL (Pb-Free)	5000 / Tape & Reel

†For information on tape and reel specifications, including part orientation and tape sizes, please refer to our Tape and Reel Packaging Specifications Brochure, BRD8011/D.

NTMFS4C024N

3. This is the absolute maximum ratings. Parts are 100% tested at $T_J = 25^\circ\text{C}$,
 $V_{GS} = 20\text{ V}$, $I_L = 29\text{ A}$, $E_{AS} = 42\text{ mJ}$.

THEMAL RESISTANCE MAXIMUM RATINGS

Parameter	Symbol	Value	Unit
Junction-to-Case (Drain)	$R_{\theta JC}$	3.8	°C/W
Junction-to-Ambient – Steady State (Note 4)	$R_{\theta JA}$	48.6	
Junction-to-Ambient – Steady State (Note 5)	$R_{\theta JA}$	161.7	
Junction-to-Ambient – ($t \leq 10\text{ s}$) (Note 4)	$R_{\theta JA}$	19	

4. Surface-mounted on FR4 board using 1 sq-in pad, 1 oz Cu.
 5. Surface-mounted on FR4 board using the minimum recommended pad size.

ELECTRICAL CHARACTERISTICS ($T_J = 25^\circ\text{C}$ unless otherwise specified)

Parameter	Symbol	Test Condition	Min	Typ	Max	Unit
-----------	--------	----------------	-----	-----	-----	------

OFF CHARACTERISTICS

Drain-to-Source Breakdown Voltage	$V_{(BR)DSS}$	$V_{GS} = 0\text{ V}$, $I_D = 250\ \mu\text{A}$	30			V
Drain-to-Source Breakdown Voltage (transient)	$V_{(BR)DSSst}$	$V_{GS} = 0\text{ V}$, $I_{D(aval)} = 12.6\text{ A}$, $T_{case} = 25^\circ\text{C}$, $t_{transient} = 100\text{ ns}$	34			V
Drain-to-Source Breakdown Voltage Temperature Coefficient	$V_{(BR)DSS}/T_J$			12		mV/°C
Zero Gate Voltage Drain Current	I_{DSS}	$V_{GS} = 0\text{ V}$, $V_{DS} = 24\text{ V}$			1.0	μA
		$T_J = 25^\circ\text{C}$			10	
Gate-to-Source Leakage Current	I_{GSS}	$V_{DS} = 0\text{ V}$, $V_{GS} = \pm 20\text{ V}$			± 100	nA

ON CHARACTERISTICS (Note 6)

Gate Threshold Voltage	$V_{GS(TH)}$	$V_{GS} = V_{DS}$, $I_D = 250\ \mu\text{A}$	1.3		2.2	V
Negative Threshold Temperature Coefficient	$V_{GS(TH)}/T_J$			5.1		mV/°C
Drain-to-Source On Resistance	$R_{DS(on)}$	$V_{GS} = 10\text{ V}$, $I_D = 30\text{ A}$ $V_{GS} = 4.5\text{ V}$, $I_D = 30\text{ A}$		2.3	2.8	m Ω
				3.3	4.0	
Forward Transconductance	g_{FS}	$V_{DS} = 1.5\text{ V}$, $I_D = 15\text{ A}$		68		S
Gate Resistance	R_G	$T_A = 25^\circ\text{C}$	0.3	1.0	2.0	Ω

CHARGES AND CAPACITANCES

Input Capacitance	C_{ISS}	$V_{GS} = 0\text{ V}$, $f = 1\text{ MHz}$, $V_{DS} = 15\text{ V}$		1972		pF
Output Capacitance	C_{OSS}			1215		
Reverse Transfer Capacitance	C_{RSS}			59		
Capacitance Ratio	C_{RSS}/C_{ISS}	$V_{GS} = 0\text{ V}$, $V_{DS} = 15\text{ V}$, $f = 1\text{ MHz}$		0.030		
Total Gate Charge	$Q_{G(TOT)}$	$V_{GS} = 4.5\text{ V}$, $V_{DS} = 15\text{ V}$; $I_D = 30\text{ A}$		14		nC
Threshold Gate Charge	$Q_{G(TH)}$			3.3		
Gate-to-Source Charge	Q_{GS}			6.0		
Gate-to-Drain Charge	Q_{GD}			5.0		
Gate Plateau Voltage	V_{GP}			3.1		V
Total Gate Charge	$Q_{G(TOT)}$	$V_{GS} = 10\text{ V}$, $V_{DS} = 15\text{ V}$; $I_D = 30\text{ A}$		30		nC

SWITCHING CHARACTERISTICS (Note 7)

Turn-On Delay Time	$t_{d(ON)}$	$V_{GS} = 4.5\text{ V}$, $V_{DS} = 15\text{ V}$, $I_D = 15\text{ A}$, $R_G = 3.0\ \Omega$		11		ns
Rise Time	t_r			32		
Turn-Off Delay Time	$t_{d(OFF)}$			21		
Fall Time	t_f			7.0		

NTMFS4C024N

ELECTRICAL CHARACTERISTICS ($T_J = 25^\circ\text{C}$ unless otherwise specified)

Parameter	Symbol	Test Condition	Min	Typ	Max	Unit
SWITCHING CHARACTERISTICS (Note 7)						
Turn-On Delay Time	$t_{d(ON)}$	$V_{GS} = 10\text{ V}, V_{DS} = 15\text{ V},$ $I_D = 15\text{ A}, R_G = 3.0\ \Omega$		8.0		ns
Rise Time	t_r			26		
Turn-Off Delay Time	$t_{d(OFF)}$			26		
Fall Time	t_f			5.0		

DRAIN-SOURCE DIODE CHARACTERISTICS

Forward Diode Voltage	V_{SD}	$V_{GS} = 0\text{ V},$ $I_S = 10\text{ A}$	$T_J = 25^\circ\text{C}$		0.77	1.1	V
			$T_J = 125^\circ\text{C}$		0.62		
Reverse Recovery Time	t_{RR}	$V_{GS} = 0\text{ V}, dI_S/dt = 100\text{ A}/\mu\text{s},$ $I_S = 30\text{ A}$			40.2		ns
Charge Time	t_a				20.3		
Discharge Time	t_b				19.9		
Reverse Recovery Charge	Q_{RR}					30.2	

Product parametric performance is indicated in the Electrical Characteristics for the listed test conditions, unless otherwise noted. Product performance may not be indicated by the Electrical Characteristics if operated under different conditions.

6. Pulse Test: pulse width $\leq 300\ \mu\text{s}$, duty cycle $\leq 2\%$.

7. Switching characteristics are independent of operating junction temperatures.

NTMFS4C024N

TYPICAL CHARACTERISTICS

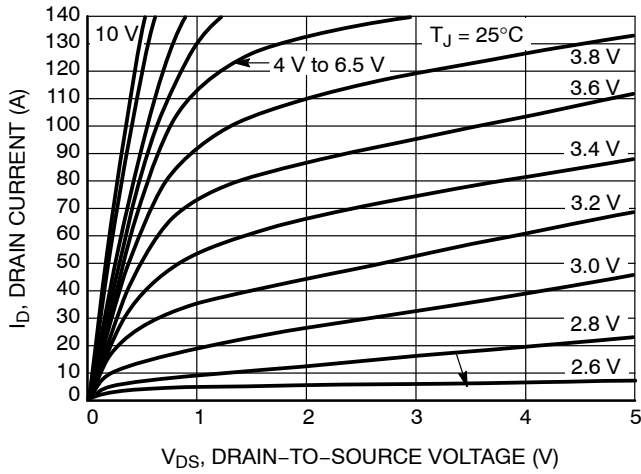

Figure 1. On-Region Characteristics

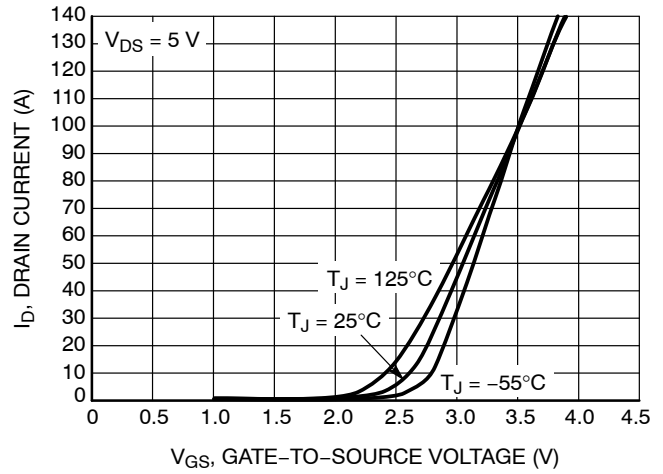

Figure 2. Transfer Characteristics

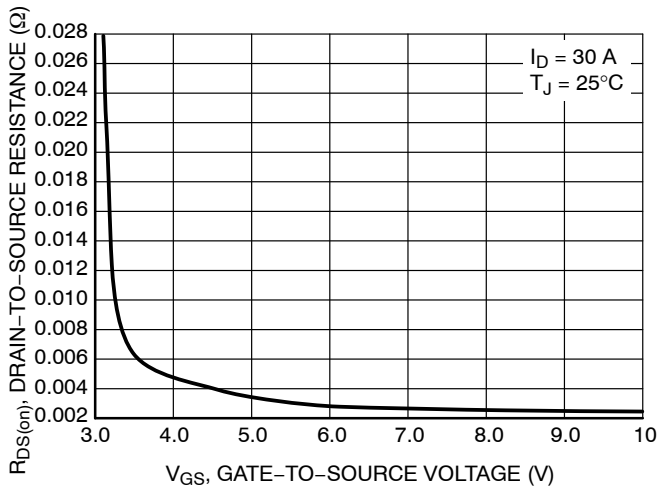

Figure 3. On-Resistance vs. V_{GS}

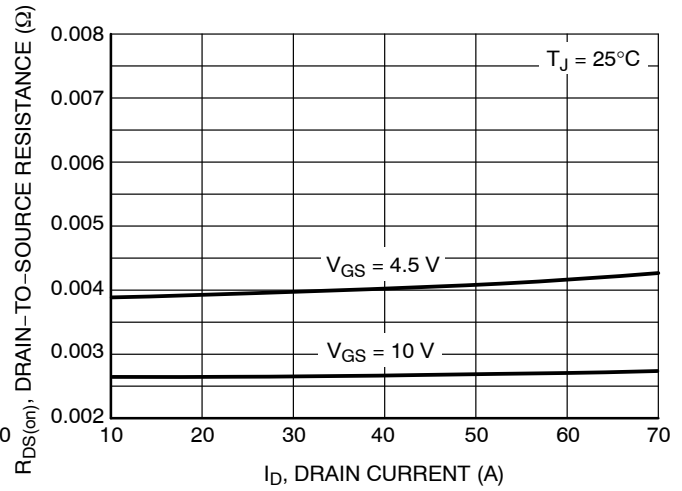

Figure 4. On-Resistance vs. Drain Current and Gate Voltage

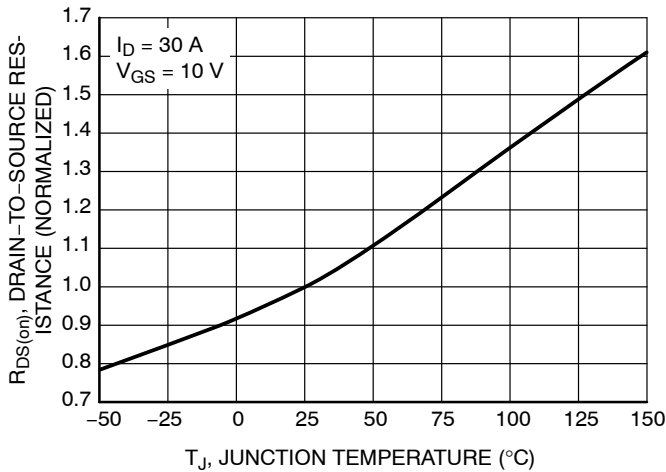

Figure 5. On-Resistance Variation with Temperature

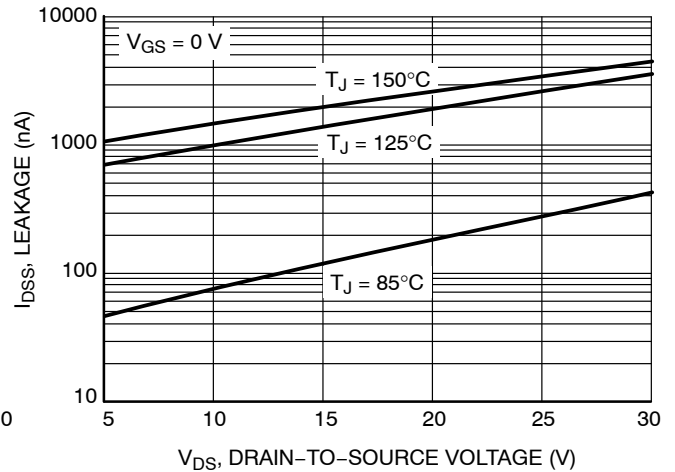

Figure 6. Drain-to-Source Leakage Current vs. Voltage

NTMFS4C024N

TYPICAL CHARACTERISTICS

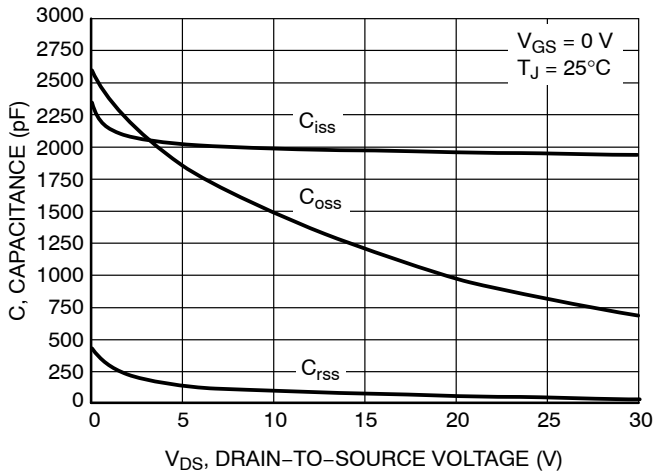

Figure 7. Capacitance Variation

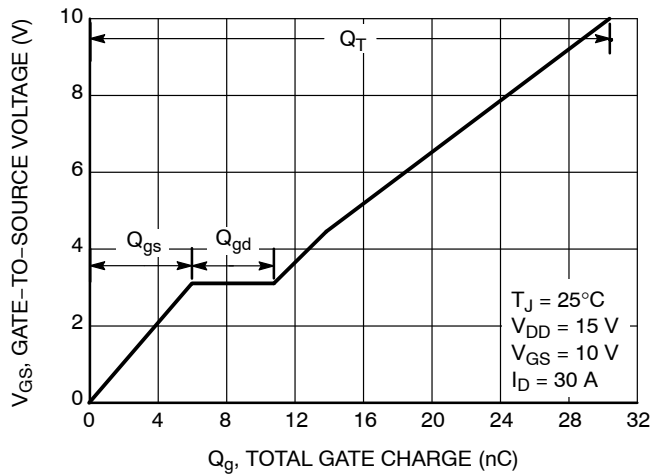

Figure 8. Gate-to-Source and Drain-to-Source Voltage vs. Total Charge



Figure 9. Resistive Switching Time Variation vs. Gate Resistance

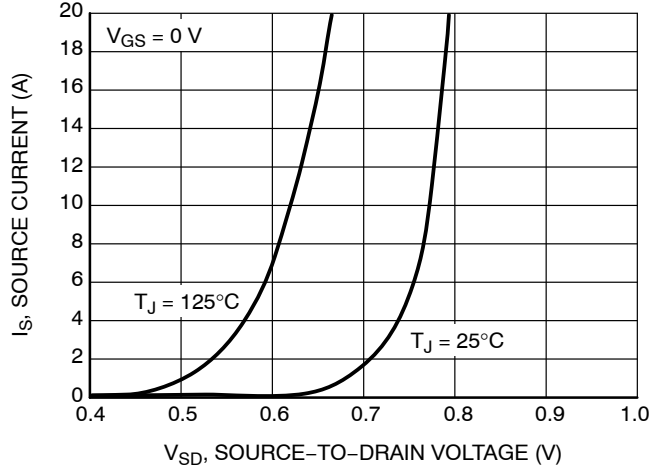

Figure 10. Diode Forward Voltage vs. Current

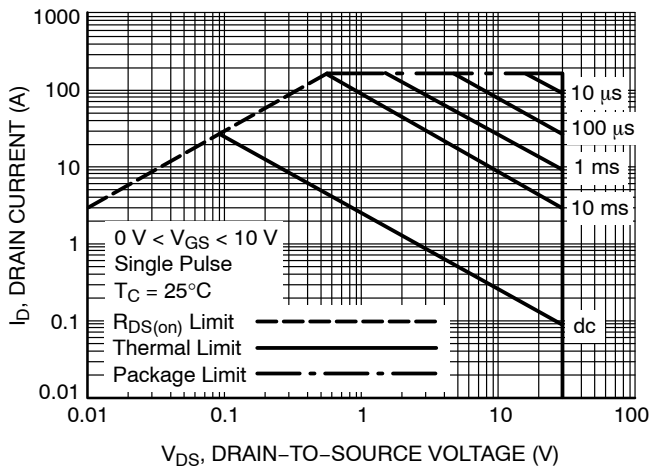

Figure 11. Maximum Rated Forward Biased Safe Operating Area

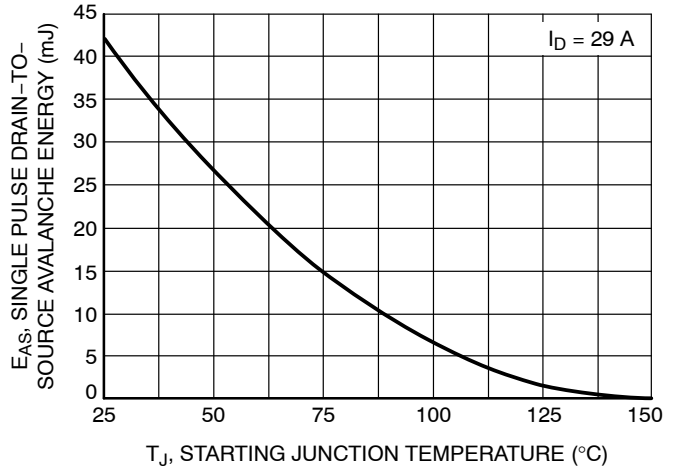

Figure 12. Maximum Avalanche Energy vs. Starting Junction Temperature

NTMFS4C024N

TYPICAL CHARACTERISTICS

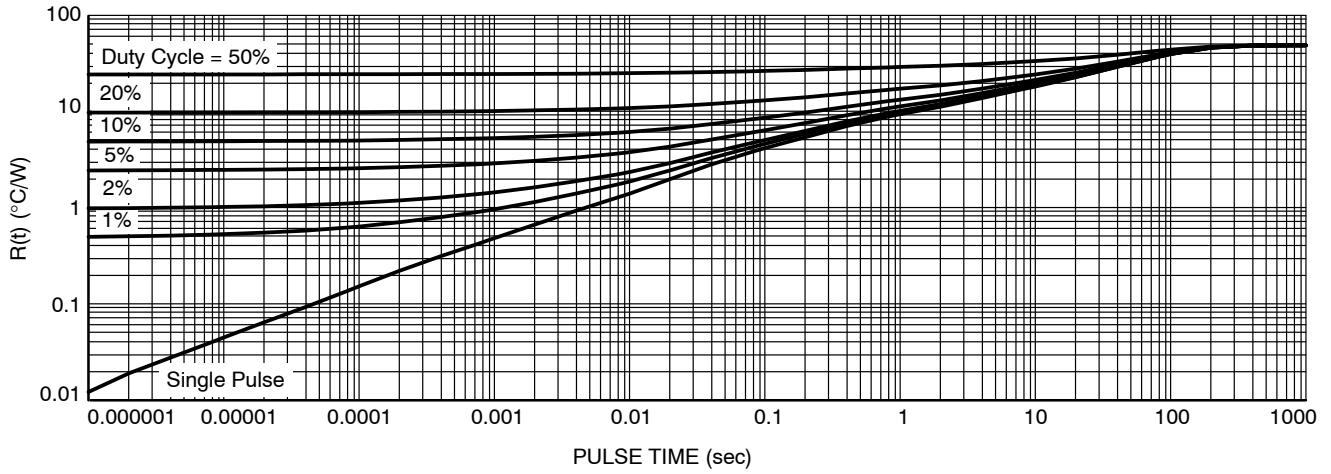

Figure 13. Thermal Response

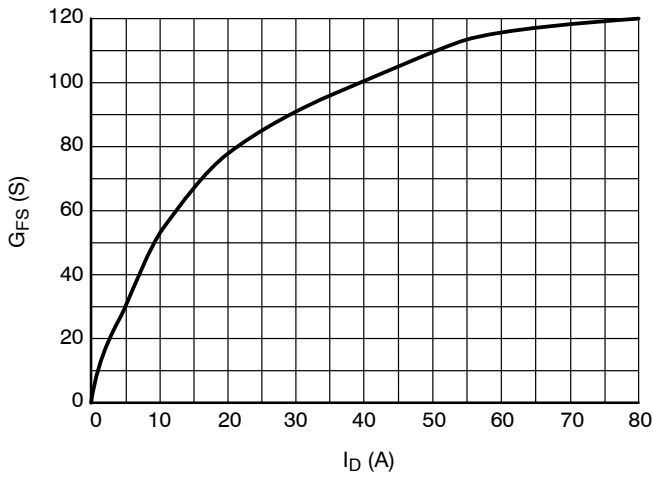

Figure 14. G_{FS} vs. I_D

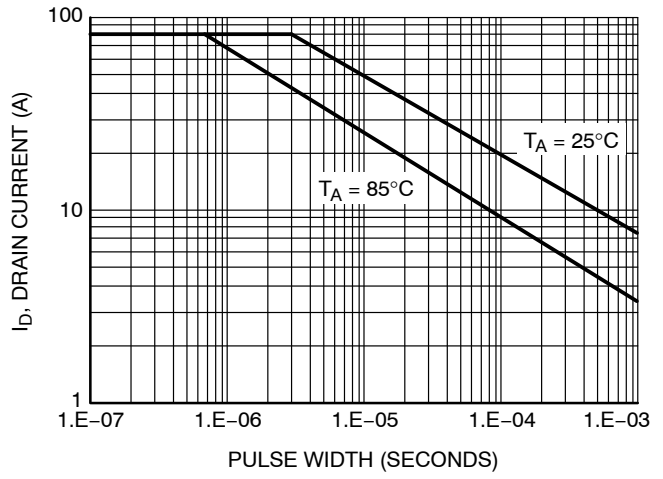
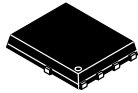

Figure 15. Avalanche Characteristics

MECHANICAL CASE OUTLINE

PACKAGE DIMENSIONS



1
SCALE 2:1

DFN5 5x6, 1.27P
(SO-8FL)
CASE 488AA
ISSUE N

DATE 25 JUN 2018



NOTES:

1. DIMENSIONING AND TOLERANCING PER ASME Y14.5M, 1994.
2. CONTROLLING DIMENSION: MILLIMETER.
3. DIMENSION D1 AND E1 DO NOT INCLUDE MOLD FLASH PROTRUSIONS OR GATE BURRS.

DIM	MILLIMETERS		
	MIN	NOM	MAX
A	0.90	1.00	1.10
A1	0.00	---	0.05
b	0.33	0.41	0.51
c	0.23	0.28	0.33
D	5.00	5.15	5.30
D1	4.70	4.90	5.10
D2	3.80	4.00	4.20
E	6.00	6.15	6.30
E1	5.70	5.90	6.10
E2	3.45	3.65	3.85
e	1.27 BSC		
G	0.51	0.575	0.71
K	1.20	1.35	1.50
L	0.51	0.575	0.71
L1	0.125 REF		
M	3.00	3.40	3.80
θ	0°	---	12°

GENERIC MARKING DIAGRAM*



- XXXXXX = Specific Device Code
- A = Assembly Location
- Y = Year
- W = Work Week
- ZZ = Lot Traceability

*This information is generic. Please refer to device data sheet for actual part marking. Pb-Free indicator, "G" or microdot "•", may or may not be present. Some products may not follow the Generic Marking.

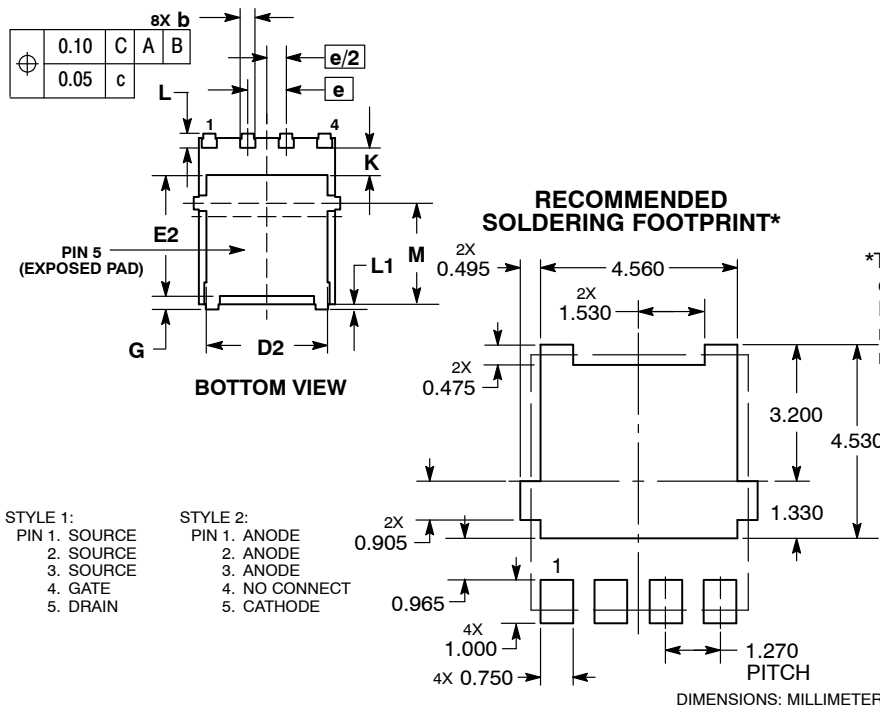

STYLE 1:

- PIN 1. SOURCE
- 2. SOURCE
- 3. SOURCE
- 4. GATE
- 5. DRAIN

STYLE 2:

- PIN 1. ANODE
- 2. ANODE
- 3. ANODE
- 4. NO CONNECT
- 5. CATHODE

DIMENSIONS: MILLIMETERS

*For additional information on our Pb-Free strategy and soldering details, please download the ON Semiconductor Soldering and Mounting Techniques Reference Manual, SOLDERRM/D.

DOCUMENT NUMBER:	98AON14036D	Electronic versions are uncontrolled except when accessed directly from the Document Repository. Printed versions are uncontrolled except when stamped "CONTROLLED COPY" in red.
DESCRIPTION:	DFN5 5x6, 1.27P (SO-8FL)	PAGE 1 OF 1

onsemi and ONSEMI are trademarks of Semiconductor Components Industries, LLC dba onsemi or its subsidiaries in the United States and/or other countries. onsemi reserves the right to make changes without further notice to any products herein. onsemi makes no warranty, representation or guarantee regarding the suitability of its products for any particular purpose, nor does onsemi assume any liability arising out of the application or use of any product or circuit, and specifically disclaims any and all liability, including without limitation special, consequential or incidental damages. onsemi does not convey any license under its patent rights nor the rights of others.

onsemi, **Onsemi**, and other names, marks, and brands are registered and/or common law trademarks of Semiconductor Components Industries, LLC dba "**onsemi**" or its affiliates and/or subsidiaries in the United States and/or other countries. **onsemi** owns the rights to a number of patents, trademarks, copyrights, trade secrets, and other intellectual property. A listing of **onsemi**'s product/patent coverage may be accessed at www.onsemi.com/site/pdf/Patent-Marking.pdf. **onsemi** reserves the right to make changes at any time to any products or information herein, without notice. The information herein is provided "as-is" and **onsemi** makes no warranty, representation or guarantee regarding the accuracy of the information, product features, availability, functionality, or suitability of its products for any particular purpose, nor does **onsemi** assume any liability arising out of the application or use of any product or circuit, and specifically disclaims any and all liability, including without limitation special, consequential or incidental damages. Buyer is responsible for its products and applications using **onsemi** products, including compliance with all laws, regulations and safety requirements or standards, regardless of any support or applications information provided by **onsemi**. "Typical" parameters which may be provided in **onsemi** data sheets and/or specifications can and do vary in different applications and actual performance may vary over time. All operating parameters, including "Typicals" must be validated for each customer application by customer's technical experts. **onsemi** does not convey any license under any of its intellectual property rights nor the rights of others. **onsemi** products are not designed, intended, or authorized for use as a critical component in life support systems or any FDA Class 3 medical devices or medical devices with a same or similar classification in a foreign jurisdiction or any devices intended for implantation in the human body. Should Buyer purchase or use **onsemi** products for any such unintended or unauthorized application, Buyer shall indemnify and hold **onsemi** and its officers, employees, subsidiaries, affiliates, and distributors harmless against all claims, costs, damages, and expenses, and reasonable attorney fees arising out of, directly or indirectly, any claim of personal injury or death associated with such unintended or unauthorized use, even if such claim alleges that **onsemi** was negligent regarding the design or manufacture of the part. **onsemi** is an Equal Opportunity/Affirmative Action Employer. This literature is subject to all applicable copyright laws and is not for resale in any manner.

PUBLICATION ORDERING INFORMATION

LITERATURE FULFILLMENT:

Email Requests to: orderlit@onsemi.com

onsemi Website: www.onsemi.com

TECHNICAL SUPPORT

North American Technical Support:

Voice Mail: 1 800-282-9855 Toll Free USA/Canada

Phone: 011 421 33 790 2910

Europe, Middle East and Africa Technical Support:

Phone: 00421 33 790 2910

For additional information, please contact your local Sales Representative