

ISO VIEW
SCALE 1:1

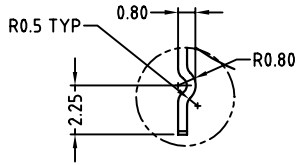

DETAIL A
SCALE 4:1

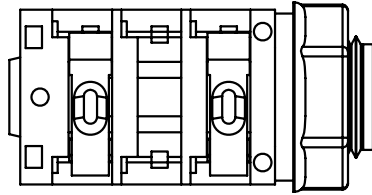
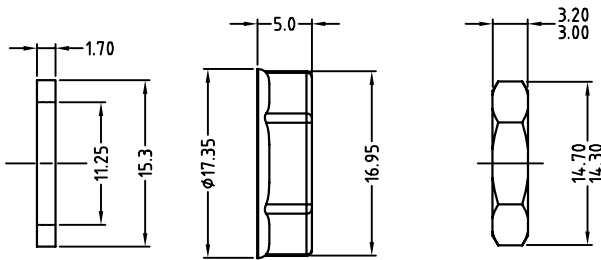
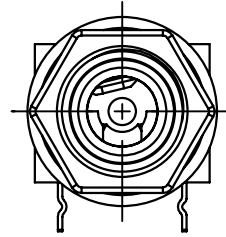
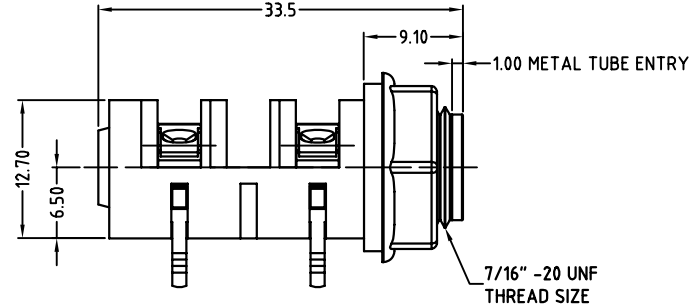
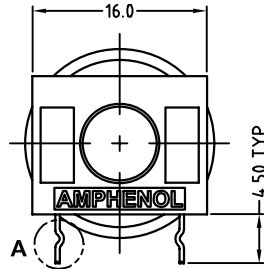

FIBER WASHER **PLASTIC NUT** **METAL NUT**

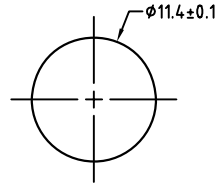

PANEL CUTOUT

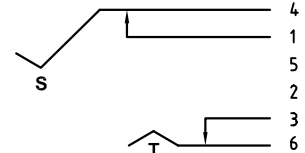

SCHEMATIC

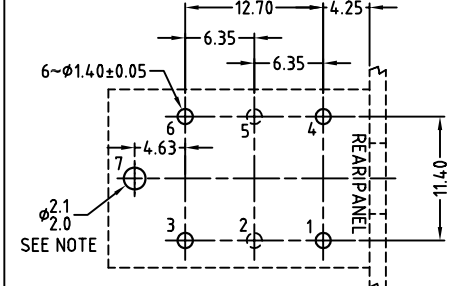

OPTIONAL PCB HOLES FOR STEREO VERSION
PCB LAYOUT
COMPONENT SIDE

CATALOGUE P/N	ASSEMBLY P/N	NUT OPTIONS
ACJM-PHDR	55010153-502	PLASTIC
ACJM-MHDR	55010153-302	METAL

NOTE: OPTIONAL MOUNTING HOLE FOR SELF-TAPPING M2 SCREW

UNLESS OTHERWISE SPECIFIED TOLERANCE TO BE		THIS DOCUMENT IS THE PROPERTY OF AMPHENOL AUSTRALIA PTY. LTD. NO PART THEREOF MAY BE REPRODUCED AND USED WITHOUT THE PRIOR WRITTEN CONSENT OF THE OWNER			
LINEAR	ANGULAR	CAD FILE: 55010153502222	DRN: L.V	DATE: 18-06-02	TITLE:
X ± 0.5	X° ± 1°	MATL: REFER TO COMPONENTS	CKD: M.N.H	DATE: 13-02-09	1/4" PHONE MONO JACK
X.X ± 0.1	X°X' ± 30'	DO NOT SCALE	FINISH: REFER TO COMPONENTS	DATE: 13-02-09	CUSTOMER DRAWING
X.XX ± 0.05	X°X'X" ± 15'	DIMENSIONS IN MILLIMETRES	APP'D: P.M	DATE: 13-02-09	SCALE: 2:1 UOS
BREAK ALL SHARP EDGES AND REMOVE ALL BURRS		THIRD ANGLE PROJECTION		PART No: REFER TO CHART	SIZE: A3

REV.	DESCRIPTION	BY	DATE	CHG/No
3	ADD MISSING DIMENSIONS ADD WASHER & DIMENSIONS	M.H	13-02-09	8803
2	CHANGE PLASTIC NUT FROM P/N: 52170018-531 TO P/N: 52170032-531	L.V	31-01-05	8333
1	UPDATE TO COMPLY WITH MODIFIED COMPONENTS	L.V	11-06-03	8184
0	FIRST ISSUE	L.V	18-06-02	----

Amphenol
Amphenol Australia Pty Ltd, 2 Fireweys Blvd, Keysborough, Vic 3173
DRAWING NO. 55010153-502-2
SHEET 2 OF 2