



Quality Products. Service Excellence.

Freestanding Enclosure Center Panel Supports

1418FS and HN4FS Series Enclosures



- Adapts panels, swing frames, and panel rails from single door enclosures so they can be used on double door enclosures.
- Suitable for single or dual access double door enclosures.
- Center panel support mounts into front to back mounting channels (top and bottom) found in two door enclosures.
- Allows a combination of two 20" panels in a 48" wide enclosure, two 26" panels in a 60" wide enclosure, or two 32" panels in a 72" wide enclosure.
- Width is adjustable from 1.91" to 2.34".
- Support may be positioned at any depth within the enclosure.
- Finished in white.

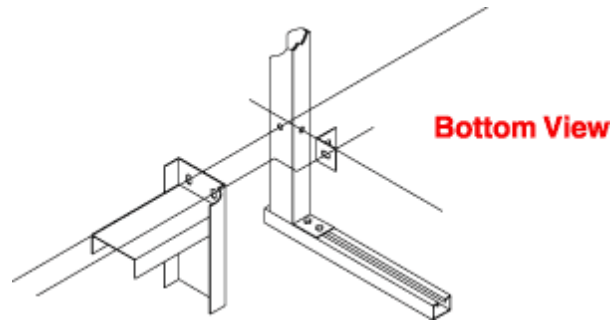

Part No.	Enclosure Ht.
1418ACS	60.00
1418ZCS	72.00
1418BCS	90.00

Data subject to change without notice

© 2023. Hammond Manufacturing Ltd. All rights reserved.