

### SOP-8EP

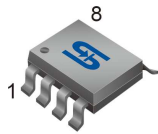

### Pin Definition:

- |         |        |
|---------|--------|
| 1. GND  | 8. OUT |
| 2. GND  | 7. OUT |
| 3. VDD  | 6. NC  |
| 4. ISET | 5. OE  |

### General Description

The TS19603 is a high voltage, low dropout current regulator of maximum output current up to 400mA. The output current is decided by an external resistor, and the output sink current could be disabled via OE pin. TS19603 internally also build-in thermal protection to prevent the chip over heat damage.

### Features

- 0.28V  $V_{DROP}$  @ 400mA
- 400mA Maximum Output Current
- Output Current Controlled by External Resistor
- 3 $\mu$ s Fast Response Output Stage Enable Control
- Wide Supply Voltage Range: 5~50V

### Applications

- High Power LED Driver
- RGB Full Color Power LED Driver
- LCD Monitor/TV LED Backlight Driver

### Typical Application Circuit

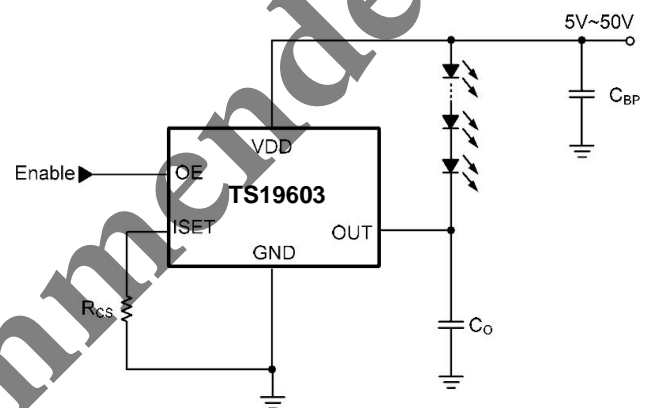

### Ordering Information

Part No.	Package	Packing
TS19603CS RLG	SOP-8EP	2.5Kpcs / 13" Reel

Note: "G" denotes Halogen Free Product.

### Absolute Maximum Rating

Parameter	Symbol	Value	Unit
Input Voltage	$V_{IN}$	55	V
Output Sink Current	$I_{OUT}$	450	mA
Output Enable Voltage	$V_{EN}$	13.2	V
Operating Junction Temperature Range	$T_{OPR}$	-40 ~ +150	$^{\circ}$ C
Storage Temperature Range	$T_{STG}$	-65 ~ +150	$^{\circ}$ C
Thermal Resistance Junction to Air	$\theta_{JA}$	80	$^{\circ}$ C/W
Power Dissipation $P_D$ @ $T_A=25^{\circ}$ C (Note 2)	$P_D$	1	W
Thermal Resistance - Junction to Ambient	$\theta_{JA}$	36	$^{\circ}$ C/W
Thermal Resistance - Junction to Case	$\theta_{JC}$	5.5	$^{\circ}$ C/W
ESD Rating (Human Body Model) (Note 4)	ESD	2	kV

### Recommend Operating Conditions

Parameter	Symbol	Min	Typ	Max	Unit
Input Voltage	$V_{IN}$	5	--	50	V
Output Enable Voltage	$V_{EN}$	0	--	12	V
Output Sink Current	$I_{OUT}$	200	--	400	mA
Operating Junction Temperature Range	$T_{OPR}$	-20	--	+125	$^{\circ}$ C
Operating Free-Air Temperature Range	$T_A$	-20	--	+85	$^{\circ}$ C

**Electrical Specification** ( $V_{IN}=24V$ ,  $T_A=25^{\circ}C$ , unless otherwise specified.)

Parameter	Conditions	Min	Typ	Max	Unit
Output Current	$V_{OUT}=0.5V$ , $R_{SET}=3k\Omega$	--	200	--	mA
	$V_{OUT}=0.5V$ , $R_{SET}=1.5k\Omega$	--	400	--	
Output Current Deviation	$V_{OUT}=0.5V$ , $I_{OUT}=200mA\sim 400mA$	--	--	$\pm 5$	%
SET Current Range		200	--	900	$\mu A$
Minimum Output Current	$I_{SET}=200\mu A$	--	100	--	mA
Maximum Output Current	$I_{SET}=900\mu A$	--	450	--	mA
Output Dropout Voltage	$I_{SET}=800\mu A$ (Note 1)	--	0.28	--	V
Load Regulation	$V_{OUT}=0.5V$ to $3V$ , $I_{OUT}=200mA$	--	--	3	mA/V
Line Regulation	$V_{OUT}=0.5V$ , $I_{OUT}=350mA$ , $V_{IN}=5\sim 50V$	--	0.08	0.15	%/V
Enable Low Input Voltage		0	--	0.8	V
Enable High Input Voltage	Should lower than $V_{IN}$	2	--	12	V
Enable Low Input Current		-20	--	+20	$\mu A$
Enable High Input Current		-5	--	+5	$\mu A$
Output Enable Delay Time	EN from low to high. $V_{OUT}=0.5V$ , $I_{OUT}=350mA$ , Duty 50%	--	3	--	$\mu S$
Output Disable Delay Time	EN from high to low. $V_{OUT}=0.5V$ , $I_{OUT}=350mA$ , Duty 50%	--	3	--	$\mu S$
Supply Current Consumption		--	--	5	mA

**Note 1:** Output Dropout Voltage: Duty 90% x  $I_{OUT}$  @  $V_{OUT}=0.5V$

**Note 2:** Stresses listed as the above "Absolute Maximum Ratings" may cause permanent damage to the device. These are for stress ratings. Functional operation of the device at these or any other conditions beyond those indicated in the operational sections of the specifications is not implied. Exposure to absolute maximum rating conditions for extended periods may remain possibility to affect device reliability.

**Note 3:** Thermal Resistance is specified with the component mounted on a low effective thermal conductivity test board in free air at  $T_A=25^{\circ}C$ .

**Note 4:** 2 square inch of FR-4, double sided, 1 oz. minimum copper weight.

**Note 5:** Devices are ESD sensitive. Handling precaution recommended.

**Pin Function Description**

Pin Name	Pin Function
VIN	Power Supply Pin
OUT	Output pin. Sink current is decided by the current on $R_{SET}$ connected to $I_{SET}$ pin. $I_{SET}=1.2V \times 500/R_{CS}$
GND	Ground Pin
OE	Output Stage Enable Control pin. High enable the output pin. It can be left floating for normally on.
ISET	Output Current Setting pin. Connect a resistor from ISET to GND to set the LED bias current $I_{SET}=0.002 \times I_{OUT}=1.2V/R_{CS}$

### Application Information

TS19603 is a high voltage, low dropout current regulator for maximum output current up to 400mA with OE pin control. The current could be linearly adjusted through variable resistor connected to ISET pin, or by PWM control via OE pin. Although the absolute maximum rating of OUT pin 75V, the dropout voltage between OUT pin and GND pin should not be too large when current is sinking because of the thermal dissipation capability of the package.

Here are some of the typical application examples:

### DC Voltage Input

Any DC voltage level between 5V to 50V could be adopted as power source VDD for typical application of TS19603 as long as VDD is larger than the total forward voltage drop of the LED string (at expecting current) by 0.35V. If 50V ~ 60V voltage level is adopted as power source to positive end of the LED string, one Zener shunt regulator could be used to provide appropriate voltage to VDD pin.

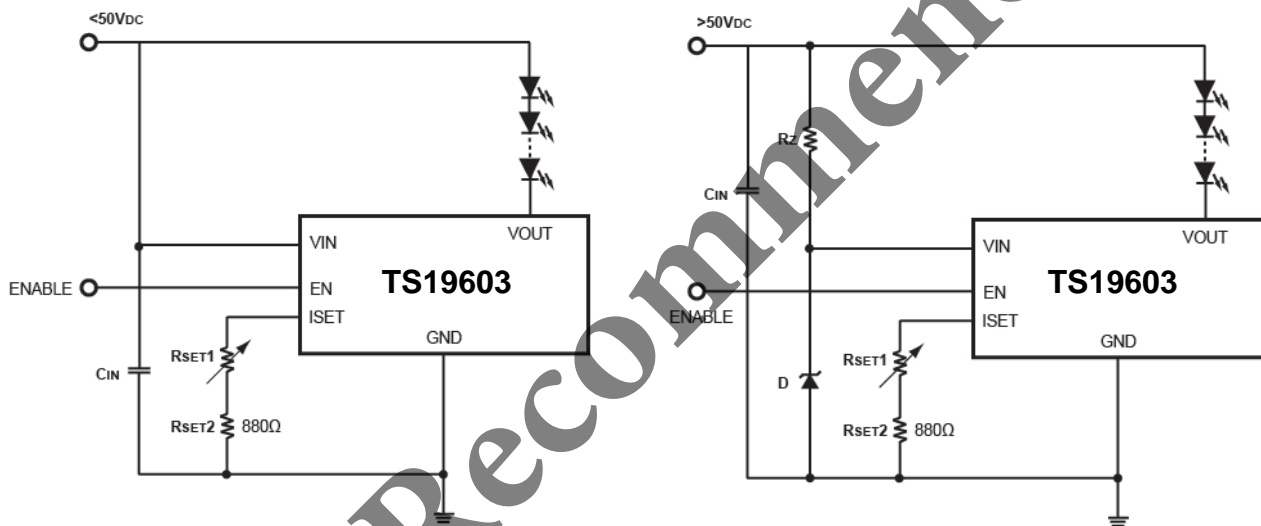

Not Recommended

### Application Information (Continue)

#### LED Backlight Solution

TS19603 could coordinate with any type of DC-to-DC converter through feedback path to realized LED backlight module. The number of LEDs in the string is variable even with certain fixed power source since the output voltage of the DC-to-DC converter could be modulated according to feedback signal.

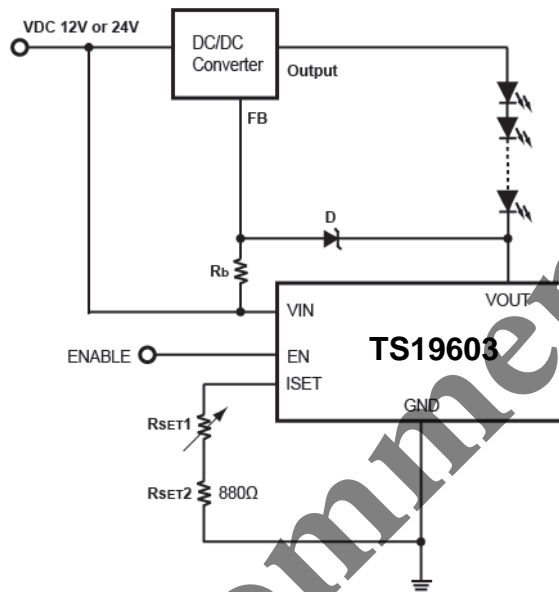

#### AC Voltage Input

TS19603 could work with any kind of well-known or well-developed switch-mode power supply system. Simply cut off the internal feedback path of the power supply system and then feed the signal from TS19603 back to the power supply system instead.

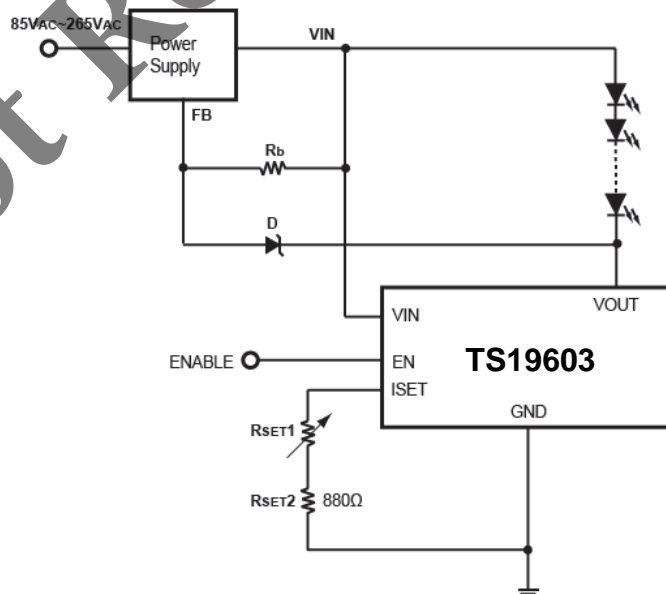

**SOP-8EP Mechanical Drawing**

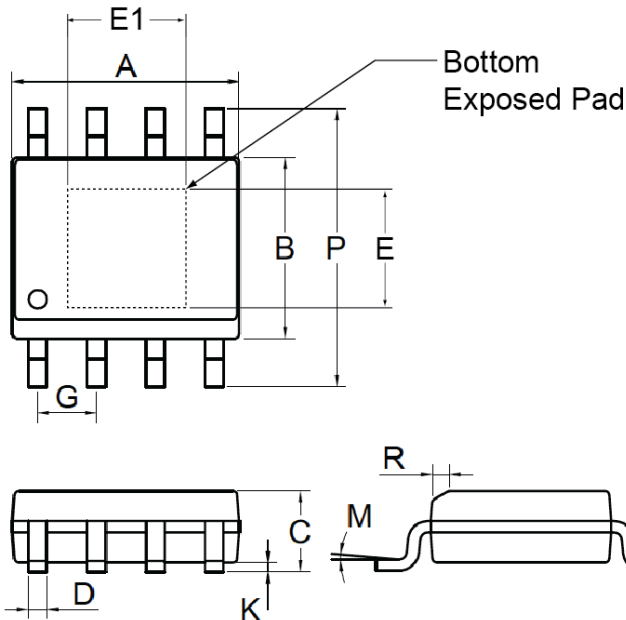

DIM	MILLIMETERS		INCHES	
	MIN	MAX	MIN	MAX.
A	4.80	5.00	0.189	0.196
B	3.80	4.00	0.150	0.157
C	1.35	1.75	0.054	0.068
D	0.35	0.49	0.014	0.019
E	2.05	2.41	0.081	0.095
E1	2.82	3.30	0.111	0.130
F	0.40	1.25	0.016	0.049
G	1.27BSC		0.05BSC	
K	0.10	0.25	0.004	0.009
M	0°	7°	0°	7°
P	5.80	6.20	0.229	0.244
R	0.25	0.50	0.010	0.019

**Marking Diagram**

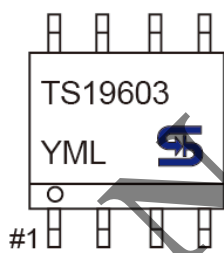

- Y** = Year Code
- M** = Month Code for Halogen Free Product  
(O=Jan, P=Feb, Q=Mar, R=Apl, S=May, T=Jun, U=Jul, V=Aug, W=Sep, X=Oct, Y=Nov, Z=Dec)
- L** = Lot Code

**Not Recommended**

### Notice

Specifications of the products displayed herein are subject to change without notice. TSC or anyone on its behalf, assumes no responsibility or liability for any errors or inaccuracies.

Information contained herein is intended to provide a product description only. No license, express or implied, to any intellectual property rights is granted by this document. Except as provided in TSC's terms and conditions of sale for such products, TSC assumes no liability whatsoever, and disclaims any express or implied warranty, relating to sale and/or use of TSC products including liability or warranties relating to fitness for a particular purpose, merchantability, or infringement of any patent, copyright, or other intellectual property right.

The products shown herein are not designed for use in medical, life-saving, or life-sustaining applications. Customers using or selling these products for use in such applications do so at their own risk and agree to fully indemnify TSC for any damages resulting from such improper use or sale.