

NRVHP820MFD

Switch-Mode Power Rectifier

This ultrafast rectifier in the dual flag SO–8 flat lead package offers designers a unique degree of versatility and design freedom. The two devices are electrically independent and can be used separately, as common cathode, as common anode or in series as a function of board level layout. The exposed pad design provides low thermal resistance. The clip attach design creates a package with very efficient die size to board area ratio. While thermal performance is nearly the same as the DPAK package height and board footprint are less than half.

Features

- New Package Provides Capability of Inspection and Probe After Board Mounting
- Low Forward Voltage Drop
- 175°C Operating Junction Temperature
- NRV Prefix for Automotive and Other Applications Requiring Unique Site and Control Change Requirements; AEC–Q101 Qualified and PPAP Capable
- These are Pb–Free and Halide–Free Devices

Mechanical Characteristics:

- Case: Epoxy, Molded
- Epoxy Meets Flammability Rating UL 94–0 @ 0.125 in.
- Lead Finish: 100% Matte Sn (Tin)
- Lead and Mounting Surface Temperature for Soldering Purposes: 260°C Max. for 10 Seconds
- Device Meets MSL 1 Requirements

Applications

- Excellent Alternative to DPAK in Space–Constrained Automotive Applications
- Output Rectification in Switching Power Supplies
- Freewheeling Diode used with Inductive Loads



ON Semiconductor®

www.onsemi.com

ULTRAFAST RECTIFIER 8 AMPERES (4x2), 200 VOLTS

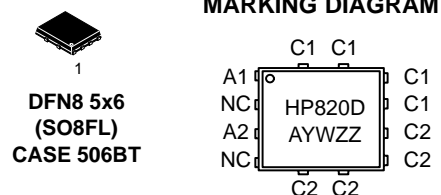

DFN8 5x6
(SO8FL)
CASE 506BT

HP820D = Specific Device Code
A = Assembly Location
Y = Year
W = Work Week
ZZ = Lot Traceability

ORDERING INFORMATION

| Device | Package | Shipping† |
|------------------|-------------------|-----------------------|
| NRVHP820MFDT1G | DFN8 (Pb–Free) | 1500 / Tape & Reel |
| NRVHP820MFDT3G | DFN8 (Pb–Free) | 5000 / Tape & Reel |
| NRVHP820MFDWFT1G | DFN8 (Pb–Free) | 1500 / Tape & Reel |
| NRVHP820MFDWFT3G | DFN8 (Pb–Free) | 5000 / Tape & Reel |

†For information on tape and reel specifications, including part orientation and tape sizes, please refer to our Tape and Reel Packaging Specification Brochure, BRD8011/D.

NRVHP820MFD

MAXIMUM RATINGS (per diode unless noted)

| Rating | Symbol | Value | Unit |
|---|---------------------------------|-------------|------------------|
| Peak Repetitive Reverse Voltage Working Peak Reverse Voltage DC Blocking Voltage | V_{RRM} V_{RWM} V_R | 200 | V |
| Average Rectified Forward Current (Rated V_R , $T_C = 170^\circ\text{C}$) | $I_{F(AV)}$ | 4.0 | A |
| Peak Repetitive Forward Current, (Rated V_R , Square Wave, 20 kHz, $T_C = 169^\circ\text{C}$) | I_{FRM} | 8.0 | A |
| Non-Repetitive Peak Surge Current (Surge Applied at Rated Load Conditions Halfwave, Single Phase, 60 Hz) | I_{FSM} | 80 | A |
| Storage Temperature Range | T_{stg} | -65 to +175 | $^\circ\text{C}$ |
| Operating Junction Temperature | T_J | -55 to +175 | $^\circ\text{C}$ |
| Unclamped Inductive Switching Energy (10 mH Inductor, Non-repetitive) | E_{AS} | 20 | mJ |
| ESD Rating (Human Body Model) | | 2 | |
| ESD Rating (Machine Model) | | M4 | |

Stresses exceeding those listed in the Maximum Ratings table may damage the device. If any of these limits are exceeded, device functionality should not be assumed, damage may occur and reliability may be affected.

THERMAL CHARACTERISTICS (per diode unless noted)

| Characteristic | Symbol | Typ | Max | Unit |
|---|-----------------|-----|-----|--------------------|
| Thermal Resistance, Junction-to-Case, Steady State (Assumes 600 mm ² 1 oz. copper bond pad, on a FR4 board) | $R_{\theta JC}$ | - | 2.9 | $^\circ\text{C/W}$ |

ELECTRICAL CHARACTERISTICS (per diode unless noted)

| | | | | |
|--|----------|------------------------------|------------------------------|---------------|
| Instantaneous Forward Voltage (Note 1) ($i_F = 4.0$ Amps, $T_J = 125^\circ\text{C}$) ($i_F = 4.0$ Amps, $T_J = 25^\circ\text{C}$) ($i_F = 8.0$ Amps, $T_J = 125^\circ\text{C}$) ($i_F = 8.0$ Amps, $T_J = 25^\circ\text{C}$) | V_F | 0.71 0.85 0.72 0.92 | 0.80 0.95 0.90 1.05 | V |
| Instantaneous Reverse Current (Note 1) (Rated dc Voltage, $T_J = 125^\circ\text{C}$) (Rated dc Voltage, $T_J = 25^\circ\text{C}$) | i_R | 2.00 0.02 | 35 0.5 | μA |
| Reverse Recovery Time $I_F = 3.0$ A, $V_R = 30$ V, $di/dt = 50$ A/ μs , $T_J = 25^\circ\text{C}$ | t_{rr} | 24 | 30 | ns |
| Reverse Recovery Time $I_F = 3.0$ A, $V_R = 30$ V, $di/dt = 50$ A/ μs , $T_J = 125^\circ\text{C}$ | t_{rr} | 27 | 50 | ns |

Product parametric performance is indicated in the Electrical Characteristics for the listed test conditions, unless otherwise noted. Product performance may not be indicated by the Electrical Characteristics if operated under different conditions.

1. Pulse Test: Pulse Width = 300 μs , Duty Cycle $\leq 2.0\%$.

NRVHP820MFD

TYPICAL CHARACTERISTICS

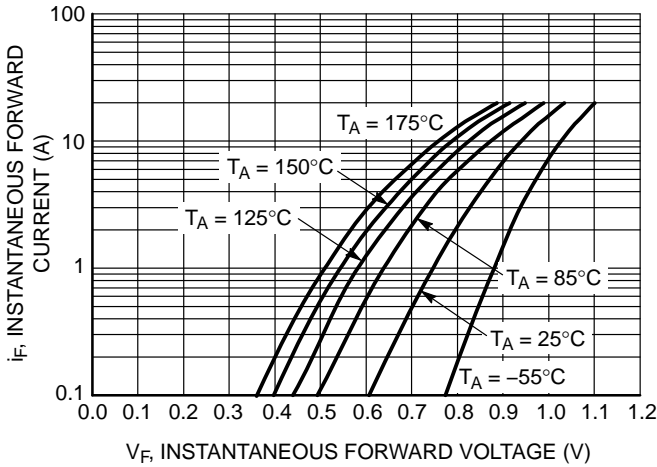

Figure 1. Typical Instantaneous Forward Characteristics

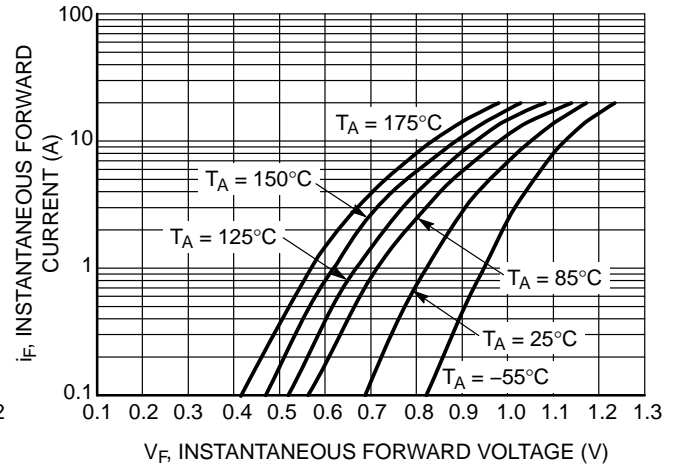

Figure 2. Maximum Instantaneous Forward Characteristics

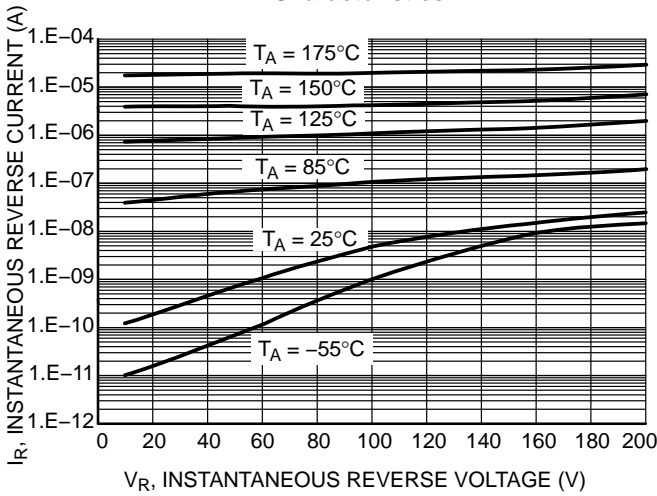

Figure 3. Typical Reverse Characteristics

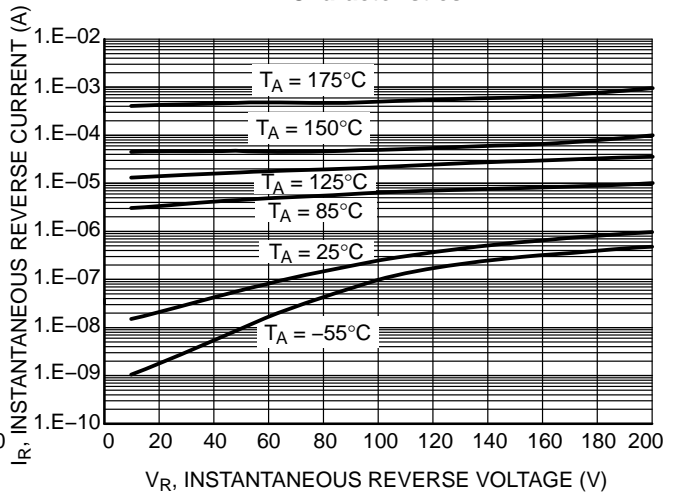

Figure 4. Maximum Reverse Characteristics

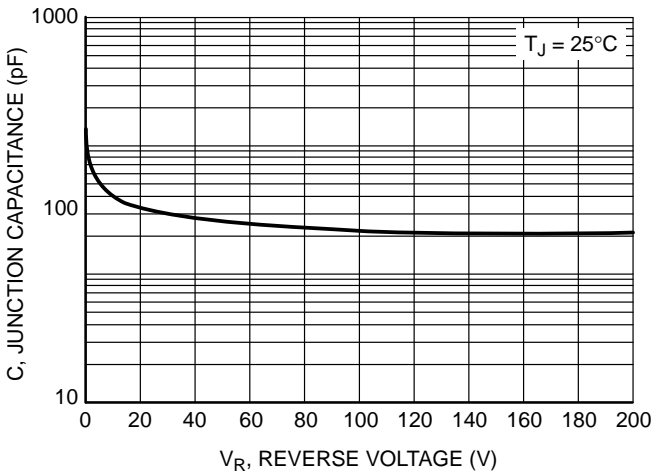

Figure 5. Typical Junction Capacitance

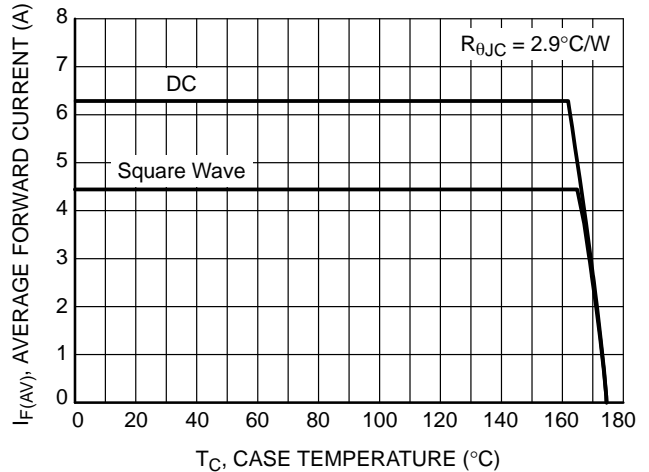

Figure 6. Current Derating per Device

NRVHP820MFD

TYPICAL CHARACTERISTICS

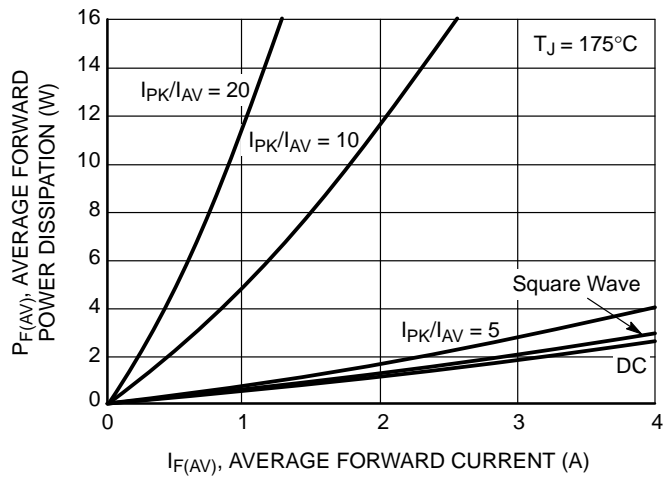

Figure 7. Forward Power Dissipation

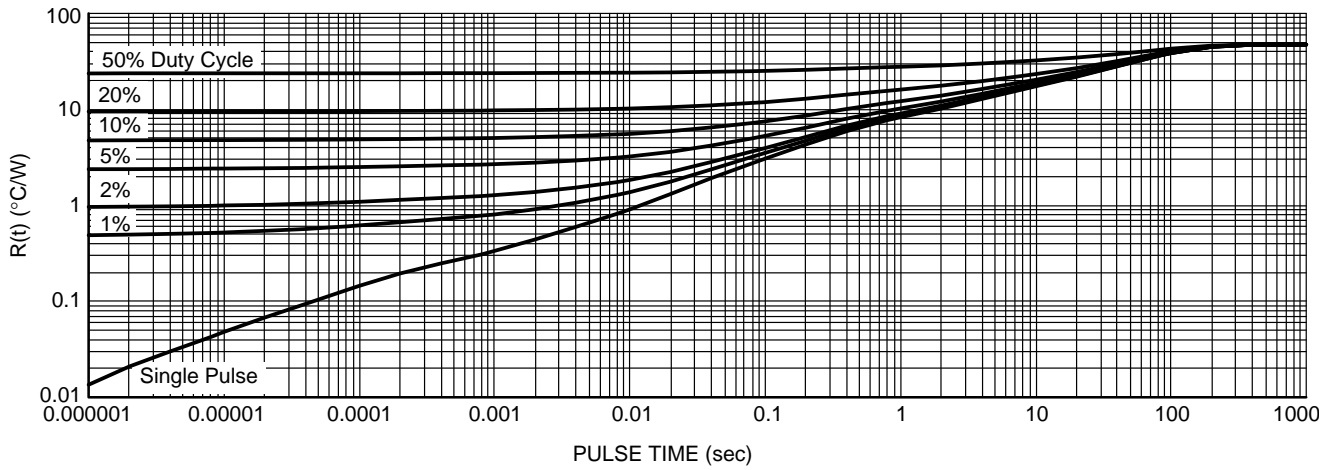
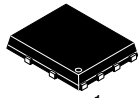

Figure 8. Typical Thermal Characteristics

MECHANICAL CASE OUTLINE PACKAGE DIMENSIONS



SCALE 2:1

DFN8 5x6, 1.27P Dual Flag (SO8FL-Dual) CASE 506BT ISSUE F

DATE 23 NOV 2021

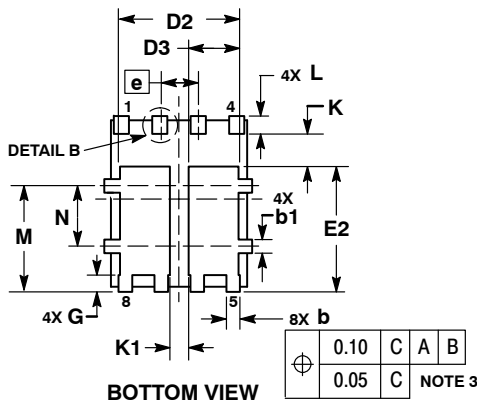
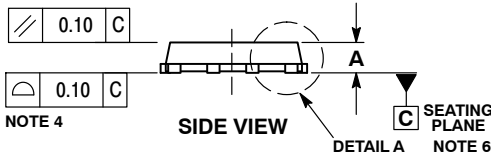
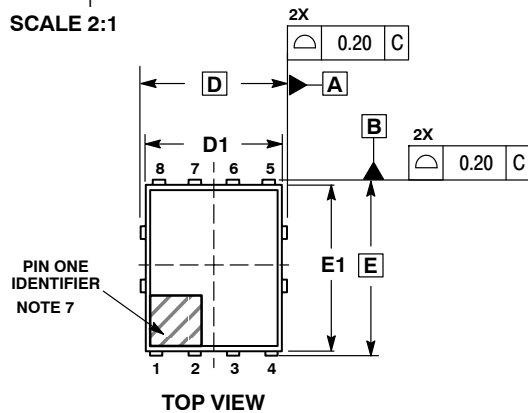

GENERIC MARKING DIAGRAM*

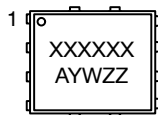

XXXXXX = Specific Device Code
A = Assembly Location
Y = Year
W = Work Week
ZZ = Lot Traceability

*This information is generic. Please refer to device data sheet for actual part marking. Pb-Free indicator, "G" or microdot "•", may or may not be present. Some products may not follow the Generic Marking.

NOTES:

1. DIMENSIONING AND TOLERANCING PER ASME Y14.5M, 1994.
2. CONTROLLING DIMENSION: MILLIMETERS.
3. DIMENSION b APPLIES TO PLATED TERMINAL AND IS MEASURED BETWEEN 0.15 AND 0.30 MM FROM THE TERMINAL TIP.
4. PROFILE TOLERANCE APPLIES TO THE EXPOSED PAD AS WELL AS THE TERMINALS.
5. DIMENSIONS D1 AND E1 DO NOT INCLUDE MOLD FLASH, PROTRUSIONS, OR GATE BURRS.
6. SEATING PLANE IS DEFINED BY THE TERMINALS. A1 IS DEFINED AS THE DISTANCE FROM THE SEATING PLANE TO THE LOWEST POINT ON THE PACKAGE BODY.
7. A VISUAL INDICATOR FOR PIN 1 MUST BE LOCATED IN THIS AREA.

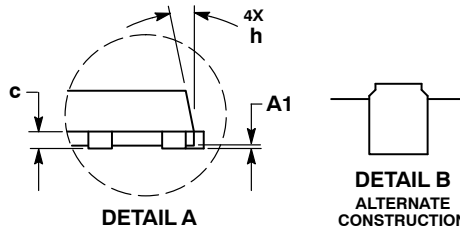

| DIM | MILLIMETERS | | |
|-----|-------------|------|------|
| | MIN | NOM | MAX |
| A | 0.90 | --- | 1.10 |
| A1 | --- | --- | 0.05 |
| b | 0.33 | 0.42 | 0.51 |
| b1 | 0.33 | 0.42 | 0.51 |
| c | 0.20 | --- | 0.33 |
| D | 5.15 BSC | | |
| D1 | 4.70 | 4.90 | 5.10 |
| D2 | 3.90 | 4.10 | 4.30 |
| D3 | 1.50 | 1.70 | 1.90 |
| E | 6.15 BSC | | |
| E1 | 5.70 | 5.90 | 6.10 |
| E2 | 3.90 | 4.15 | 4.40 |
| e | 1.27 BSC | | |
| G | 0.45 | 0.55 | 0.65 |
| h | --- | --- | 12 ° |
| K | 0.51 | --- | --- |
| K1 | 0.56 | --- | --- |
| L | 0.48 | 0.61 | 0.71 |
| M | 3.25 | 3.50 | 3.75 |
| N | 1.80 | 2.00 | 2.20 |

SOLDERING FOOTPRINT*

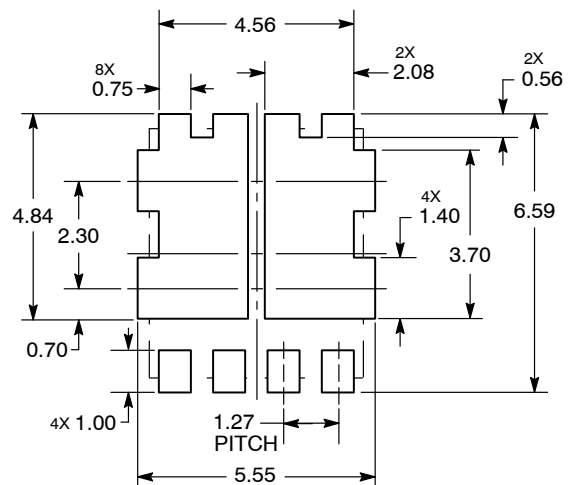

DIMENSION: MILLIMETERS

*For additional information on our Pb-Free strategy and soldering details, please download the ON Semiconductor Soldering and Mounting Techniques Reference Manual, SOLDERRM/D.

| | | |
|------------------|--|--|
| DOCUMENT NUMBER: | 98AON50417E | Electronic versions are uncontrolled except when accessed directly from the Document Repository. Printed versions are uncontrolled except when stamped "CONTROLLED COPY" in red. |
| DESCRIPTION: | DFN8 5X6, 1.27P DUAL FLAG (SO8FL-DUAL) | PAGE 1 OF 1 |

onsemi and ONSEMI are trademarks of Semiconductor Components Industries, LLC dba onsemi or its subsidiaries in the United States and/or other countries. onsemi reserves the right to make changes without further notice to any products herein. onsemi makes no warranty, representation or guarantee regarding the suitability of its products for any particular purpose, nor does onsemi assume any liability arising out of the application or use of any product or circuit, and specifically disclaims any and all liability, including without limitation special, consequential or incidental damages. onsemi does not convey any license under its patent rights nor the rights of others.

onsemi, **Onsemi**, and other names, marks, and brands are registered and/or common law trademarks of Semiconductor Components Industries, LLC dba "**onsemi**" or its affiliates and/or subsidiaries in the United States and/or other countries. **onsemi** owns the rights to a number of patents, trademarks, copyrights, trade secrets, and other intellectual property. A listing of **onsemi**'s product/patent coverage may be accessed at www.onsemi.com/site/pdf/Patent-Marking.pdf. **onsemi** reserves the right to make changes at any time to any products or information herein, without notice. The information herein is provided "as-is" and **onsemi** makes no warranty, representation or guarantee regarding the accuracy of the information, product features, availability, functionality, or suitability of its products for any particular purpose, nor does **onsemi** assume any liability arising out of the application or use of any product or circuit, and specifically disclaims any and all liability, including without limitation special, consequential or incidental damages. Buyer is responsible for its products and applications using **onsemi** products, including compliance with all laws, regulations and safety requirements or standards, regardless of any support or applications information provided by **onsemi**. "Typical" parameters which may be provided in **onsemi** data sheets and/or specifications can and do vary in different applications and actual performance may vary over time. All operating parameters, including "Typicals" must be validated for each customer application by customer's technical experts. **onsemi** does not convey any license under any of its intellectual property rights nor the rights of others. **onsemi** products are not designed, intended, or authorized for use as a critical component in life support systems or any FDA Class 3 medical devices or medical devices with a same or similar classification in a foreign jurisdiction or any devices intended for implantation in the human body. Should Buyer purchase or use **onsemi** products for any such unintended or unauthorized application, Buyer shall indemnify and hold **onsemi** and its officers, employees, subsidiaries, affiliates, and distributors harmless against all claims, costs, damages, and expenses, and reasonable attorney fees arising out of, directly or indirectly, any claim of personal injury or death associated with such unintended or unauthorized use, even if such claim alleges that **onsemi** was negligent regarding the design or manufacture of the part. **onsemi** is an Equal Opportunity/Affirmative Action Employer. This literature is subject to all applicable copyright laws and is not for resale in any manner.

PUBLICATION ORDERING INFORMATION

LITERATURE FULFILLMENT:

Email Requests to: orderlit@onsemi.com

onsemi Website: www.onsemi.com

TECHNICAL SUPPORT

North American Technical Support:
Voice Mail: 1 800-282-9855 Toll Free USA/Canada
Phone: 011 421 33 790 2910

Europe, Middle East and Africa Technical Support:

Phone: 00421 33 790 2910

For additional information, please contact your local Sales Representative