

Using the TPS40200

The TPS40200EVM-001 evaluation module (EVM) uses the TPS40200 nonsynchronous buck converter to provide a resistor-selected 3.3-V output voltage that delivers up to 2.5 A from a 12-V input bus. The EVM operates from a single supply and uses a single P-channel power FET and Schottky diode to produce a low-cost buck converter. The part operates at a 300-kHz clock frequency with provision for external frequency synchronization.

Contents

1	Description	2
2	TPS40200EVM-001 Electrical and Performance Specifications.....	2
3	Schematic.....	3
4	Test Setup	6
5	TPS40200EVM Typical Performance Data and Characteristic Curves.....	9
6	EVM Assembly Drawings and Layout	10
7	List of Materials.....	15

List of Figures

1	TPS40200EVM-001 Schematic.....	3
2	TPS40200 Synchronized to a 50% Duty Cycle External Clock.....	5
3	TPS40200EVM-001 Recommended Test Setup	7
4	Output Ripple Measurement - Tip and Barrel Using TP14 and TP15	8
5	TPS40200EVM-001 Efficiency	9
6	TPS40200EVM-001 Efficiency	9
7	TPS40200EVM-001 Line and Load Regulation – V _{out} = 3.3255 V	10
8	TPS40200EVM-001 Line and Load Regulation – V _{out} = 5.0665 V	10
9	TPS40200EVM-001 Component Placement (Viewed from Top)	11
10	TPS40200EVM-001 Silkscreen (Viewed from Top)	12
11	TPS40200EVM-001 Top View.....	13
12	TPS40200EVM-001 Bottom View.....	14

List of Tables

1	Adjusting V _{OUT} With R ₆ Rounded to Standard 1% Resistor Values	4
2	TPS40200EVM-001 Bill of Materials.....	15

1 Description

TPS40200EVM-001 is designed to operate with an 8-V to 16-V input and to produce a regulated 3.3-V output with a load current from 0.125 A to 2.5 A. The TPS40200EVM-001 demonstrates the use of the TPS40200 in a typical buck converter application. The board sacrifices some packing density to provide ample test points for module evaluation. This EVM can be modified to support output voltages from 0.7 V to 5 V by changing a single feedback resistor. The TPS40200EVM-001 has been built to the sample application as described in the Application Information section of the TPS40200 data sheet ([SLUS659](#)).

1.1 Features

- 8-V to 16-V input range
- 3.3-V output, adjustable with single feedback resistor
- 0.125-A to 2.5-A steady-state output current
- 300-kHz switching frequency
- Single P-channel MOSFET and single rectifier
- Two-layer, 1.4-inch × 2.12-inch, surface-mount design with all components on one side
- Convenient test points for probing critical waveforms and noninvasive loop response testing

1.2 Applications

- Nonisolated medium-current, point-of-load and low-voltage bus converters
- Scanners
- Industrial controls
- Distributed power systems
- DSL/cable modems

2 TPS40200EVM-001 Electrical and Performance Specifications

PARAMETER		TEXT CONDITIONS	MIN	NOM	MAX	UNIT
V_{IN}	Input voltage		8	12	16	V
V_{OUT}	Output voltage	I_{OUT} at 2.5 A, $R_6 = 26.7 \text{ k}\Omega$	3.200	3.3	3.400 ⁽¹⁾	V
	Line regulation	$\pm 0.2\% V_{OUT}$	3.293	3.3	3.307	V
	Load regulation	$\pm 0.2\% V_{OUT}$	3.293	3.3	3.307	V
V_{OUT}	Output voltage	I_{OUT} at 2.5 A, $R_6 = 16.5 \text{ k}\Omega$	4.85	5	5.150 ⁽¹⁾	V
	Line regulation	$\pm 0.2\% V_{OUT}$	4.990	5	5.010	V
	Load regulation	$\pm 0.2\% V_{OUT}$	4.990	5	5.010	V
V_{RIPPLE}	Output ripple voltage	At maximum output current		60		mV
V_{OVER}	Output overshoot	For 2.375-A load transient		60		mV
V_{UNDER}	Output undershoot	For 2.375-A load transient		60		mV
I_{OUT}	Output current		0.125		2.5	A
I_{SCP}	Short-circuit current trip point	$I_{MAX} + 50\%$ minimum	3.75		5	A
	Efficiency	At nominal input voltage and maximum output current		90%		
F_S	Switching frequency			300		kHz

⁽¹⁾ Set-point accuracy depends on external resistor tolerance and the reference voltage. Line and load regulation values are referenced to the nominal design output voltage.

3 Schematic

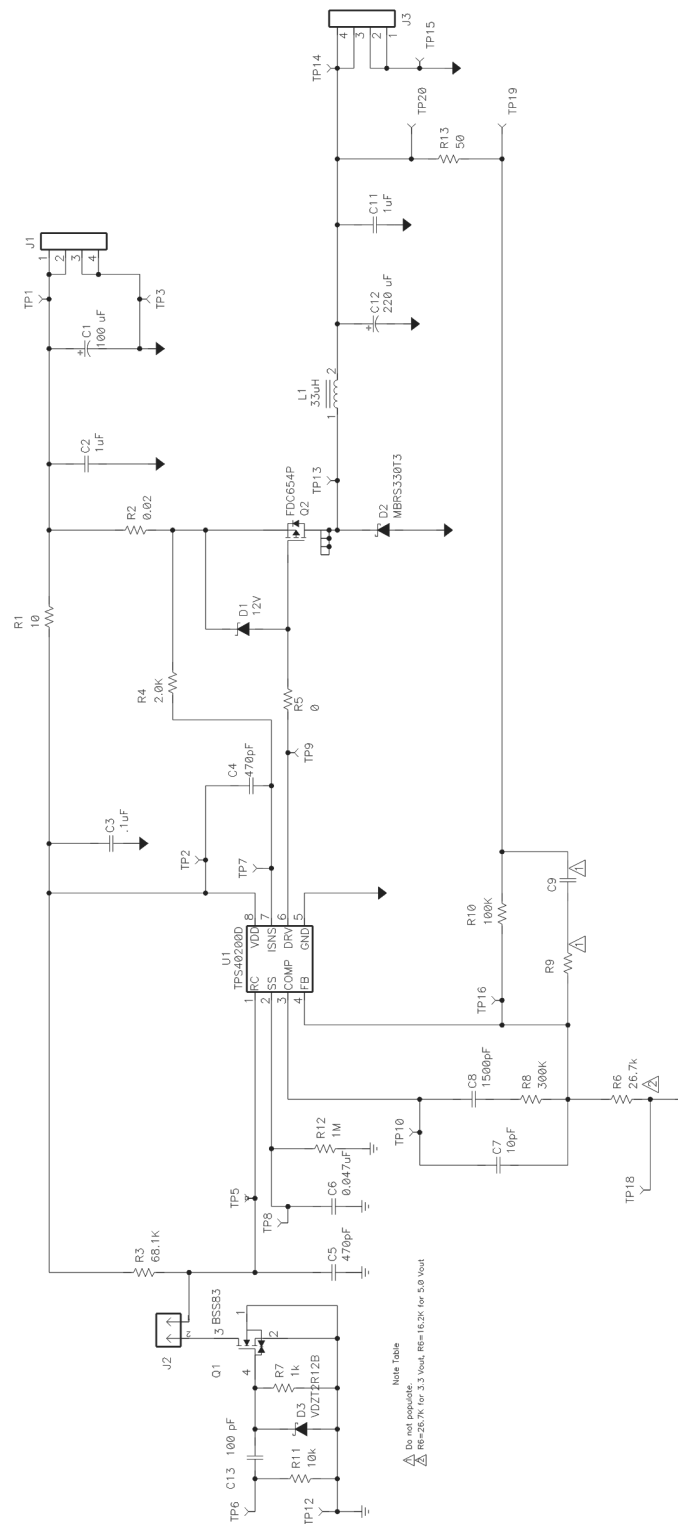

NOTE: For reference only; see Table 2, Bill of Materials for specific values

Figure 1. TPS40200EVM-001 Schematic

3.1 Adjusting Output Voltage (R6 and R10)

The regulated output voltage can be adjusted within a limited range by changing the ground resistor in the feedback resistor divider (R6 and R10). The output voltage is given by [Equation 1](#).

$$V_{\text{vout}} = V_{\text{ref}} \left(1 + \frac{R_{10}}{R_6} \right) \quad (1)$$

Where $V_{\text{REF}} = 0.700 \text{ V}$ and $R_{10} = 100 \text{ k}\Omega$

[Table 1](#) contains common values for R6 to generate popular output voltages. TPS40200EVM-001 is stable through these output voltages with the efficiency rising with output voltage.

Table 1. Adjusting V_{OUT} With R6 Rounded to Standard 1% Resistor Values

V_{OUT} - Output Voltage (V)	R6 - Feedback Resistor Divider (k Ω)
5	16.2
3.3	26.7
2.5	39
2	53.6
1.8	63.4
1.5	86.6
1.2	140

3.2 Using Remote Synchronizing (TP6)

The TPS40200EVM-001 board has a synchronizing circuit that uses TP6 as an input. A logic high at this input turns on a small signal FET (Q1) whose drain is connected to the oscillator setting node (RC) on the TPS40200. The switching of this transistor over-drives the ramp associated with the internal oscillator and causes the PWM switching to follow the input clock frequency. For reliable operation, the external clock frequency should be 25% to 30% higher than the frequency set by R3 and C5. The BSS83 used in this circuit has a low (1-pF) output capacitance; so, its presence does not load down the normal operation of the RC pin. With the controller's frequency set to a 300-kHz frequency, the module synchronizes to a 390-kHz external clock that has a 50% duty cycle. A shorting jack, J2, is provided to disconnect the synchronizing circuit from the (RC) node.

The following scope picture (Figure 2) shows a 5-V input clock at the TP6 input operating at 390 kHz and a 50% duty cycle. The switch node also shown in the picture is switching at the same frequency with a 12-V V_{CC} supply. The RC operating frequency of the TPS40200 is set by R3 and C5 to be 300 kHz.

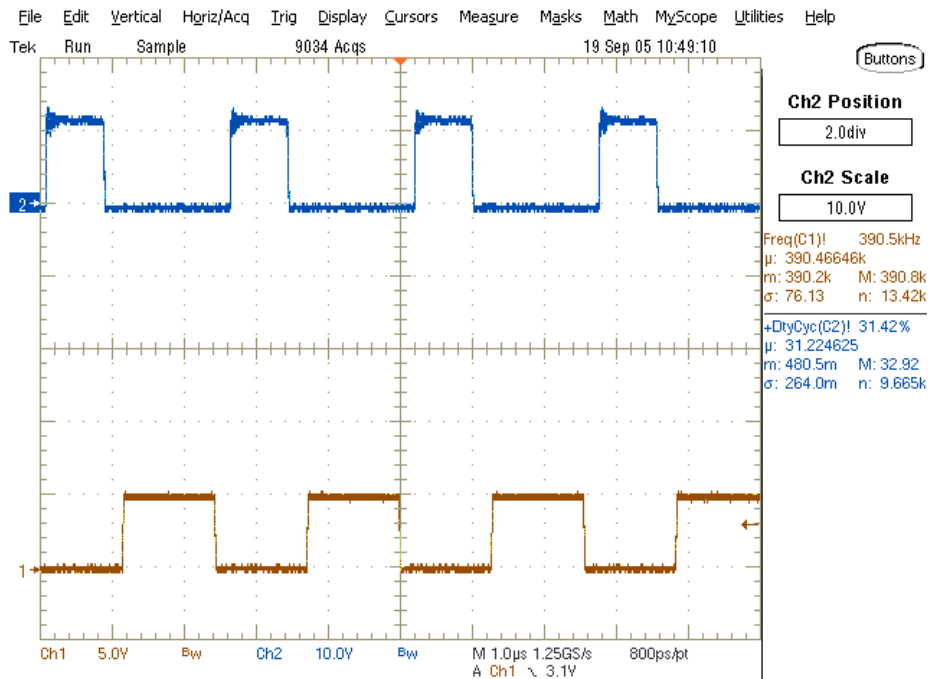

Figure 2. TPS40200 Synchronized to a 50% Duty Cycle External Clock

4 Test Setup

4.1 Equipment

4.1.1 Voltage Source

V_{12V_IN} — The input voltage source (V_{12V_IN}) should be a 0-V to 20-V variable dc source capable of 5 A dc.

METERS

A1: 0-A to 5-A dc ammeter

V1: V_{12V_IN} , 0-V to 20-V voltmeter

V2: V_{3V3_OUT} 0 V to 10-V voltmeter

4.1.2 Loads

LOAD1 — The output load (LOAD1) should be an electronic constant-current-mode load capable of 0 A-to-2.5 A dc at 1.5 V.

4.1.3 Recommended Wire Gauge

V_{12V_IN} to J1 — The connection between the source voltage, V_{12V_IN} and J1 of HPA164 can carry as much as 3 A dc. The minimum recommended wire size is AWG 16 with the length of wire less than 4 feet (2 feet input, 2 feet return).

J3 to LOAD1 (Power) — The power connection between J3 of HPA164 and LOAD1 can carry as much as 5 A dc. The minimum recommended wire size is 2x AWG 16, with the length of wire less than 4 feet (2 feet output, 2 feet return).

J3 to LOAD1 (Remote Sense) — If remote sense is used, the remote sense connection between J3 of HPA164 and LOAD1 will carry less than 1 A dc. The minimum recommended wire size is AWG 22, with the length of wire less and 4 feet (2 feet output, 2 feet return).

4.1.4 Oscilloscope

A 60-MHz or faster oscilloscope can be used to determine the ripple voltage on 3V3_OUT. The oscilloscope should be set for 1-M Ω impedance, ac coupling, 1- μ s/division horizontal resolution, 20-mV/division vertical resolution for taking output ripple measurements. TP14 and TP15 can be used to measure the output ripple voltage by placing the oscilloscope probe tip through TP14 and holding the ground barrel to TP15 as shown in [Figure 3](#). For a hands-free approach, the loop in TP15 can be cut and opened to cradle the probe barrel. Using a leaded ground connection may induce additional noise due to the large ground loop area. Connect a short wire from the barrel of the scope probe to TP15 as necessary to reach between TP14 and TP15.

4.2 Equipment Setup

Shown in Figure 3 is the basic test setup recommended to evaluate the TPS40200EVM-001. Note that although the return for J1 and J3 are the same, the connections should remain separate as shown in Figure 3.

4.2.1 Procedure

1. Working at an ESD workstation, ensure that any wrist straps, bootstraps, or mats are connected referencing the user to earth ground before power is applied to the EVM. Electrostatic smock and safety glasses should also be worn.
2. Prior to connecting the dc-input source, V_{12V_IN} , it is advisable to limit the source current from V_{12V_IN} to 5 A maximum. Ensure that V_{12V_IN} is initially set to 0 V and connected as shown in Figure 2.
3. Connect the ammeter A1 (0-A to 5-A range) between V_{12V_IN} and J1 as shown in Figure 3.
4. Connect voltmeter V1 to TP1 and TP3 as shown in Figure 3.
5. Connect LOAD1 to J3 as shown in Figure 1. Set LOAD1 to constant current mode to sink 0 A dc before V_{12V_IN} is applied.
6. Connect voltmeter, V2 across J3 pin 3 and J3 pin 2 as shown in Figure 3.
7. Connect the oscilloscope probe to TP14 and TP15 as shown in Figure 4.

4.2.2 Diagram

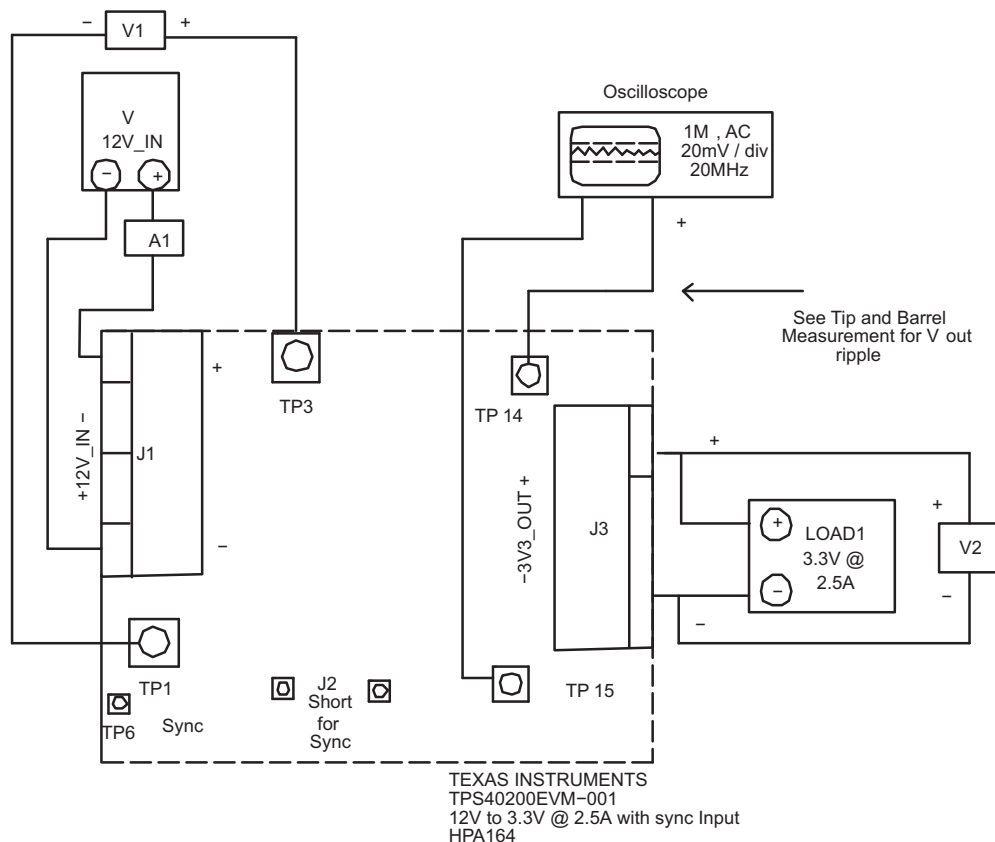

Figure 3. TPS40200EVM-001 Recommended Test Setup

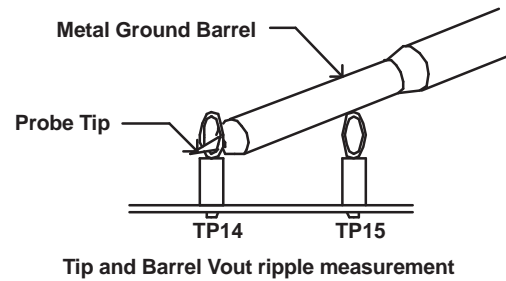

Figure 4. Output Ripple Measurement - Tip and Barrel Using TP14 and TP15

4.3 Startup/Shutdown Procedure

- a. Increase V_{12V_IN} (V1) from 0 V to 12 V dc.
- b. Vary LOAD1 from 0 A to 2.5 A dc.
- c. Vary V_{12V_IN} (V1) from 8 Vdc to 16 V dc.
- d. Decrease LOAD1 to 0 A.
- e. Decrease V_{12V_IN} to 0 V.

4.4 Equipment Shutdown

- a. Shut down oscilloscope.
- b. Shut down LOAD1.
- c. Shut down V_{12V_IN} .

5 TPS40200EVM Typical Performance Data and Characteristic Curves

Figure 5 through Figure 8 present typical performance curves for the TPS40200EVM-001. Because actual performance data can be affected by measurement techniques and environmental variables, these curves are presented for reference and may differ from actual field measurements.

5.1 Efficiency

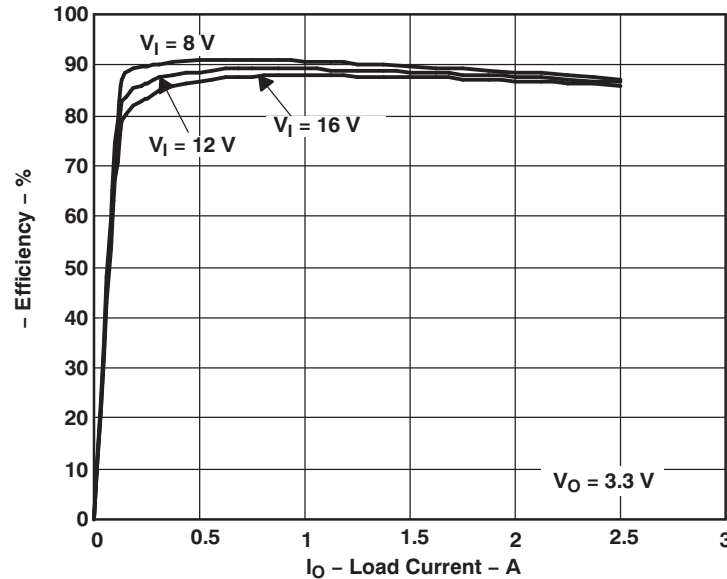

NOTE: $V_{12V_IN} = 8\text{-}, 12\text{-}, \text{ and } 16\text{-V}$, $V_{3V3_OUT} = 3.3\text{ V}$, $I_{1V5_OUT} = 0.125\text{ A to } 2.5\text{ A}$

Figure 5. TPS40200EVM-001 Efficiency

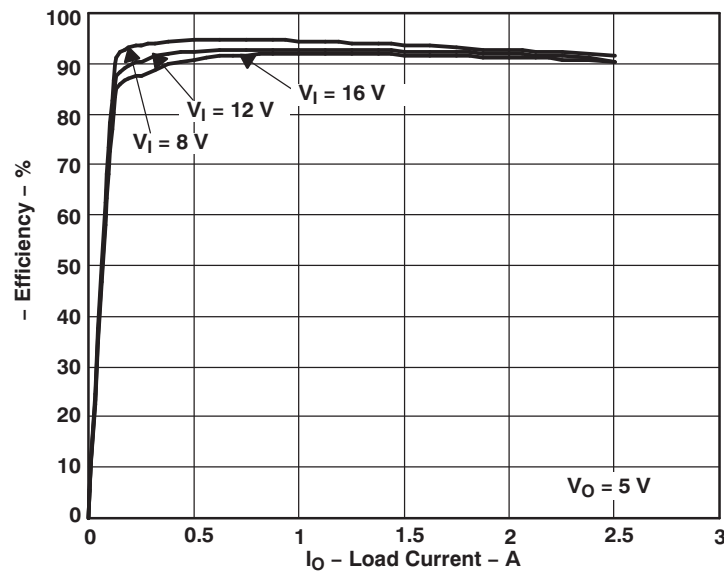

NOTE: $V_{12V_IN} = 8\text{-}, 12\text{-}, \text{ and } 16\text{-V}$, $V_{3V3_OUT} = 5\text{ V}$, $I_{1V5_OUT} = 0.125\text{ A to } 2.5\text{ A}$

Figure 6. TPS40200EVM-001 Efficiency

5.2 Line and Load Regulation

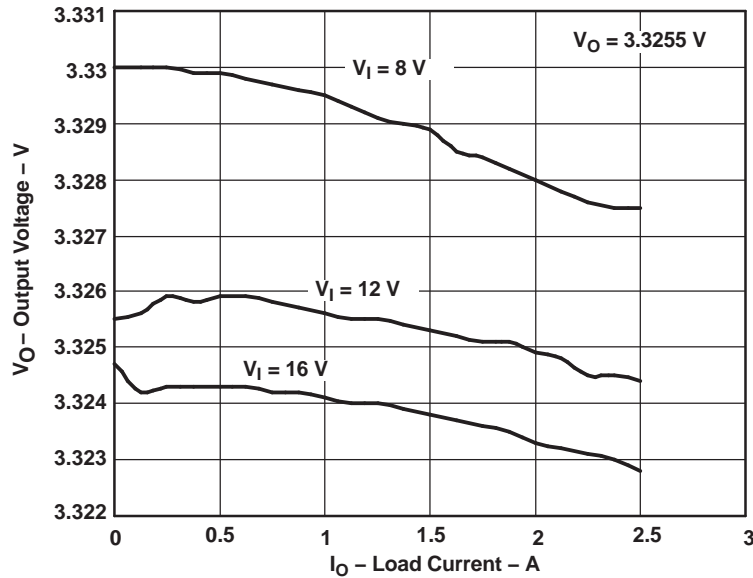

Figure 7. TPS40200EVM-001 Line and Load Regulation – $V_{out} = 3.3255\text{ V}$

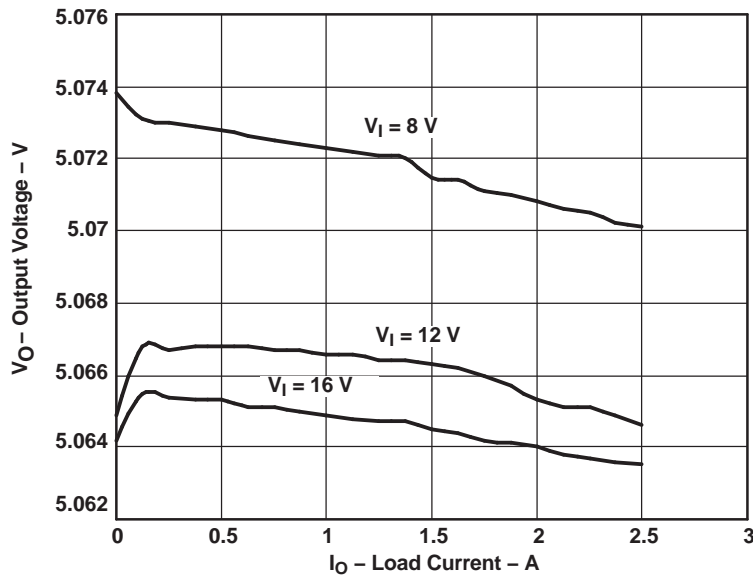

Figure 8. TPS40200EVM-001 Line and Load Regulation – $V_{out} = 5.0665\text{ V}$

6 EVM Assembly Drawings and Layout

The following figures (Figure 9 through Figure 12) show the design of the TPS40200EVM-001 printed-circuit board. The EVM has been designed using a 2-layer, 2-oz copper-clad circuit board, 1.4-inch \times 2.12-inch in size, with all components on the top side to allow the user to easily view, probe, and evaluate the TPS40200 control IC in a practical application. Moving components to both sides of the PCB or using additional internal layers can offer additional size reduction for space-constrained systems.

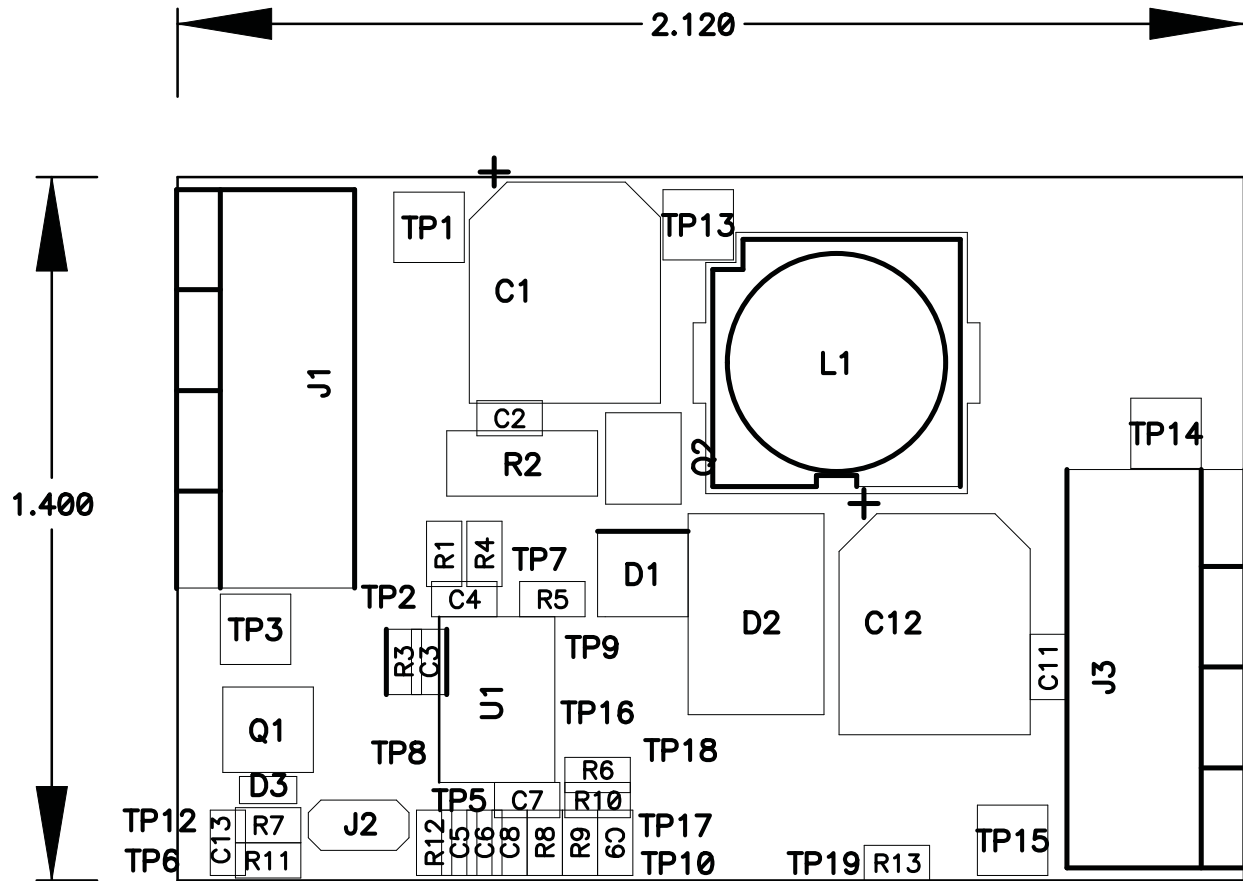

Figure 9. TPS40200EVM-001 Component Placement (Viewed from Top)

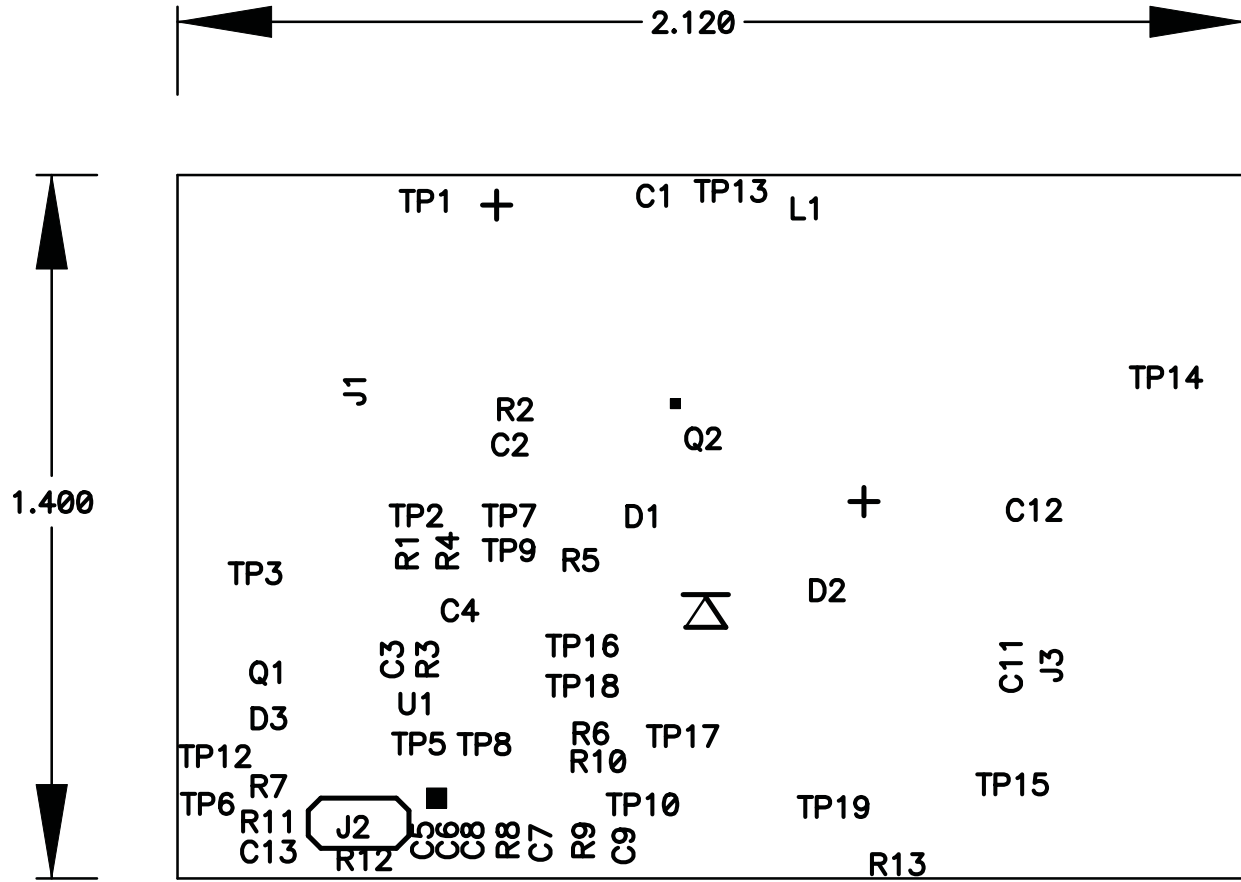

Figure 10. TPS40200EVM-001 Silkscreen (Viewed from Top)

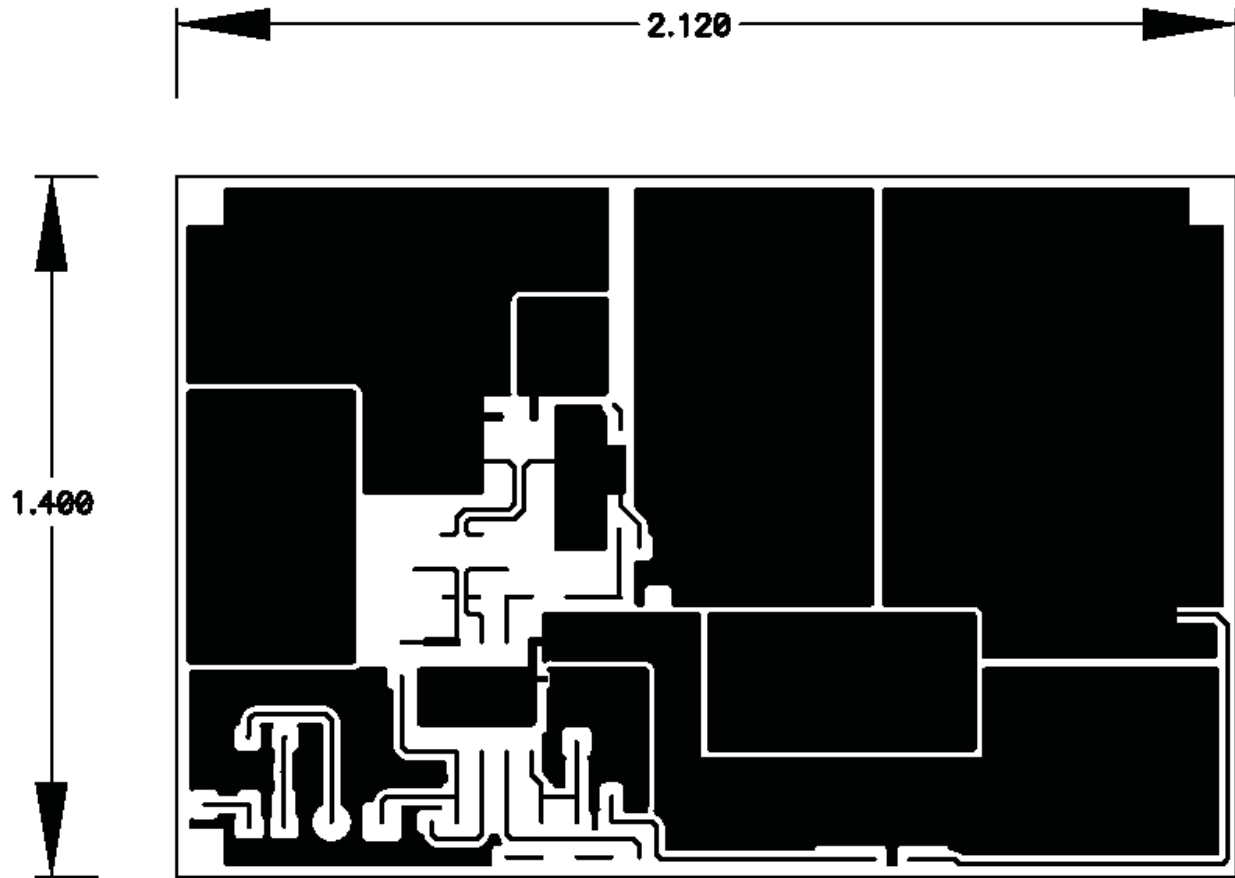

Figure 11. TPS40200EVM-001 Top View

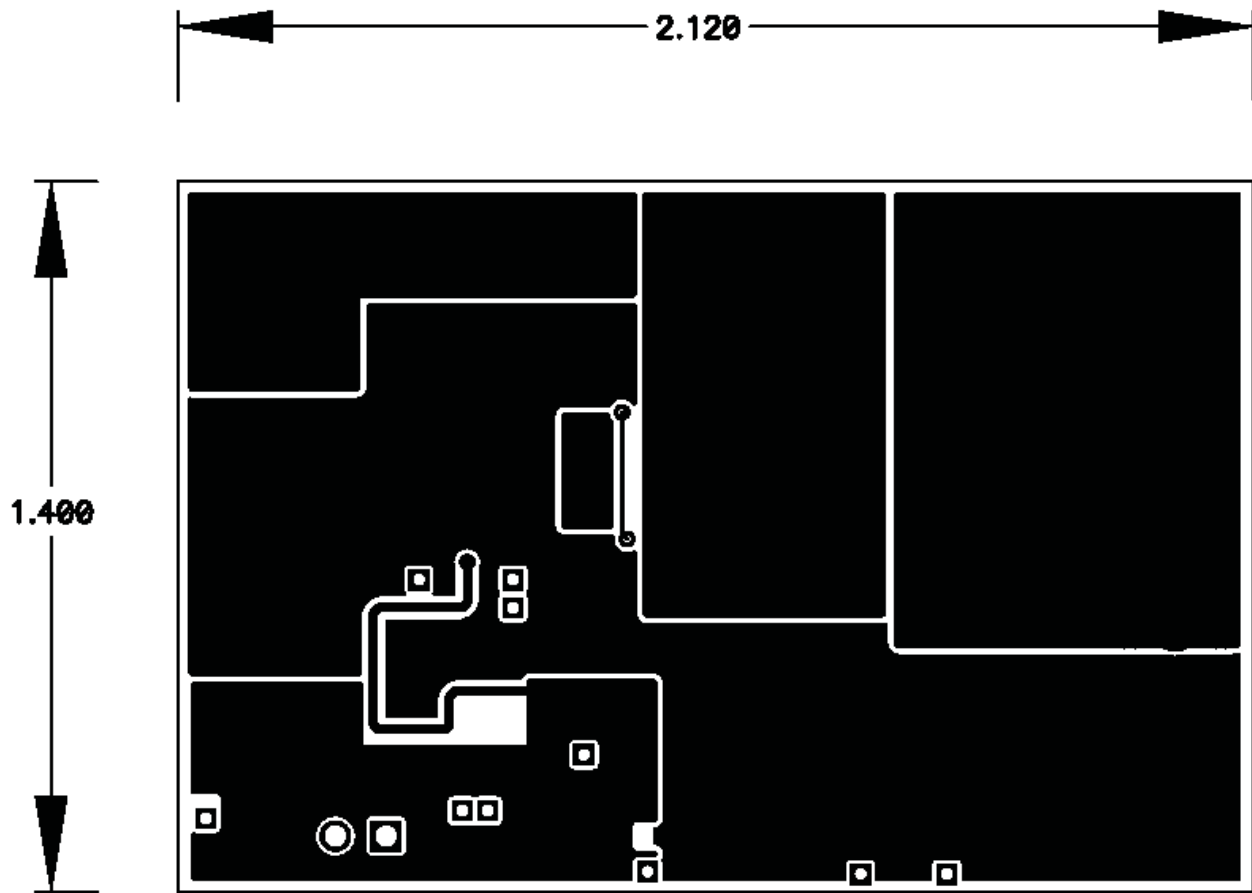

Figure 12. TPS40200EVM-001 Bottom View

7 List of Materials

Table 2 lists the EVM components as configured according to the schematic shown in Figure 1.

Table 2. TPS40200EVM-001 Bill of Materials

Count	Ref Des	Value	Description	Size	Part Number	MFR
1	C1	100 μ F	Capacitor, Aluminum, SM, 25-V, 0.3- Ω	8 x 10 mm	20SVP100M	Sanyo
2	C2, C11	1 μ F	Capacitor, Ceramic, 50-V, X7R, 20%	603	Std	Murata
1	C3	0.1 μ F	Capacitor, Ceramic, 50-V, X7R, 20%	603	Std	Murata
2	C4, C5	470 pF	Capacitor, Ceramic, 50-V, X7R, 20%	603	Std	Murata
1	C6	0.047 μ F	Capacitor, Ceramic, 50-V, X7R, 20%	603	Std	Murata
1	C7	10 pF	Capacitor, Ceramic, 50-V, COG, 20%	603	Std	Murata
1	C8	1500 pF	Capacitor, Ceramic, 50-V, X7R, 20%	603	Std	Murata
0	C9	OPEN				
1	C12	220 μ F	Capacitor, Aluminum, SM, 6.3-V, 0.4- Ω	8 x 6,2 mm	EEVFC0J221P	Panasonic
1	C13	100 pF	Capacitor, Ceramic, 50-V, COG, 20%	603	Std	Murata
1	D1	12 V	Diode, Zener, 12-V, 350-mW	SOT-23	BZX84C12T	Diodes, Inc.
1	D2	MBRS330T3	Diode, Schottky, 3-A, 30-V	SMC	MBRS330T3	On Semi
1	D3	12-V	Diode, Zener, 12-V, 5-mA	VMD2	VDZT2R12B	Rohm
2	J1, J3		Terminal Block, 4-pin, 15-A, 5,1-mm	0.80 x 0.35	ED2227	OST
1	J2	PTC36SAAN	Header, 2-pin, 100-mil spacing (36-pin strip)	0.100 x 2	PTC36SAAN	Sullins
1	L1	33 μ H	Inductor, SMT, 3.2-A, 0.039- Ω	12,5 x 12,5 mm	SLF12575T330M3R2PF	TDK
1	PCB		2 Layer PCB 2-Ounce Cu	1.4 x 2.12 x 0.062	HPA164	Any
1	Q1	BSS83	Transistor, N-ch, 50-mA	SOT-143B	BSS83	Philips
1	Q2	FDC654P	Transistor, MOSFET, P-ch, -3.6-A, -30V, 0.075- Ω	SuperSOT-6	FDC654P	Fairchild
1	R1	10 Ω	Resistor, Chip, 1/16-W, 1%	603	Std	Std
1	R2	0.02 Ω	Resistor, Chip, 1/2-W, 5%	2010	Std	Std
1	R3	68.1 k Ω	Resistor, Chip, 1/16-W, 1%	603	Std	Std
1	R4	2 k Ω	Resistor, Chip, 1/16-W, 1%	603	Std	Std
1	R5	0 Ω	Resistor, Chip, 1/16-W, 1%	603	Std	Std
1	R6	26.7 k Ω	Resistor, Chip, 1/16-W, 1%	603	Std	Std
1	R7	1 k Ω	Resistor, Chip, 1/16-W, 1%	603	Std	Std
1	R8	300 k Ω	Resistor, Chip, 1/16-W, 1%	603	Std	Std
0	R9	OPEN				
1	R10	100 k Ω	Resistor, Chip, 1/16-W, 1%	603	Std	Std
1	R11	10 k Ω	Resistor, Chip, 1/16-W, 1%	603	Std	Std
1	R12	1 M Ω	Resistor, Chip, 1/16-W, 1%	603	Std	Std
1	R13	49.9 Ω	Resistor, Chip, 1/16-W, 1%	603	Std	Std
5	TP1, TP3, TP13, TP14, TP15	5002	Test Point, White, Thru Hole Color Keyed	0.1 x 0.1 in.	5002	Keystone
12	TP2, TP5, TP6, TP7, TP8, TP9, TP10, TP12, TP16, TP18, TP19, TP20	Std	Test Point, 0.020 Hole	0.1 x 0.1 in.	NA	NA
1	U1	TPS40200D	IC, Low-Cost Sync Buck Controller	SO-8	TPS40200D	TI

EVALUATION BOARD/KIT IMPORTANT NOTICE

Texas Instruments (TI) provides the enclosed product(s) under the following conditions:

This evaluation board/kit is intended for use for **ENGINEERING DEVELOPMENT, DEMONSTRATION, OR EVALUATION PURPOSES ONLY** and is not considered by TI to be a finished end-product fit for general consumer use. Persons handling the product(s) must have electronics training and observe good engineering practice standards. As such, the goods being provided are not intended to be complete in terms of required design-, marketing-, and/or manufacturing-related protective considerations, including product safety and environmental measures typically found in end products that incorporate such semiconductor components or circuit boards. This evaluation board/kit does not fall within the scope of the European Union directives regarding electromagnetic compatibility, restricted substances (RoHS), recycling (WEEE), FCC, CE or UL, and therefore may not meet the technical requirements of these directives or other related directives.

Should this evaluation board/kit not meet the specifications indicated in the User's Guide, the board/kit may be returned within 30 days from the date of delivery for a full refund. **THE FOREGOING WARRANTY IS THE EXCLUSIVE WARRANTY MADE BY SELLER TO BUYER AND IS IN LIEU OF ALL OTHER WARRANTIES, EXPRESSED, IMPLIED, OR STATUTORY, INCLUDING ANY WARRANTY OF MERCHANTABILITY OR FITNESS FOR ANY PARTICULAR PURPOSE.**

The user assumes all responsibility and liability for proper and safe handling of the goods. Further, the user indemnifies TI from all claims arising from the handling or use of the goods. Due to the open construction of the product, it is the user's responsibility to take any and all appropriate precautions with regard to electrostatic discharge.

EXCEPT TO THE EXTENT OF THE INDEMNITY SET FORTH ABOVE, NEITHER PARTY SHALL BE LIABLE TO THE OTHER FOR ANY INDIRECT, SPECIAL, INCIDENTAL, OR CONSEQUENTIAL DAMAGES.

TI currently deals with a variety of customers for products, and therefore our arrangement with the user **is not exclusive.**

TI assumes **no liability for applications assistance, customer product design, software performance, or infringement of patents or services described herein.**

Please read the User's Guide and, specifically, the Warnings and Restrictions notice in the User's Guide prior to handling the product. This notice contains important safety information about temperatures and voltages. For additional information on TI's environmental and/or safety programs, please contact the TI application engineer or visit www.ti.com/esh.

No license is granted under any patent right or other intellectual property right of TI covering or relating to any machine, process, or combination in which such TI products or services might be or are used.

FCC Warning

This evaluation board/kit is intended for use for **ENGINEERING DEVELOPMENT, DEMONSTRATION, OR EVALUATION PURPOSES ONLY** and is not considered by TI to be a finished end-product fit for general consumer use. It generates, uses, and can radiate radio frequency energy and has not been tested for compliance with the limits of computing devices pursuant to part 15 of FCC rules, which are designed to provide reasonable protection against radio frequency interference. Operation of this equipment in other environments may cause interference with radio communications, in which case the user at his own expense will be required to take whatever measures may be required to correct this interference.

EVM WARNINGS AND RESTRICTIONS

It is important to operate this EVM within the input voltage range of 0 V to 25 V and the output voltage range of 0 V to 6.3 V.

Exceeding the specified input range may cause unexpected operation and/or irreversible damage to the EVM. If there are questions concerning the input range, please contact a TI field representative prior to connecting the input power.

Applying loads outside of the specified output range may result in unintended operation and/or possible permanent damage to the EVM. Please consult the EVM User's Guide prior to connecting any load to the EVM output. If there is uncertainty as to the load specification, please contact a TI field representative.

During normal operation, some circuit components may have case temperatures greater than 100°C. The EVM is designed to operate properly with certain components above 100°C as long as the input and output ranges are maintained. These components include but are not limited to linear regulators, switching transistors, pass transistors, and current sense resistors. These types of devices can be identified using the EVM schematic located in the EVM User's Guide. When placing measurement probes near these devices during operation, please be aware that these devices may be very warm to the touch.

Mailing Address: Texas Instruments, Post Office Box 655303, Dallas, Texas 75265
Copyright © 2008, Texas Instruments Incorporated

IMPORTANT NOTICE

Texas Instruments Incorporated and its subsidiaries (TI) reserve the right to make corrections, modifications, enhancements, improvements, and other changes to its products and services at any time and to discontinue any product or service without notice. Customers should obtain the latest relevant information before placing orders and should verify that such information is current and complete. All products are sold subject to TI's terms and conditions of sale supplied at the time of order acknowledgment.

TI warrants performance of its hardware products to the specifications applicable at the time of sale in accordance with TI's standard warranty. Testing and other quality control techniques are used to the extent TI deems necessary to support this warranty. Except where mandated by government requirements, testing of all parameters of each product is not necessarily performed.

TI assumes no liability for applications assistance or customer product design. Customers are responsible for their products and applications using TI components. To minimize the risks associated with customer products and applications, customers should provide adequate design and operating safeguards.

TI does not warrant or represent that any license, either express or implied, is granted under any TI patent right, copyright, mask work right, or other TI intellectual property right relating to any combination, machine, or process in which TI products or services are used. Information published by TI regarding third-party products or services does not constitute a license from TI to use such products or services or a warranty or endorsement thereof. Use of such information may require a license from a third party under the patents or other intellectual property of the third party, or a license from TI under the patents or other intellectual property of TI.

Reproduction of TI information in TI data books or data sheets is permissible only if reproduction is without alteration and is accompanied by all associated warranties, conditions, limitations, and notices. Reproduction of this information with alteration is an unfair and deceptive business practice. TI is not responsible or liable for such altered documentation. Information of third parties may be subject to additional restrictions.

Resale of TI products or services with statements different from or beyond the parameters stated by TI for that product or service voids all express and any implied warranties for the associated TI product or service and is an unfair and deceptive business practice. TI is not responsible or liable for any such statements.

TI products are not authorized for use in safety-critical applications (such as life support) where a failure of the TI product would reasonably be expected to cause severe personal injury or death, unless officers of the parties have executed an agreement specifically governing such use. Buyers represent that they have all necessary expertise in the safety and regulatory ramifications of their applications, and acknowledge and agree that they are solely responsible for all legal, regulatory and safety-related requirements concerning their products and any use of TI products in such safety-critical applications, notwithstanding any applications-related information or support that may be provided by TI. Further, Buyers must fully indemnify TI and its representatives against any damages arising out of the use of TI products in such safety-critical applications.

TI products are neither designed nor intended for use in military/aerospace applications or environments unless the TI products are specifically designated by TI as military-grade or "enhanced plastic." Only products designated by TI as military-grade meet military specifications. Buyers acknowledge and agree that any such use of TI products which TI has not designated as military-grade is solely at the Buyer's risk, and that they are solely responsible for compliance with all legal and regulatory requirements in connection with such use.

TI products are neither designed nor intended for use in automotive applications or environments unless the specific TI products are designated by TI as compliant with ISO/TS 16949 requirements. Buyers acknowledge and agree that, if they use any non-designated products in automotive applications, TI will not be responsible for any failure to meet such requirements.

Following are URLs where you can obtain information on other Texas Instruments products and application solutions:

Products

Amplifiers	amplifier.ti.com
Data Converters	dataconverter.ti.com
DSP	dsp.ti.com
Clocks and Timers	www.ti.com/clocks
Interface	interface.ti.com
Logic	logic.ti.com
Power Mgmt	power.ti.com
Microcontrollers	microcontroller.ti.com
RFID	www.ti-rfid.com
RF/IF and ZigBee® Solutions	www.ti.com/lprf

Applications

Audio	www.ti.com/audio
Automotive	www.ti.com/automotive
Broadband	www.ti.com/broadband
Digital Control	www.ti.com/digitalcontrol
Medical	www.ti.com/medical
Military	www.ti.com/military
Optical Networking	www.ti.com/opticalnetwork
Security	www.ti.com/security
Telephony	www.ti.com/telephony
Video & Imaging	www.ti.com/video
Wireless	www.ti.com/wireless

Mailing Address: Texas Instruments, Post Office Box 655303, Dallas, Texas 75265
Copyright © 2008, Texas Instruments Incorporated