

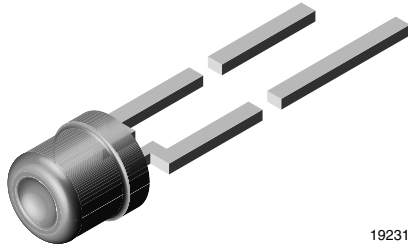

Backlighting LED in Ø 3 mm Tinted Non-Diffused Package



DESCRIPTION

The TLV.420. series was developed for backlighting. Due to its special shape the spatial distribution of the radiation is qualified for backlighting.

To optimize the brightness of backlighting a custom-built reflector (with scattering) is required. Uniform illumination can be enhanced by covering the front of the reflector with diffusor material.

This is a flexible solution for backlighting different areas.

PRODUCT GROUP AND PACKAGE DATA

- Product group: LED
- Package: 3 mm backlighting
- Product series: standard
- Angle of half intensity: $\pm 85^\circ$

FEATURES

- High light output
- Wide viewing angle
- Categorized for luminous flux
- Tinted clear package
- Low power dissipation
- Low self heating
- Rugged design
- High reliability
- Material categorization: for definitions of compliance please see www.vishay.com/doc?99912



APPLICATIONS

- Backlighting of display panels, LCD displays, symbols on switches, keyboards, graphic boards, and measuring scales
- Illumination of large areas e.g. dot matrix displays

PARTS TABLE														
PART	COLOR	LUMINOUS FLUX (mIm)			at I _F (mA)	WAVELENGTH (nm)			at I _F (mA)	FORWARD VOLTAGE (V)			at I _F (mA)	TECHNOLOGY
		MIN.	TYP.	MAX.		MIN.	TYP.	MAX.		MIN.	TYP.	MAX.		
TLVH4200 ⁽¹⁾	Red	10	55	-	15	612	-	625	10	-	2.4	3	20	GaAsP on GaP
TLVY4200	Yellow	10	30	-	15	581	-	594	10	-	2.4	3	20	GaAsP on GaP
TLVG4200	Green	10	30	-	15	562	-	575	10	-	2.4	3	20	GaP on GaP
TLVP4200 ⁽¹⁾	Pure green	4	20	-	15	555	-	565	10	-	2.4	3	20	GaP on GaP
TLVP4201 ⁽¹⁾	Pure green	16	30	-	15	555	-	565	10	-	2.4	3	20	GaP on GaP
TLVP4202	Pure green	6.3	30	-	15	555	-	565	10	-	2.4	3	20	GaP on GaP

Note

⁽¹⁾ Not for new designs

ABSOLUTE MAXIMUM RATINGS (T _{amb} = 25 °C, unless otherwise specified) TLVH4200, TLVY4200, TLVG4200, TLVP420.				
PARAMETER	TEST CONDITION	SYMBOL	VALUE	UNIT
Reverse voltage ⁽¹⁾		V _R	5	V
DC forward current	T _{amb} ≤ 60 °C	I _F	30	mA
Surge forward current	t _p ≤ 10 μs	I _{FSM}	1	A
Power dissipation		P _V	90	mW
Junction temperature		T _j	100	°C
Operating temperature range		T _{amb}	-40 to +100	°C
Storage temperature range		T _{stg}	-55 to +100	°C
Soldering temperature	t ≤ 5 s, 2 mm from body	T _{sd}	260	°C
Thermal resistance junction to ambient		R _{thJA}	400	K/W

Note

⁽¹⁾ Driving the LED in reverse direction is suitable for a short term application

**OPTICAL AND ELECTRICAL CHARACTERISTICS** ($T_{amb} = 25\text{ }^{\circ}\text{C}$, unless otherwise specified)
TLVH4200, RED

PARAMETER	TEST CONDITION	PART	SYMBOL	MIN.	TYP.	MAX.	UNIT
Luminous flux	$I_F = 15\text{ mA}$	TLVH4200 ⁽¹⁾	ϕ_V	10	55	-	mlm
Dominant wavelength	$I_F = 10\text{ mA}$		λ_d	612	-	625	nm
Peak wavelength	$I_F = 10\text{ mA}$		λ_p	-	635	-	nm
Angle of half intensity	$I_F = 10\text{ mA}$		φ	-	± 85	-	$^{\circ}$
Forward voltage	$I_F = 20\text{ mA}$		V_F	-	2.4	3	V
Reverse voltage	$I_R = 10\text{ }\mu\text{A}$		V_R	6	15	-	V
Junction capacitance	$V_R = 0\text{ V}$, $f = 1\text{ MHz}$		C_j	-	50	-	pF

Note⁽¹⁾ Not for new designs**OPTICAL AND ELECTRICAL CHARACTERISTICS** ($T_{amb} = 25\text{ }^{\circ}\text{C}$, unless otherwise specified)
TLVY4200, YELLOW

PARAMETER	TEST CONDITION	PART	SYMBOL	MIN.	TYP.	MAX.	UNIT
Luminous flux	$I_F = 15\text{ mA}$	TLVY4200	ϕ_V	10	30	-	mlm
Dominant wavelength	$I_F = 10\text{ mA}$		λ_d	581	-	594	nm
Peak wavelength	$I_F = 10\text{ mA}$		λ_p	-	585	-	nm
Angle of half intensity	$I_F = 10\text{ mA}$		φ	-	± 85	-	$^{\circ}$
Forward voltage	$I_F = 20\text{ mA}$		V_F	-	2.4	3	V
Reverse voltage	$I_R = 10\text{ }\mu\text{A}$		V_R	6	15	-	V
Junction capacitance	$V_R = 0\text{ V}$, $f = 1\text{ MHz}$		C_j	-	50	-	pF

OPTICAL AND ELECTRICAL CHARACTERISTICS ($T_{amb} = 25\text{ }^{\circ}\text{C}$, unless otherwise specified)
TLVG4200, GREEN

PARAMETER	TEST CONDITION	PART	SYMBOL	MIN.	TYP.	MAX.	UNIT
Luminous flux	$I_F = 15\text{ mA}$	TLVG4200	ϕ_V	10	30	-	mlm
Dominant wavelength	$I_F = 10\text{ mA}$		λ_d	562	-	575	nm
Peak wavelength	$I_F = 10\text{ mA}$		λ_p	-	555	-	nm
Angle of half intensity	$I_F = 10\text{ mA}$		φ	-	± 85	-	$^{\circ}$
Forward voltage	$I_F = 20\text{ mA}$		V_F	-	2.4	3	V
Reverse voltage	$I_R = 10\text{ }\mu\text{A}$		V_R	6	15	-	V
Junction capacitance	$V_R = 0\text{ V}$, $f = 1\text{ MHz}$		C_j	-	50	-	pF

OPTICAL AND ELECTRICAL CHARACTERISTICS ($T_{amb} = 25\text{ }^{\circ}\text{C}$, unless otherwise specified)
TLVP420., PURE GREEN

PARAMETER	TEST CONDITION	PART	SYMBOL	MIN.	TYP.	MAX.	UNIT
Luminous flux	$I_F = 15\text{ mA}$	TLVP4200 ⁽¹⁾	ϕ_V	4	20	-	mlm
		TLVP4201 ⁽¹⁾	ϕ_V	16	30	-	mlm
		TLVP4202	ϕ_V	6.3	30	-	mlm
Dominant wavelength	$I_F = 10\text{ mA}$		λ_d	555	-	565	nm
Peak wavelength	$I_F = 10\text{ mA}$		λ_p	-	555	-	nm
Angle of half intensity	$I_F = 10\text{ mA}$		φ	-	± 85	-	$^{\circ}$
Forward voltage	$I_F = 20\text{ mA}$		V_F	-	2.4	3	V
Reverse voltage	$I_R = 10\text{ }\mu\text{A}$		V_R	6	15	-	V
Junction capacitance	$V_R = 0\text{ V}$, $f = 1\text{ MHz}$		C_j	-	50	-	pF

Note⁽¹⁾ Not for new designs



LUMINOUS FLUX CLASSIFICATION		
GROUP	LUMINOUS FLUX (lm)	
STANDARD	MIN.	MAX.
P	4	8
Q	6.3	12.5
R	10	20
S	16	32
T	25	50
U	40	80
V	63	125
W	100	200
X	130	260
Y	180	360
Z	240	480

Note

- Luminous flux is tested at a current pulse duration of 25 ms.
The above type numbers represent the order groups which include only a few brightness groups. Only one group will be shipped on each bag (there will be no mixing of two groups in each bag).
In order to ensure availability, single brightness groups will not be orderable.
In a similar manner for colors where wavelength groups are measured and binned, single wavelength groups will be shipped on any one bag.
In order to ensure availability, single wavelength groups will not be orderable

COLOR CLASSIFICATION						
GROUP	DOM. WAVELENGTH (nm)					
	YELLOW		GREEN		PURE GREEN	
	MIN.	MAX.	MIN.	MAX.	MIN.	MAX.
0	-	-	-	-	555	559
1	581	584	-	-	558	561
2	583	586	-	-	560	563
3	585	588	562	565	562	565
4	587	590	564	567	-	-
5	589	592	566	569	-	-
6	591	594	568	571	-	-
7	-	-	570	573	-	-
8	-	-	572	575	-	-

Note

- Wavelengths are tested at a current pulse duration of 25 ms



TYPICAL CHARACTERISTICS (T_{amb} = 25 °C, unless otherwise specified)

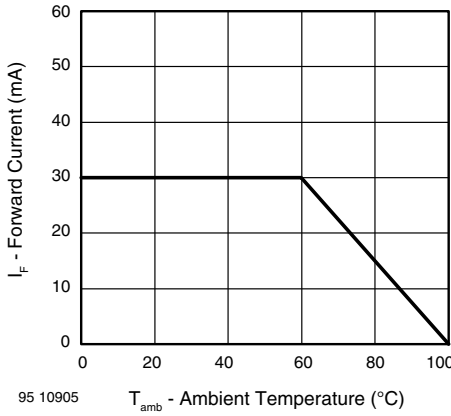

Fig. 1 - Forward Current vs. Ambient Temperature

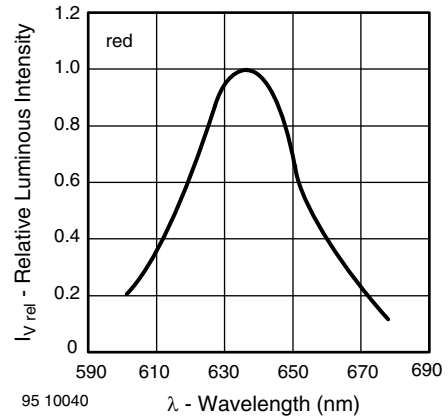

Fig. 4 - Relative Intensity vs. Wavelength

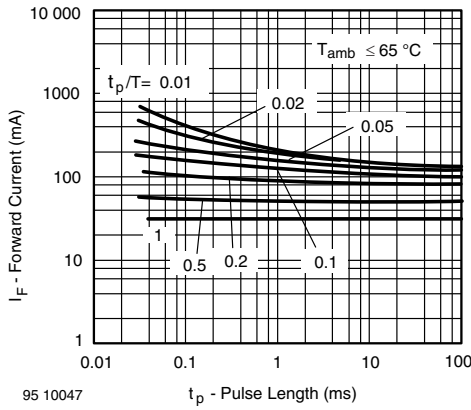

Fig. 2 - Forward Current vs. Pulse Length

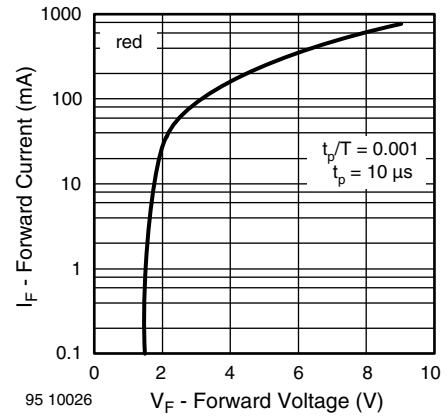

Fig. 5 - Forward Current vs. Forward Voltage

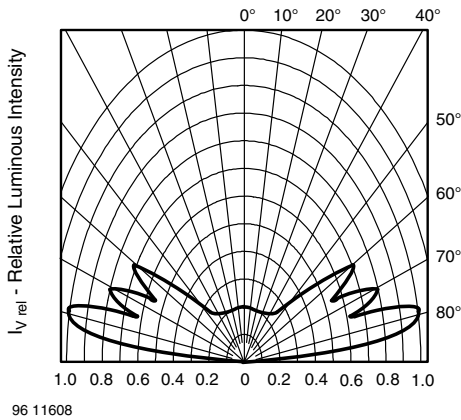

Fig. 3 - Relative Luminous Intensity vs. Angular Displacement for 90 ° Emission Angle

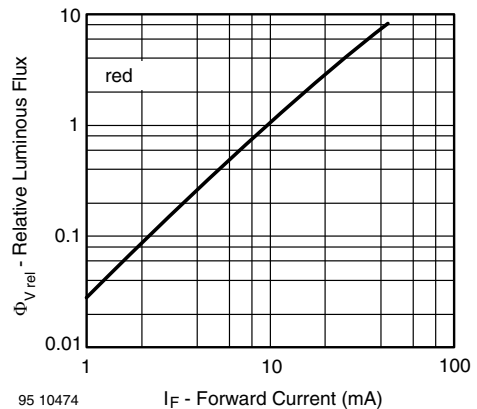

Fig. 6 - Relative Luminous Flux vs. Forward Current

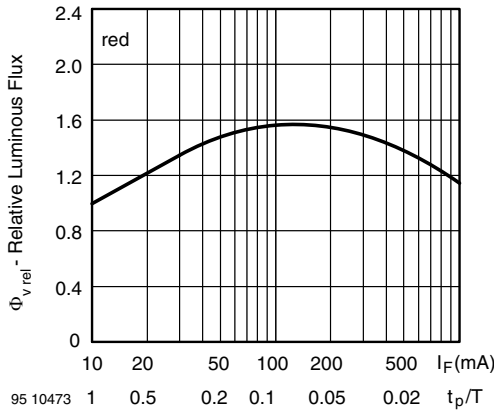

Fig. 7 - Relative Luminous Flux vs. Forward Current/Duty Cycle

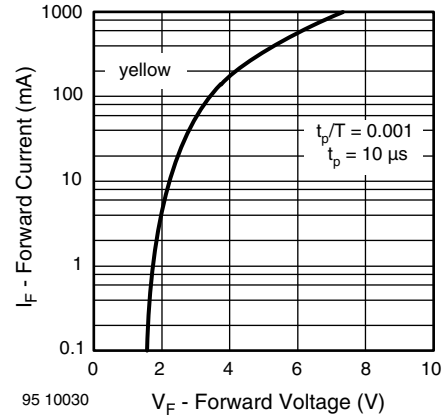

Fig. 10 - Forward Current vs. Forward Voltage

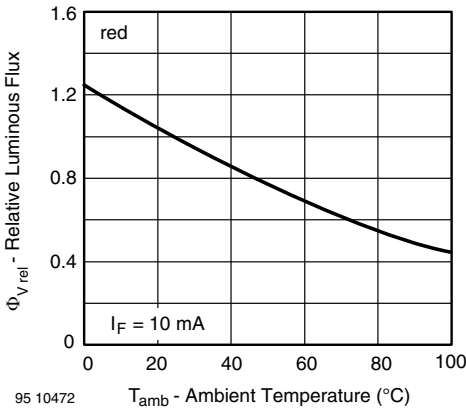

Fig. 8 - Relative Luminous Flux vs. Ambient Temperature

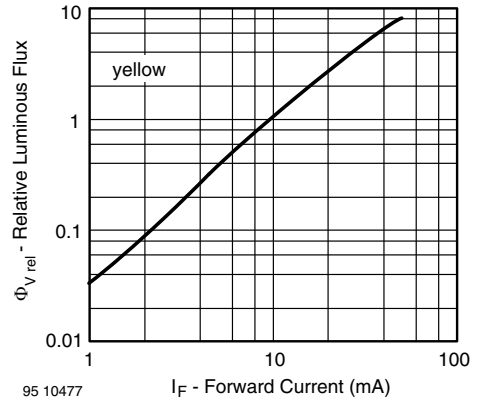

Fig. 11 - Relative Luminous Flux vs. Forward Current

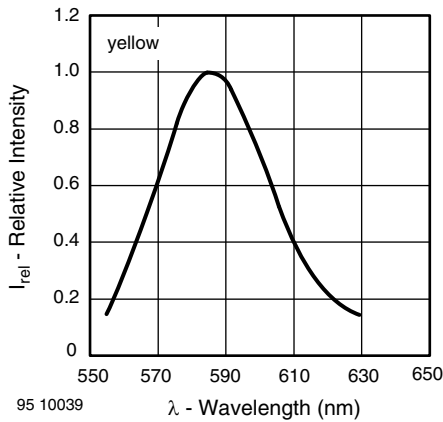

Fig. 9 - Relative Intensity vs. Wavelength

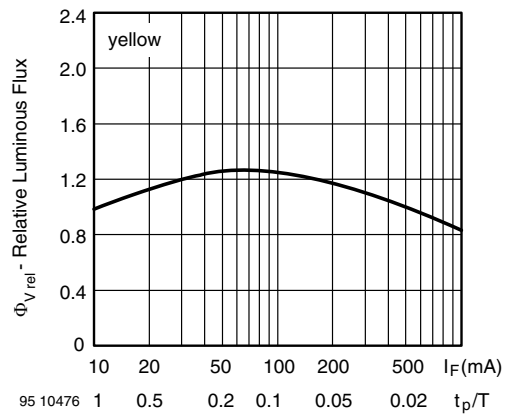

Fig. 12 - Relative Luminous Flux vs. Forward Current/Duty Cycle

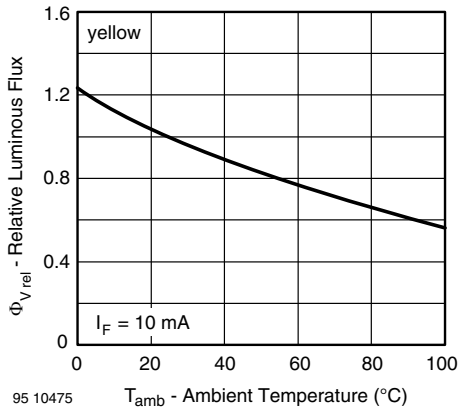

Fig. 13 - Relative Luminous Flux vs. Ambient Temperature

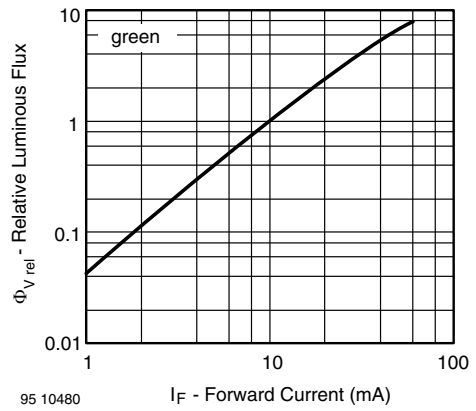

Fig. 16 - Relative Luminous Flux vs. Forward Current

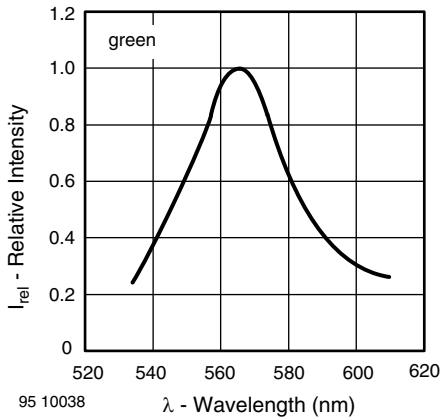

Fig. 14 - Relative Intensity vs. Wavelength

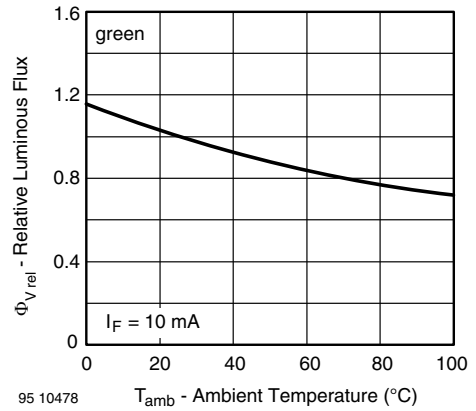

Fig. 17 - Relative Luminous Flux vs. Ambient Temperature

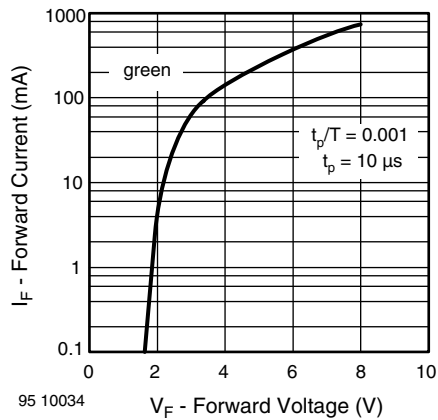

Fig. 15 - Forward Current vs. Forward Voltage

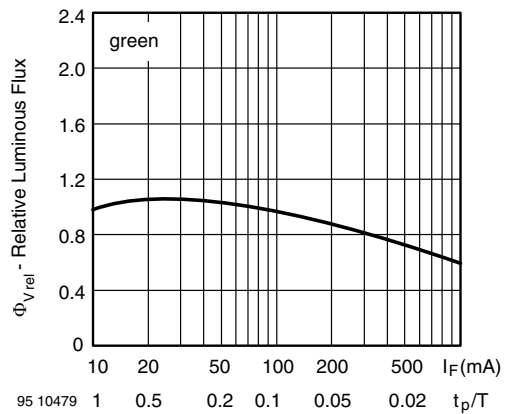

Fig. 18 - Relative Luminous Flux vs. Forward Current/Duty Cycle

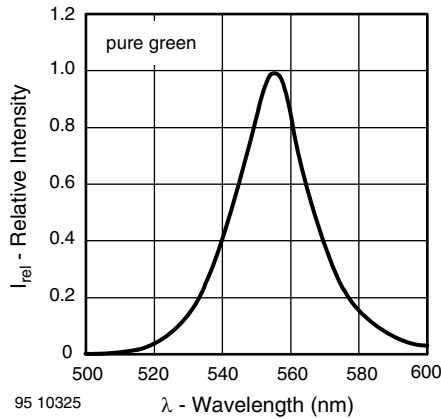

Fig. 19 - Relative Intensity vs. Wavelength

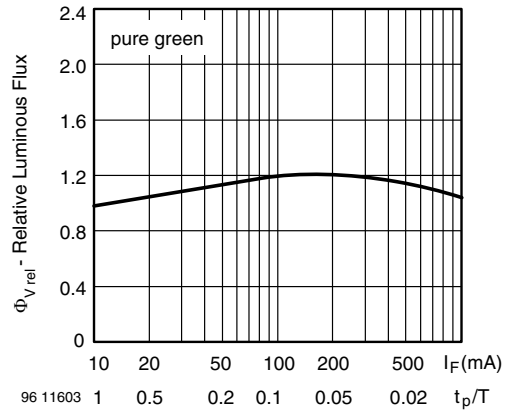

Fig. 22 - Relative Luminous Flux vs. Forward Current/Duty Cycle

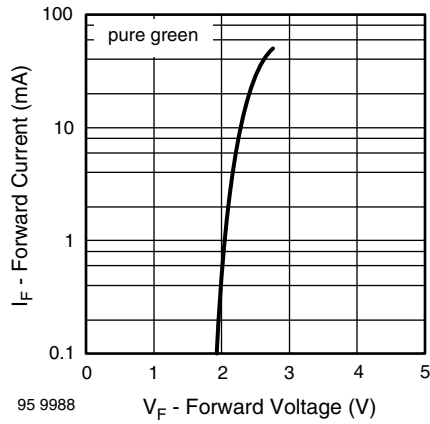

Fig. 20 - Forward Current vs. Forward Voltage

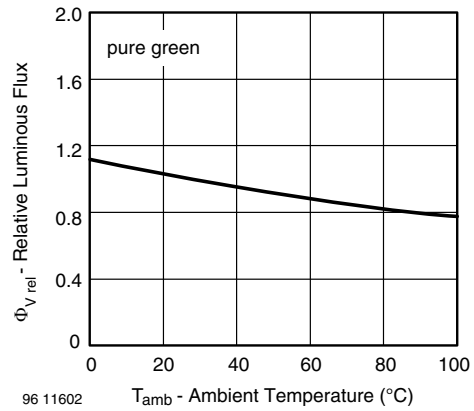

Fig. 23 - Relative Luminous Flux vs. Ambient Temperature

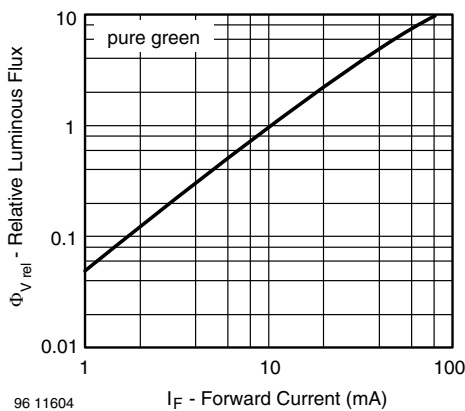
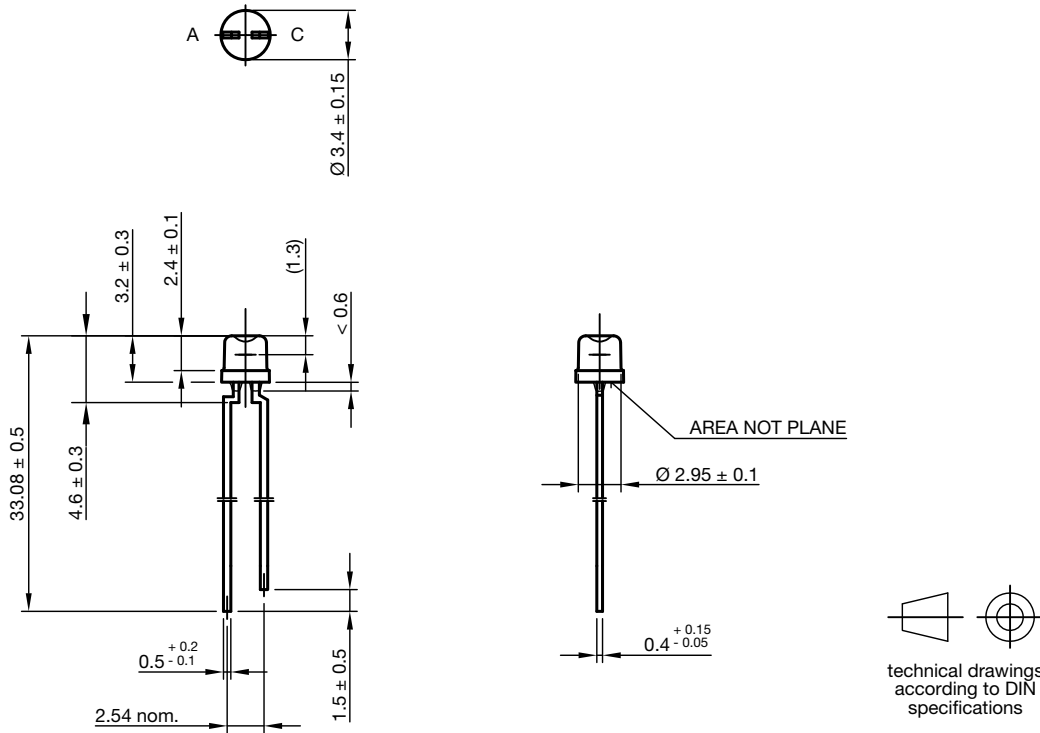

Fig. 21 - Relative Luminous Flux vs. Forward Current



PACKAGE DIMENSIONS in millimeters



Drawing-No.: 6.544-5268.01-4
Issue: 3; 28.07.14



Disclaimer

ALL PRODUCT, PRODUCT SPECIFICATIONS AND DATA ARE SUBJECT TO CHANGE WITHOUT NOTICE TO IMPROVE RELIABILITY, FUNCTION OR DESIGN OR OTHERWISE.

Vishay Intertechnology, Inc., its affiliates, agents, and employees, and all persons acting on its or their behalf (collectively, "Vishay"), disclaim any and all liability for any errors, inaccuracies or incompleteness contained in any datasheet or in any other disclosure relating to any product.

Vishay makes no warranty, representation or guarantee regarding the suitability of the products for any particular purpose or the continuing production of any product. To the maximum extent permitted by applicable law, Vishay disclaims (i) any and all liability arising out of the application or use of any product, (ii) any and all liability, including without limitation special, consequential or incidental damages, and (iii) any and all implied warranties, including warranties of fitness for particular purpose, non-infringement and merchantability.

Statements regarding the suitability of products for certain types of applications are based on Vishay's knowledge of typical requirements that are often placed on Vishay products in generic applications. Such statements are not binding statements about the suitability of products for a particular application. It is the customer's responsibility to validate that a particular product with the properties described in the product specification is suitable for use in a particular application. Parameters provided in datasheets and / or specifications may vary in different applications and performance may vary over time. All operating parameters, including typical parameters, must be validated for each customer application by the customer's technical experts. Product specifications do not expand or otherwise modify Vishay's terms and conditions of purchase, including but not limited to the warranty expressed therein.

Hyperlinks included in this datasheet may direct users to third-party websites. These links are provided as a convenience and for informational purposes only. Inclusion of these hyperlinks does not constitute an endorsement or an approval by Vishay of any of the products, services or opinions of the corporation, organization or individual associated with the third-party website. Vishay disclaims any and all liability and bears no responsibility for the accuracy, legality or content of the third-party website or for that of subsequent links.

Except as expressly indicated in writing, Vishay products are not designed for use in medical, life-saving, or life-sustaining applications or for any other application in which the failure of the Vishay product could result in personal injury or death. Customers using or selling Vishay products not expressly indicated for use in such applications do so at their own risk. Please contact authorized Vishay personnel to obtain written terms and conditions regarding products designed for such applications.

No license, express or implied, by estoppel or otherwise, to any intellectual property rights is granted by this document or by any conduct of Vishay. Product names and markings noted herein may be trademarks of their respective owners.