

MAX20446B Evaluation Kit

Evaluates: MAX20446B

General Description

The MAX20446B evaluation kit (EV kit) demonstrates the MAX20446B integrated 6-channel high-brightness (HB) LED driver with boost controller and I²C interface for automotive displays.

The EV kit operates from a DC supply voltage between 4.5V and 36V and the switching frequency can be set either at 2.2MHz or at 400kHz. The EV kit operates in I²C mode only. Spread-spectrum mode (SSM) is enabled by default for electromagnetic interference (EMI) improvement but can be disabled by acting on a register bit. The EV kit demonstrates phase-shifted pulse-width modulation (PWM) dimming. Dimming can be performed externally using a PWM signal applied to the DIM PCB pad or internally by programming the desired dimming frequency and individual duty cycle through I²C. The hybrid dimming feature can be enabled through a register bit to reduce EMI. The EV kit also demonstrates short-LED, open-LED, boost output undervoltage, as well as overvoltage- and overtemperature-fault protection.

For operation at switching frequencies other than 2.2MHz or 400kHz, the external components should be chosen according to the calculations in the MAX20446B IC data sheet.

The EV kit provides an I²C interface that can operate in conjunction with the Maxim command module (MINIUSB+) or a third-party I²C master. The EV kit also includes Windows®-compatible software that provides a simple graphical user interface (GUI) for exercising the features of the IC.

Features

- Demonstrates Robustness of MAX20446B
- Wide 4.5V to 36V Input Operating Range (Up to 52V Load Dump)
- Powers HB LEDs (Up to Six Strings) for Medium-to-Large-Sized LCD Displays in Automotive and Display Backlight Applications
- 400kHz to 2.2MHz Resistor-Programmable Switching Frequency with Spread-Spectrum Option
- Phase-Shift Dimming Option
- Demonstrates Cycle-by-Cycle Current Limit and Thermal-Shutdown Features
- Demonstrates Wide Dimming Ratio
- Demonstrates Fail-Safe Operation
- I²C Programmability
- Dedicated GUI
- Proven PCB Layout and Thermal Design
- Fully Assembled and Tested

MAX20446B EV Kit Files

FILE	DESCRIPTION
MAX20446BGUISetupV01.exe	Windows GUI Installer

[Ordering Information](#) appears at end of data sheet.

Windows is a registered trademark and registered service mark of Microsoft Corporation.

Quick Start

Required Equipment

- MAX20446B EV kit
- 5V to 36V, 4A DC power supply
- Two digital voltmeters (DVMs)
- Six series-connected HB LED strings (6 LEDs each) rated to no less than 120mA
- Current probe to measure the HB LED current
- MINIQUSB+ interface board with USB cable
- Windows-compatible PC with a spare USB port

Procedure

The EV kit is fully assembled and tested. Follow the steps to verify board operation.

Caution: Do not turn on the power supply until all connections are completed.

- 1) Visit www.maximintegrated.com to download the latest version of the EV kit software, MAX20446BGUISetupV01.exe, from the product's landing page.
- 2) Install the EV kit software (GUI) on your PC by running the MAX20446BGUISetupV01.exe program. The EV kit software application is installed together with the required MINIQUSB+ drivers.
- 3) Verify that jumper J17 is closed and that jumper J22 is open (2.2MHz switching frequency selected).
- 4) Verify that jumper J1 is closed (DS1 green LED connected).
- 5) Verify that jumper J23 is closed (FSEN function disabled).
- 6) Verify that jumper J20 is closed (FAULT signaling enabled).
- 7) Verify that a shunt is installed across pins 1-2 on jumper J2 (device enabled).
- 8) Verify that jumpers JMP1–JMP3, JMP6, JMP7, and JMP9 have shunts installed across pins 1-2 (bleed resistors connected, all current sinks enabled).
- 9) Connect the MINIQUSB+ interface board's P3 header to the J24 header on the EV kit.
- 10) Connect the positive terminal of the power supply to the IN PCB pad. Connect the negative terminal of the power supply to a PGND PCB pad.
- 11) Connect a DVM across the OUT1 and GND PCB pads.
- 12) Connect the six LED strings from VOUT to the OUT1, OUT2, OUT3, OUT4, OUT5, and OUT6 PCB pads.
- 13) Clip the current probe across the channel 1 HB LED+ wire to measure the LED current.
- 14) Turn on the power supply and set to 12V. The green LED (DS1) should be on at this point.
- 15) Launch the EV kit software application.
- 16) From the EV kit software toolbar, select Device → Scan for Address. The GUI scans the I²C bus for available slave addresses on the bus and selects the first one (in this case, the MAX20446B I²C address). Press OK once the MAX20446B I²C address has been found.
- 17) Verify that the status bar in the bottom-right corner of the GUI displays EV Kit: Connected, as shown in [Figure 1](#).
- 18) Select the desired OUT_ current value (45mA to 120mA in 5mA steps) in the 0x02 ISET register group box by acting on the ISET slider bar, then click the Refresh button.
- 19) Check ENA to activate the driver in the 0x02 ISET register group box.
- 20) Measure the voltage from each of the OUT_ PCB pads to PGND and verify the lowest voltage is approximately 1V.
- 21) Measure the LED current using the current probe and verify all channels.
- 22) For more details on how to use the GUI and all the features available, click on the GUI Help menu item.

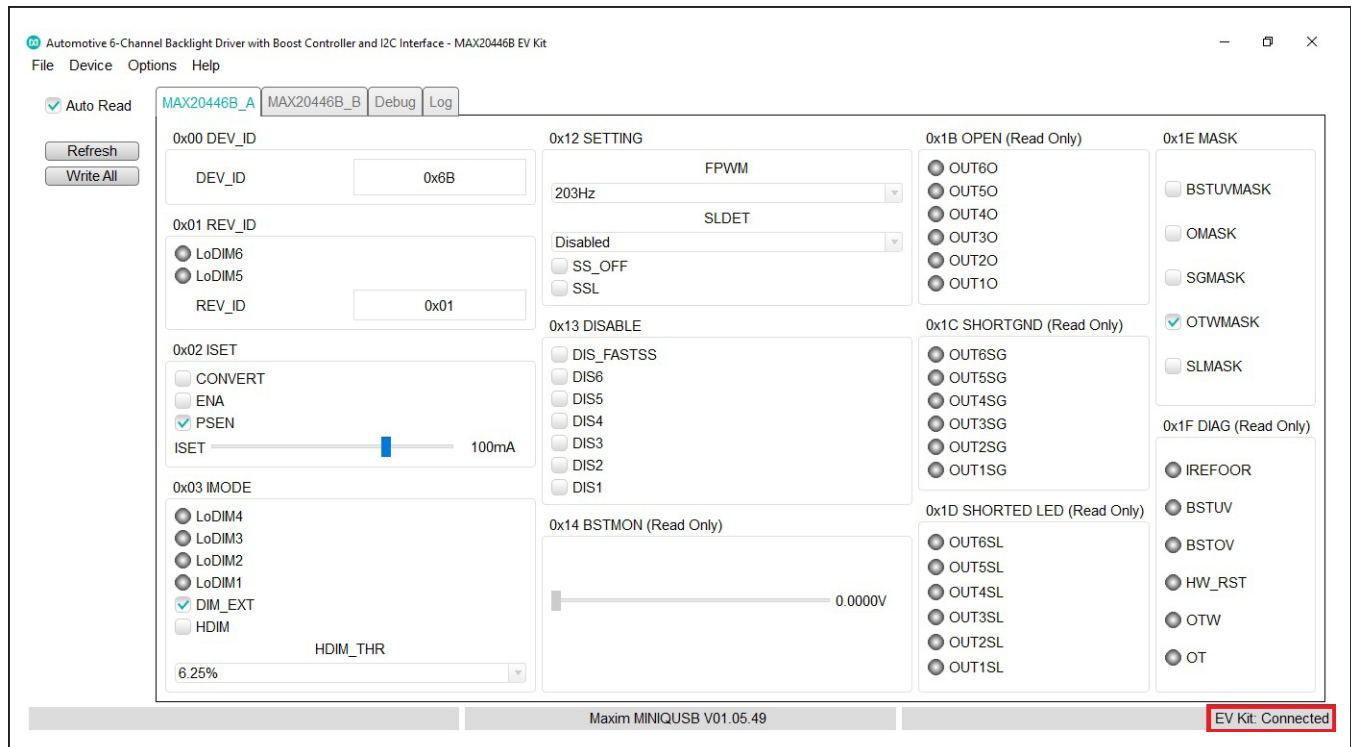

Figure 1. MAX20446B Evaluation Kit Software (GUI)

Detailed Description of Hardware

The MAX20446B EV kit demonstrates the MAX20446B HB LED driver with an integrated step-up DC-DC pre-regulator, followed by six linear current sinks to drive up to six strings of LEDs. The preregulator switches at 2.2MHz (or at 400kHz) and operates as a current-mode-controlled regulator, providing up to 720mA for the linear current sinks, as well as overvoltage protection. The cycle-by-cycle current limit is set by resistor R27, while resistors R4 and R5 set the overvoltage-protection voltage to 29V. The preregulator power section consists of inductor L2, power-sense resistor R27, MOSFET Q4, and switching-diode D1. The EV kit circuit operates from a 4.5V DC supply voltage up to the HB LED forward string voltage. The circuit handles load-dump conditions up to 50V.

The EV kit circuit demonstrates ultra-low shutdown current when the device's EN pin is pulled to ground by shorting the EN PCB pad to ground. Each of the six linear current sinks (OUT1–OUT6) is capable of operating up to 48V, sinking up to 120mA per channel.

Each of the six channels' linear current sinks is I²C-configurable for 45mA to 120mA in 5mA steps, or can be

disabled independently either by acting on **0x13 DISABLE** register group box or by acting on jumpers JMP1–JMP3, JMP6, JMP7, and JMP9 which are used to disable outputs selectively when the HB LED string is not connected. The EV kit features PCB pads to facilitate connecting HB LED strings for evaluation. The VOUT PCB pads provide connections for connecting each HB LED string's anode to the DC-DC preregulator output. The OUT1–OUT6 PCB pads provide connections for connecting each HB LED string's cathode to the respective current sink. Capacitors C11, C14, C18, C23, C24, and C25 are included on the design to prevent oscillations and provide stability when using long, untwisted HB LED connecting cables during lab evaluation. These capacitors are not required if the connection between the LED driver and the HB LEDs is a low-inductance connection.

A DIM PCB pad is provided for using a digital PWM signal to control the brightness of the HB LEDs. Test points are also provided for easy access to the device's V_{CC} regulator output, as well as the COMP pin and the switching node of the preregulator (LX).

SDA and SCL Voltages (J18, J19, and J21)

SDA and SCL voltage supplies can be selected between the V_{CC} voltage and the fixed 3.3V provided by the MINIUSB+. Alternatively, the user can force an external voltage as digital reference (see [Table 1](#)).

Power LED Enable (J1)

A green LED (DS1) is used to indicate that the EV kit is powered on. The LED can be disconnected from the power supply, allowing precise current-consumption evaluation. See [Table 2](#) for shunt positions.

Enable (EN)

The EV kit features an enable input that can be used to enable/disable the device and place it in shutdown mode. To enable the EV kit whenever power is applied to IN, place the jumper across pins 1-2 on jumper J2. To enable the EV kit using an external enable signal, place the jumper across pins 2-3 on J2 and apply a logic signal on the EN PCB input pad on the EV kit. A 1MΩ pulldown resistor on the EV kit pulls the EN input to ground in the event that JU15 is left open or the EN signal is high impedance. Refer to the *Enable* section in the MAX20446B IC data sheet for additional information. See [Table 3](#) for J2 jumper settings.

Table 1. SDA and SCL Supply (J18, J19, and J21)

SHUNT POSITION			SDA AND SCL SUPPLY
J18	J19	J21	
Open*	Open*	Open*	3.3V (with MINIUSB+ connected)
Closed	Closed	Open	V _{CC}
Open	Open	1-2	Externally provided

*Default position.

Table 2. DS1 Enable (J1)

SHUNT POSITION	DS1 POWER LED
Closed*	Connected
Open	Disconnected

*Default position.

Switching Frequency

Jumpers J17 and J22 are used to set the switching frequency of the MAX20446B to 2.2MHz or 400kHz. When J17 is closed and J22 is open, the switching frequency is set to 2.2MHz. When J17 is open and J22 is closed, the switching frequency is nominally 400kHz (see [Table 4](#)).

The EV kit is optimized for 2.2MHz switching operation by default. When selecting a switching frequency of 400kHz, L2 should be changed to 22μH to maintain acceptable efficiency. Other component-value adjustments may be needed.

The spread-spectrum feature can be enabled/disabled by checking/unchecking **SS_OFF** in the **0x12 SETTING** register group box. With spread-spectrum enabled, it is also possible to select the amount of spread by checking (±3%)/unchecking (±6%) **SSL** in the **0x12 SETTING** register group box.

Refer to the *Oscillator Frequency/External Synchronization* and *Spread-Spectrum Mode* sections in the MAX20446B IC data sheet for more information.

Table 3. Enable (J2)

SHUNT POSITION	EN PIN	EV KIT OPERATION
1-2*	Connected to IN	Enabled when IN is powered
2-3	Connected to EN PCB pad	Enabled/disabled by signal on EN PCB pad

*Default position.

Table 4. Switching Frequency (J17 and J22)

SHUNT POSITION		RT PIN	EV KIT OPERATION
J17	J22		
Closed*	Open*	RT connected to GND through 13.3kΩ resistor	2.2MHz switching frequency
Open	Closed	RT connected to GND through 76.8kΩ resistor	400kHz switching frequency

*Default position.

HB LED Current

The device’s current sinks’ current on all six channels is fully configurable through I²C (**ISET** slider bar in the **0x02 ISET** register group box). No direct action on the EV kit is needed.

Channel 1–Channel 6 Current-Sink Disabling

The EV kit features jumpers JMP1–JMP3, JMP6, JMP7, and JMP9 which are used to put each OUT_ current sink in one of three operating states:

- 1) Normal operation: OUT_ connected to the corresponding ring on the board edge, with LEDs connected from there to the preregulator output (VOUT).

- 2) OUT_ connected through a 12kΩ resistor to GND and thus disabled.
 - 3) OUT_ shorted to GND, used to test fault detection.
- To disable a channel, install a shunt in the channel’s respective jumper across pins 1–3, connecting the OUT_ to ground through a 12kΩ resistor. The dimming algorithm in the IC requires that higher numbered OUT_ current sinks be disabled first (e.g., if only two strings are needed, OUT1/OUT2 should be used, with OUT3–OUT6 disabled). See [Table 5](#) for jumper settings. The 100kΩ bleed resistors are installed to prevent the OUT_ leakage current from dimly turning on large LED strings even when the DIM signal is low. Note that each channel can be alternatively disabled through I²C by acting on **0x13 DISABLE** register group box.

Table 5. Selecting OUT_ Channel Operating State (JMP1–JMP3, JMP6, JMP7, and JMP9)

OUT_	JUMPER	SHUNT POSITION	CHANNEL OPERATION
OUT1	JMP9	1-2*	Channel 1 operational. Connect an HB LED string** between VOUT and OUT1. Bleed resistor connected.
		1-3	Channel 1 not used. OUT1 current sink disabled.
		1-4	Channel 1 shorted to GND to simulate a fault.
OUT2	JMP7	1-2*	Channel 2 operational. Connect an HB LED string** between VOUT and OUT2. Bleed resistor connected.
		1-3	Channel 2 not used. OUT2 current sink disabled.
		1-4	Channel 2 shorted to GND to simulate a fault.
OUT3	JMP6	1-2*	Channel 3 operational. Connect an HB LED string** between VOUT and OUT3. Bleed resistor connected.
		1-3	Channel 3 not used. OUT3 current sink disabled.
		1-4	Channel 3 shorted to GND to simulate a fault.
OUT4	JMP3	1-2*	Channel 4 operational. Connect an HB LED string** between VOUT and OUT4. Bleed resistor connected.
		1-3	Channel 4 not used. OUT4 current sink disabled.
		1-4	Channel 4 shorted to GND to simulate a fault.
OUT5	JMP2	1-2*	Channel 5 operational. Connect an HB LED string** between VOUT and OUT5. Bleed resistor connected.
		1-3	Channel 5 not used. OUT5 current sink disabled.
		1-4	Channel 5 shorted to GND to simulate a fault.
OUT6	JMP1	1-2*	Channel 6 operational. Connect an HB LED string** between VOUT and OUT6. Bleed resistor connected.
		1-3	Channel 6 not used. OUT6 current sink disabled.
		1-4	Channel 6 shorted to GND to simulate a fault.

*Default position.

**The series-connected HB LED string must be rated to no less than 120mA.

HB LED Digital Dimming Control

The EV kit features a DIM PCB input pad for connecting an external digital PWM signal. Apply a digital PWM signal with a $\leq 0.8V$ logic-low level and $\geq 2.1V$ logic-high level. The DIM signal frequency should be at least 100Hz. If the DIM frequency is changed during operation, the MAX20446B must be powered off and on again to register the change. To adjust the HB LED brightness, vary the signal duty cycle from 0% to 100% and maintain a minimum pulse width of 500ns. Apply the digital PWM signal to the DIM PCB pad. The DIM input of the IC is pulled up internally with a 5 μ A (typ) current source.

Dimming can also be performed by programming the desired dimming level through I²C. External dimming is enabled by default at each device's power-up. To disable it, first uncheck **DIM_EXT** in the **0x03 IMODE** register group box, then select one of the available dimming frequencies in the **FPWM** section in the **0x12 SETTING** register group box. Individual channel brightness levels can finally be selected by acting on the **TON1–TON6** slider bars.

Note: To ensure that correct brightness levels are selected in internal dimming mode, each **TON_** slider bar must be zeroed at each device's power-up.

For additional information on the device's digital dimming feature, refer to the *Dimming* section in the MAX20446B IC data sheet.

Hybrid dimming Operation

The hybrid dimming feature can be used both with external and internal dimming. The device determines whether the LED current must be dimmed by reducing the LED current or by chopping the LED current (depending on the hybrid dimming threshold set in the **HDIM_THR** section in

the **0x03 IMODE** register group box). To enable the hybrid dimming feature, check **HDIM** in the **0x03 IMODE** register group box.

For additional information on the device's hybrid dimming feature, refer to the *Hybrid Dimming* section in the MAX20446B IC data sheet.

Phase-Shift Operation

The EV kit demonstrates the phase-shifting feature of the IC. Phase-shift is enabled by default at each device's power-up. To disable it, uncheck **PSEN** in the **0x02 ISET** register group box. This operation must always be performed before enabling any LED string.

When phase shifting is enabled, each current sink's turn-on is separated by 360°/n, where n is the number of enabled strings. When phase shifting is disabled, the dimming of each string is controlled by the DIM input (or by the **FPWM** and **TON_** settings if internal dimming is enabled), and all current sinks turn on and off at the same time.

Fail-Safe Operation

The EV kit demonstrates the fail-safe feature of the IC. One of the jumpers (J3–J6, J8, J10, J12, J14) can be closed before powering up the device to select, through a resistor to ground, the current level to which the current sinks are enabled in case the FSEN PCB pad is connected to V_{CC} (even if **ENA** bit is not checked). If jumper J23 is closed, FSEN is shorted to ground and its function is disabled. Only one jumper at a time must be closed. See [Table 6](#) for jumper settings.

For additional information on the device's fail-safe operation, refer to the *FSEN Pin Function* section in the MAX20446B IC data sheet.

Table 6. Selecting FSEN Resistor (J3–J6, J8, J10, J12, J14, and J23)

FSEN RESISTOR VALUE (k Ω)	JUMPER	SHUNT POSITION	OUT_ CURRENT (mA)
0 (FSEN shorted to GND)*	J23	Closed	Fail-safe disabled
3.48	J14	Closed	25
7.15	J12	Closed	25
12	J10	Closed	50
18.7	J8	Closed	50
27.4	J6	Closed	75
39	J5	Closed	75
59	J4	Closed	100
84.5	J3	Closed	100

*Default position.

Fault-Indicator Output ($\overline{\text{FLT}}$)

The EV kit features the device’s open-drain $\overline{\text{FLT}}$ output. The $\overline{\text{FLT}}$ signal is pulled up to V_{CC} by resistor R48. $\overline{\text{FLT}}$ goes low when an open-LED or shorted-LED string is detected during thermal warning/shutdown or during boost undervoltage/overvoltage events. Keep jumper J20 closed to allow DS2 red LED enabling in case $\overline{\text{FLT}}$ goes low. Refer to the *Fault Protection* section in the MAX20446B IC data sheet for additional information on the $\overline{\text{FLT}}$ signal.

Shorted-LED Detection and Protection

The short-LED threshold is set through I²C in the **SLDET** section in the **0x12 SETTING** register group box. A shorted LED is detected when the following condition is satisfied:

$$V_{\text{OUT}_{1-6}} > V_{\text{SLDET}}$$

When the short-LED threshold is reached, the affected current sink is disabled to reduce excess power dissipation and the $\overline{\text{FLT}}$ indicator asserts low.

Ordering Information

PART	TYPE
MAX20446BEVKIT#	EV Kit

#Denotes RoHS compliance.

Overvoltage Detection and Protection

The resistors (R4 and R5) connected to BSTMON are configured for a $V_{\text{OUT_OVP}}$ of 29V. This sets the maximum converter output (V_{OUT}) voltage at 29V. During an open-LED string condition, the converter output ramps up to the output overvoltage threshold. Capacitor C3 can be added to provide noise filtering to the overvoltage signal. To reconfigure the circuit for a different voltage, replace resistor R4 with a different value using the following equation:

$$R4 = [(V_{\text{OUT_OVP}}/1.23) - 1] \times R5$$

where R5 is 10k Ω , $V_{\text{OUT_OVP}}$ is the overvoltage-protection threshold desired, and R4 is the new resistor value for obtaining the desired overvoltage protection. MOSFET Q1 is an optional overvoltage-protection resistor-divider disconnect switch for ultra-low shutdown current. Refer to the *Open-LED Management and Overvoltage Protection* section in the MAX20446B IC data sheet for additional information.

MAX20446B EV Kit Bill of Materials

ITEM	REF_DES	DN/DNP	QTY	MFG PART #	MANUFACTURER	VALUE	DESCRIPTION
1	C2, C6, C16	-	3	UMK107BJ105KA; C1608X5R1H105K080AB; CL10A105KB8NNN; GRM188R61H105KAAL	TAIYO YUDEN;TDK; SAMSUNG;MURATA	1UF	CAPACITOR; SMT (0603); CERAMIC CHIP; 1UF; 50V; TOL=10%; MODEL=_MK SERIES; TG=-55 DEGC TO +85 DEGC
2	C4	-	1	C1608X7S2A104K080AB	TDK	0.1UF	CAPACITOR; SMT (0603); CERAMIC CHIP; 0.1UF; 100V; TOL=10%; TG=-55 DEGC TO +125 DEGC; TC=X7S
3	C5, C26, C31	-	3	C1210C475K5RAC; GRM32ER71H475KA88; GCM32ER71H475KA55; CGA6P3X7R1H475K250AB; UMK325B7475KMHP; CNC6P1X7R1H475K250AE	KEMET;MURATA;MURATA; TDK;TAIYO YUDEN;TDK	4.7UF	CAPACITOR; SMT (1210); CERAMIC CHIP; 4.7UF; 50V; TOL=10%; TG=-55 DEGC TO +125 DEGC; TC=X7R
4	C9, C10	-	2	EEE-TG1H470UP	PANASONIC	47UF	CAPACITOR; SMT (CASE_F); ALUMINUM-ELECTROLYTIC; 47UF; 50V; TOL=20%; MODEL=TG SERIES; TG=-40 DEGC TO +125 DEGC
5	C11, C12, C14, C18, C23-C25	-	7	GRM1885C1H102JA01; C1608C0G1H102J080AA; GCM1885C1H102JA16	MURATA;TDK;MURATA	1000PF	CAPACITOR; SMT (0603); CERAMIC CHIP; 1000PF; 50V; TOL=5%; TG=-55 DEGC TO +125 DEGC
6	C13	-	1	C0603C473K5RAC; GRM188R71H473KA61; GCM188R71H473KA55; CGA3E2X7R1H473K080AA	KEMET;MURATA;MURATA;TDK	0.047UF	CAPACITOR; SMT (0603); CERAMIC CHIP; 0.047UF; 50V; TOL=10%; MODEL=X7R; TG=-55 DEGC TO +125 DEGC; TC=X7R
7	C17	-	1	C1608C0G1H100D080AA	TDK	10PF	CAPACITOR; SMT (0603); CERAMIC CHIP; 10PF; 50V; TOL=0.5PF; TG=-55 DEGC TO +125 DEGC; TC=C0G
8	C20	-	1	GRM188R71A225KE15; CL10B225KP8NNN; C1608X7R1A225K080AC; C0603C225K8RAC	MURATA;SAMSUNG;TDK;KEMET	2.2UF	CAPACITOR; SMT (0603); CERAMIC CHIP; 2.2UF; 10V; TOL=10%; TG=-55 DEGC TO +125 DEGC; TC=X7R
9	C21	-	1	GRM1885C1H222JA01	MURATA	2200PF	CAPACITOR; SMT (0603); CERAMIC; 2200PF; 50V; TOL=5%; TG=-55 DEGC TO +125 DEGC; TC=C0G
10	C22	-	1	C0603C683J5RAC; C0603X683J5RAC	KEMET;KEMET	0.068UF	CAPACITOR; SMT; 0603; CERAMIC; 0.068UF; 50V; 5%; X7R; -55degC to + 125degC; 0 +/-15% degC MAX.
11	C27	-	1	06035C101JAT	AVX	100PF	CAPACITOR; SMT (0603); CERAMIC CHIP; 100PF; 50V; TOL=5%; TG=-55 DEGC TO +125 DEGC; TC=X7R
12	C28	-	1	06035C220JAT	AVX	22PF	CAPACITOR; SMT (0603); CERAMIC CHIP; 22PF; 50V; TOL=5%; TG=-55 DEGC TO +125 DEGC; TC=X7R
13	C226	-	1	C2012X7R1H225K125AC	TDK	2.2UF	CAPACITOR; SMT (0805); CERAMIC CHIP; 2.2UF; 50V; TOL=10%; TG=-55 DEGC TO +125 DEGC; TC=X7R
14	COMP, LX, TP1, TP2, VCC	-	5	5011	KEYSTONE	N/A	TEST POINT; PIN DIA=0.125IN; TOTAL LENGTH=0.445IN; BOARD HOLE=0.063IN; BLACK; PHOSPHOR BRONZE WIRE SILVER PLATE FINISH;
15	D1	-	1	NRVBS260T3G	ON SEMICONDUCTOR	NRVBS260T3G	DIODE; SCH; SURFACE MOUNT SCHOTTKY POWER RECTIFIER; SMB; PIV=60V; IF=2A
16	D2, D3	-	2	BZG03C18	VISHAY SEMICONDUCTORS	18V	DIODE; ZNR; SMT (DO-214AC); VZ=18V; IZM=0.025A
17	D4	-	1	B160B-13-F	DIODES INCORPORATED	B160B-13-F	DIODE; SCH; SMB (DO-214AA); PIV=60V; IF=1A
18	D5	-	1	CMPD914E	CENTRAL SEMICONDUCTOR	CMPD914E	DIODE; SWT; SMT (SOT23-3); PIV=150V; IF=0.1A
19	DIM, EN, FLT, FSEN, GND, GND1, GND2, IN, OUT1-OUT6, PGND, PGND1, PGND2, SCL, SDA, SYNC, VOUT, VOUT1-VOUT3	-	24	9020 BUSS	WEICO WIRE	MAXIMPAD	EVK KIT PARTS; MAXIM PAD; WIRE; NATURAL; SOLID; WEICO WIRE; SOFT DRAWN BUS TYPE-S; 20AWG
20	DS1	-	1	LGL29K-F2J1-24-Z	OSRAM	LGL29K-F2J1-24-Z	DIODE; LED; SMARTLED; GREEN; SMT; PIV=1.7V; IF=0.02A
21	DS2	-	1	LS L29K-G1J2-1-Z	OSRAM	LS L29K-G1J2-1-Z	DIODE; LED; SMART; RED; SMT (0603); PIV=1.8V; IF=0.02A; -40 DEGC TO +100 DEGC
22	J1, J3-J6, J8, J10, J12, J14, J17-J20, J22, J23	-	15	PBC02SAAN	SULLINS ELECTRONICS CORP.	PBC02SAAN	CONNECTOR; MALE; THROUGH HOLE; BREAKAWAY; STRAIGHT; 2PINS

MAX20446B EV Kit Bill of Materials (continued)

ITEM	REF_DES	DN/DNP	QTY	MFG PART #	MANUFACTURER	VALUE	DESCRIPTION
23	J2, J21	-	2	PEC03SAAN	SULLINS ELECTRONICS CORP.	PEC03SAAN	EVKIT PART-CONNECTOR; MALE; THROUGH HOLE; BREAKAWAY; STRAIGHT; 3PINS; -65 DEGC TO +125 DEGC;
24	J24	-	1	803-87-020-20-001101	PRECI-DIP SA	803-87-020-20-001101	EVKIT PART-CONNECTOR; FEMALE; TH; DOUBLE ROW; 2.54MM; RIGHT ANGLE SOLDER TAIL; MATING PIN DIA 0.76MM; RIGHT ANGLE; 20PINS;
25	J25	-	1	HTSW-112-11-G-S-RA	SAMTEC	HTSW-112-11-G-S-RA	CONNECTOR; MALE; THROUGH HOLE; SQUARE POST HEADER; RIGHT ANGLE; 12PINS ;
26	JMP1-JMP3, JMP6, JMP7, JMP9	-	6	PEC04SAAN	SULLINS ELECTRONICS CORP.	PEC04SAAN	CONNECTOR; MALE; THROUGH HOLE; BREAKAWAY; STRAIGHT; 4PINS
27	L1	-	1	XAL4020-601ME	COILCRAFT	0.60UH	INDUCTOR; SMT; CORE MATERIAL= COMPOSITE; 0.60UH; TOL=+/-20%; 11.7A
28	L2	-	1	MSS1246T-472ML	COILCRAFT	4.7UH	INDUCTOR; SMT; FERRITE CORE; 4.7UH; TOL=+/-20%; 9.70A
29	Q1	-	1	NDS351AN	FAIRCHILD SEMICONDUCTOR	NDS351AN	TRAN; N-CHANNEL LOGIC LEVEL ENHANCEMENT MODE FIELD EFFECT TRANSISTOR; NCH; SUPERSOT-3; PD-(0.5W); I-(1.4A); V-(30V)
30	Q2	-	1	MMBT3906-7-F	DIODES INCORPORATED	MMBT3906-7-F	TRAN; 40V PNP SMALL SIGNAL TRANSISTOR; PNP; SOT-23; PD-(0.31W); I(- 0.2A); V(-40V)
31	Q3	-	1	SUM55P06-19L-E3	VISHAY SILICONIX	SUM55P06-19L-E3	TRAN; P-CHANNEL 60V D-S ENHANCEMENT MODE MOSFET; PCH; TO-263-3; PD-(3.75W); I(-55A); V(-60V)
32	Q4	-	1	NVMFS5826NLT1G	ON SEMICONDUCTOR	NVMFS5826NLT1G	TRAN; POWER MOSFET; SINGLE N-CHANNEL; NCH; SO-8FL; PD-(39W); I-(26A); V-(60V)
33	Q5	-	1	SI1317DL-T1-GE3	VISHAY SILICONIX	SI1317DL-T1-GE3	TRAN; P-CHANNEL 20V (D-S) MOSFET; PCH; SOT-323; PD-(0.5W); I(-1.4A); V(-20V)
34	R2	-	1	CRCW06033K00FK	VISHAY DALE	3K	RESISTOR; 0603; 3K OHM; 1%; 100PPM; 0.10W; THICK FILM
35	R3, R7	-	2	CRCW08050000ZS; RC2012J000	DIGI-KEY	0	RESISTOR; 0805; 0 OHM; JUMPER; 0.125W; THICK FILM
36	R4	-	1	CRCW0805226KFK	VISHAY DALE	226K	RESISTOR; 0805; 226K OHM; 1%; 100PPM; 0.125W; THICK FILM
37	R5	-	1	TNPW080510K0BE; ERA-6YEB103V	VISHAY DALE;PANASONIC	10K	RESISTOR; 0805; 10K OHM; 0.1%; 25PPM; 0.125W; THIN FILM
38	R6	-	1	301-10K-RC	XICON	10K	RESISTOR; 0603; 10K OHM; 5%, 200PPM, 1/16W, THICK FILM
39	R8	-	1	CRCW12060000ZS; ERJ-8GEY0R00	VISHAY DALE;PANASONIC	0	RESISTOR; 1206; 0 OHM; 0%; JUMPER; 0.25W; THICK FILM
40	R9	-	1	CRCW06031M00FK; MCR03EZPFX1004	VISHAY DALE;ROHM	1M	RESISTOR; 0603; 1M OHM; 1%, 100PPM, 0.10W, THICK FILM
41	R10, R17, R23, R34, R37, R43	-	6	CRCW0603100KFK; RC0603FR-07100KL; RC0603FR-13100KL; ERJ-3EKF1003; AC0603FR-07100KL	VISHAY DALE;YAGEO; YAGEO;PANASONIC	100K	RESISTOR; 0603; 100K; 1%; 100PPM; 0.10W; THICK FILM
42	R11	-	1	CRCW060318K0FK	VISHAY DALE	18K	RESISTOR; 0603; 18K OHM; 1%, 100PPM, 0.10W, THICK FILM
43	R12, R19, R22, R29, R36, R38, R45	-	7	CRCW060312K0FK	VISHAY DALE	12K	RESISTOR; 0603; 12K OHM; 1%, 100PPM, 0.10W, THICK FILM
44	R13	-	1	RC0603FR-0784K5L	YAGEO PHYCOMP	84.5K	RESISTOR; 0603; 84.5K OHM; 1%; 100PPM; 0.10W; THICK FILM
45	R14	-	1	ERJ-8CWFR050	PANASONIC	0.05	RESISTOR; 1206; 0.05 OHM; 1%; 75PPM; 1W; THICK FILM
46	R15, R49	-	2	RG1608N-102-B-T1	SUSUMU CO LTD.	1K	RESISTOR; 0603; 1K OHM; 0.1%; 10PPM; 0.10W; THICK FILM
47	R16	-	1	ERJ-3EKF5902	PANASONIC	59K	RESISTOR; 0603; 59K OHM; 1%; 100PPM; 0.1W; THICK FILM
48	R18	-	1	CRCW060327K4FK; ERJ-3EKF2742	VISHAY DALE;PANASONIC	27.4K	RESISTOR; 0603; 27.4K; 1%; 100PPM; 0.10W; THICK FILM
49	R20	-	1	ERJ-3EKF1872; CRCW060318K7FK	PANASONIC;VISHAY	18.7K	RESISTOR; 0603; 18.7K OHM; 1%; 100PPM; 0.10W; THICK FILM
50	R24	-	1	CRCW06033K74FK	VISHAY DALE	3.74K	RESISTOR; 0603; 3.74KOHMS, 1%, 100PPM, 0.1W, THICK FILM

MAX20446B EV Kit Bill of Materials (continued)

ITEM	REF_DES	DNI/DNP	QTY	MFG PART #	MANUFACTURER	VALUE	DESCRIPTION
51	R26	-	1	ERJ-3GEYJ100	PANASONIC	10	RESISTOR; 0603; 10 OHM; 5%; 200PPM; 0.10W; THICK FILM
52	R27	-	1	WSL1206R0400F	VISHAY DALE	0.04	RESISTOR; 1206; 0.04 OHM; 1%; 75PPM; 0.25W; THICK FILM
53	R28	-	1	ERJ-3EKF7151	PANASONIC	7.15K	RESISTOR; 0603; 7.15K OHM; 1%; 100PPM; 0.10W; THICK FILM
54	R32	-	1	CRCW060339K0FK	VISHAY DALE	39K	RESISTOR; 0603; 39K OHM; 1%; 100PPM; 0.10W; THICK FILM
55	R35	-	1	CRCW06038K06FK; ERJ-3EKF8061	VISHAY DALE;PANASONIC	8.06K	RESISTOR; 0603; 8.06K OHM; 1%; 100PPM; 0.1W; THICK FILM
56	R39	-	1	CRCW060376K8FK	VISHAY DALE	76.8K	RESISTOR; 0603; 76.8K OHM; 1%; 100PPM; 0.10W; THICK FILM
57	R42, R48, R55	-	3	CHPHT0603K1002FGT	VISHAY SFERNICE	10K	RESISTOR; 0603; 10K OHM; 1%; 100PPM; 0.0125W; THICK FILM
58	R44	-	1	CRCW060349K9FK; ERJ-3EKF4992	VISHAY DALE;PANASONIC	49.9K	RESISTOR; 0603; 49.9K OHM; 1%; 100PPM; 0.1W; THICK FILM
59	R46, R47	-	2	CRCW06034K70FK	VISHAY DALE	4.7K	RESISTOR; 0603; 4.7K; 1%; 100PPM; 0.10W; THICK FILM
60	R50	-	1	CRCW06031K40FK	VISHAY DALE	1.4K	RESISTOR; 0603; 1.4K OHM; 1%; 100PPM; 0.1W; THICK FILM
61	R51	-	1	RN73C1J10RBTG; 1614350-2	TE CONNECTIVITY;TE CONNECTIVITY	10	RESISTOR; 0603; 10 OHM; 0.1%; 10PPM; 0.063W; THICK FILM
62	R52	-	1	CRCW060313K3FK; ERJ-3EKF1332	VISHAY DALE;PANASONIC	13.3K	RESISTOR; 0603; 13.3K OHM; 1%; 100PPM; 0.1W; THICK FILM
63	R54	-	1	ERJ-3EKF3481	PANASONIC	3.48K	RESISTOR; 0603; 3.48K OHM; 1%; 100PPM; 0.1W; THICK FILM
64	SPACER1-SPACER4	-	4	9032	KEYSTONE	9032	MACHINE FABRICATED; ROUND-THRU HOLE SPACER; NO THREAD; M3.5; 5/8IN; NYLON
65	U1	-	1	MAX20446BATG/V+	MAXIM	MAX20446BATG/V+	EVKIT PART; IC; AUTOMOTIVE 6-CHANNEL BACKLIGHT DRIVER WITH BOOST/SEPIC CONTROLLER; HYBRID DIMMING AND I2C INTERFACE; PACKAGE OUTLINE DRAWING: 21-0139; LAND PATTERN NUMBER: 90-0022; PACKAGE CODE: T2444+4C; TQFN24-EP
66	PCB	-	1	MAX20446B	MAXIM	PCB	PCB:MAX20446B
67	C1, C19, C3	DNP	0	N/A	N/A	OPEN	CAPACITOR; SMT (0603); OPEN; FORMFACTOR
68	C7, C8	DNP	0	C1210C475K5RAC; GRM32ER71H475KA88; GCM32ER71H475KA55; CGA6P3X7R1H475K250AB	KEMET;MURATA;MURATA; TDK;TAIYO YUDEN;TDK	4.7UF	CAPACITOR; SMT (1210); CERAMIC CHIP; 4.7UF; 50V; TOL=10%; TG=-55 DEGC TO +125 DEGC; TC=X7R
69	C15, C30, C32	DNP	0	C2012X7R1H225K125AC	TDK	2.2UF	CAPACITOR; SMT (0805); CERAMIC CHIP; 2.2UF; 50V; TOL=10%; TG=-55 DEGC TO +125 DEGC; TC=X7R
70	L3	DNP	0	XAL5050-103ME	COILCRAFT	10UH	INDUCTOR; SMT; COMPOSITE CORE; 10UH; TOL=+/-20%; 4.9A
71	R1, R33	DNP	0	N/A	N/A	OPEN	RESISTOR; 0603; OPEN; FORMFACTOR
72	R56	DNP	0	CRCW12060000ZS; ERJ-8GEY0R00	VISHAY DALE;PANASONIC	0	RESISTOR; 1206; 0 OHM; 0%; JUMPER; 0.25W; THICK FILM
73	C29	DNP	0	N/A	N/A	OPEN	EVKIT USE ONLY; DUAL PACKAGE OUTLINE 0603 AND 0805 NON-POLAR CAPACITOR
74	R31	DNP	0	N/A	N/A	OPEN	RESISTOR; 1206; OPEN; FORMFACTOR
TOTAL			144				

MAX20446B EV Kit Schematics

MECHANICAL

STAND OFF

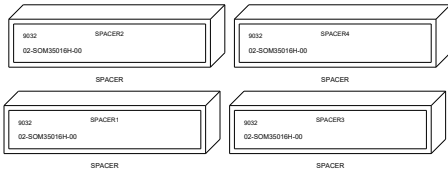

MOUNTING HOLE

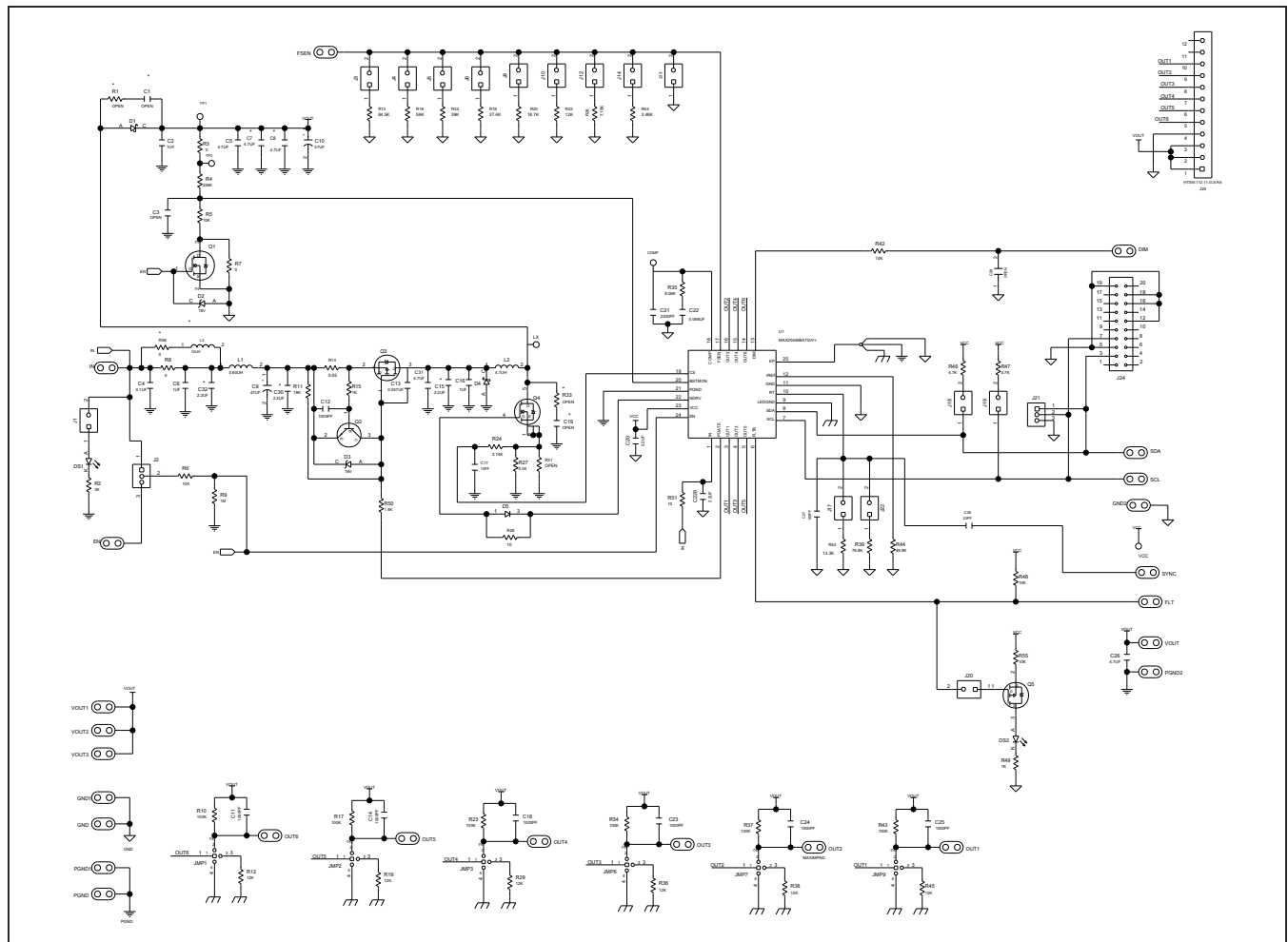

MAX20446B EV Kit PCB Layout Diagrams

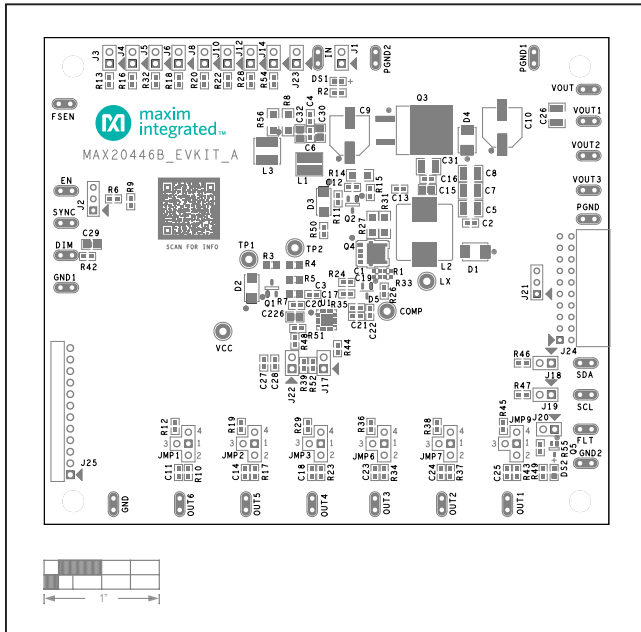

MAX20446B EV Kit Component Placement Guide—Top Silkscreen

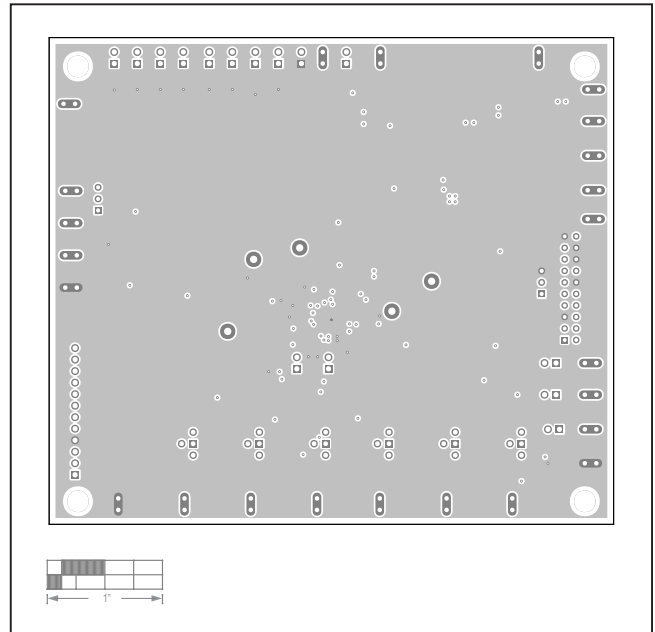

MAX20446B EV Kit PCB Layout—Internal Layer 2

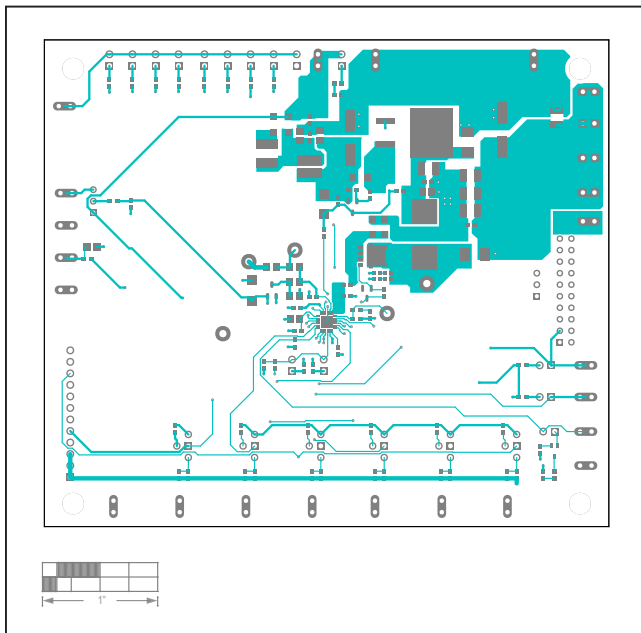

MAX20446B EV Kit PCB Layout—Top Layer

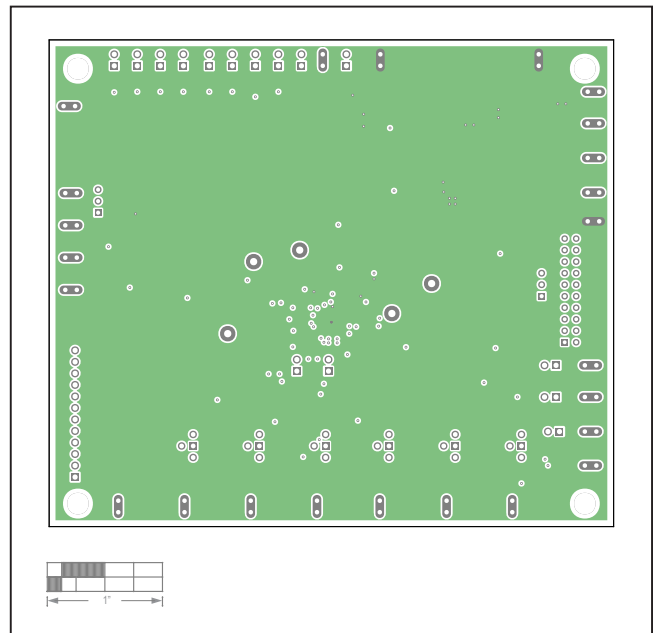

MAX20446B EV Kit PCB Layout—Internal Layer 3

MAX20446B EV Kit PCB Layout Diagrams (continued)

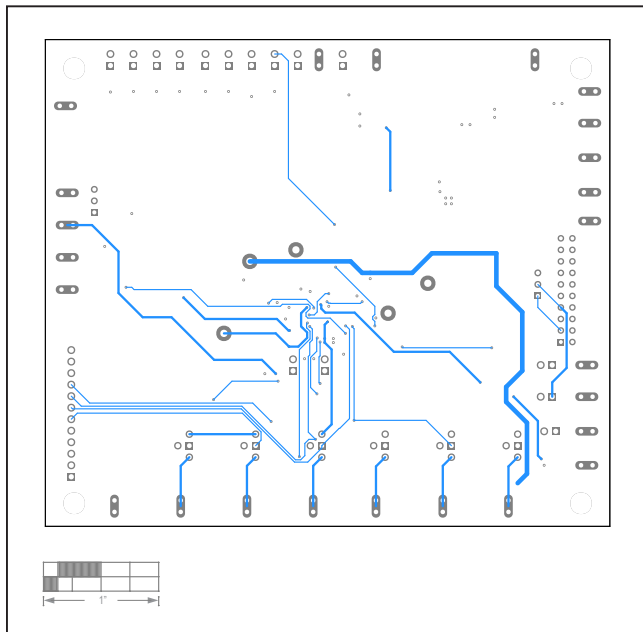

MAX20446B EV Kit PCB Layout—Bottom Layer

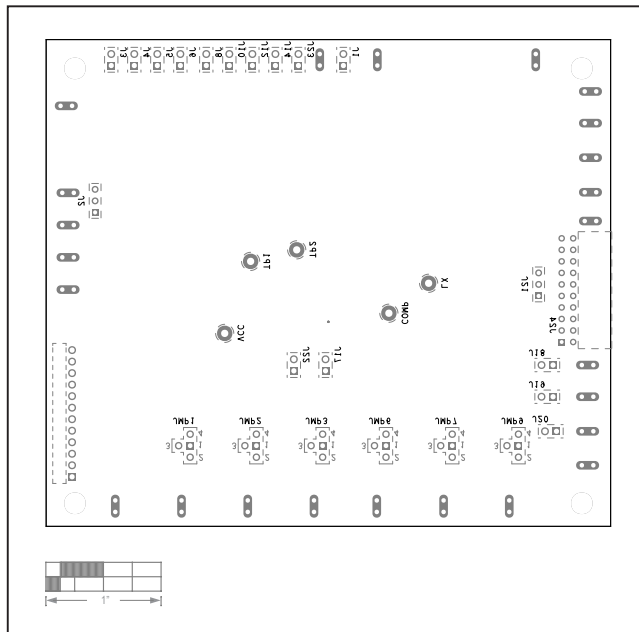

MAX20446B EV Kit PCB Layout—Bottom Silkscreen

Revision History

REVISION NUMBER	REVISION DATE	DESCRIPTION	PAGES CHANGED
0	1/21	Initial release	—

For pricing, delivery, and ordering information, please visit Maxim Integrated's online storefront at <https://www.maximintegrated.com/en/storefront/storefront.html>.

Maxim Integrated cannot assume responsibility for use of any circuitry other than circuitry entirely embodied in a Maxim Integrated product. No circuit patent licenses are implied. Maxim Integrated reserves the right to change the circuitry and specifications without notice at any time.