



Quality Products. Service Excellence.

Isolation (115VAC to 90-130VAC) 169 Series

Hard Wired



Features

- Primary 115VAC, 60 Hz.
- Secondary taps @ 90, 100, 110, 115, 120 & 130VAC
- Electrostatic shield between primary & secondary
- Connection by flexible leads, 8" minimum length
- Perfect for critical line voltage needs (examples: older "classic" tube equipment or Japanese 100V equipment).
- CSA certified (# LR3902) - except 169J
- **Remember** - These units do NOT convert line frequency

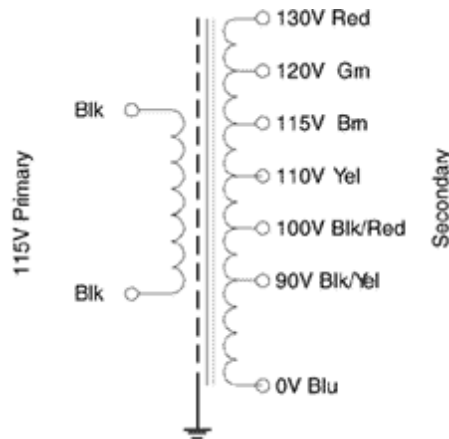
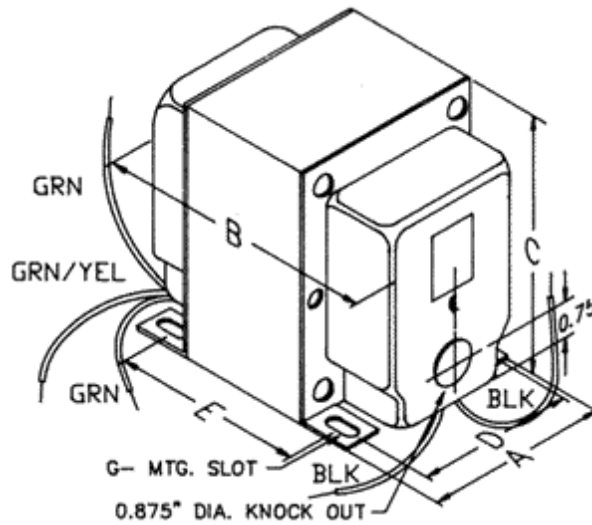

Part No.	Capacity	Overall Dimensions					Weight
	VA	A	B	C	D	E	Lbs
169C	100	2.50	3.50	3.20	2.00	2.44	4
169E	250	3.75	5.44	4.56	3.00	4.31	14.5
169G	500	3.75	5.44	4.56	3.00	4.31	15
169J	750	4.38	6.10	5.30	3.50	4.50	22

© 2023. Hammond Manufacturing Ltd. All rights reserved.