

SF2416D

490 MHz  
SAW Filter

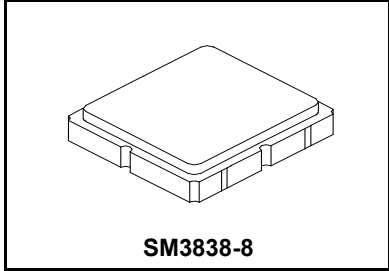

- No External Matching Required
- 3.8 x 3.8 x 1.4 mm Surface-mount Package
- Complies with Directive 2002/95/EC (RoHS)
- Moisture Sensitivity Level: 1

**Absolute Maximum Ratings**

Rating	Value	Units
Maximum Incident Power in Passband	+10	dBm
Maximum DC Voltage between any Two Terminals	3	VDC
Operating Temperature Range	-40° to +85°	°C
Storage Temperature Range	-40° to +85°	°C

**Electrical Characteristics - For Operating/Storage Temperature -40° to 85°C**

Characteristic	Sym	Notes	Min	Typ	Max	Units
Center Frequency	$F_C$			490		MHz
Insertion Loss (480 to 500 MHz)	IL			2.4	4	dB
Amplitude Ripple (480 to 500 MHz)				0.9	2.8	dB
Return Loss (480 to 500 MHz)			6	7.3		dB
Attenuation (referenced from 0 dB)						dB
0.3 to 300 MHz			30	58		
300 to 380 MHz			24	55		
380 to 460 MHz			15	50		
534.825 to 554.825			12	53		
559.65 to 579.65 MHz			28	55		
669.3 to 689.3 MHz			24	49		
689.3 to 1000 MHz			26	43		
Frequency Temperature Coefficient				-36		ppm/°C
Case Style			SM3838-8 3.8 x 3.8 mm Nominal Footprint			
Lid Symbolization (Y=year, WW=week, S=shift)			B35 YWWS			

**Electrical Connections**

Connection	Terminals
Port 1	2
Port 2	6
Case Ground	All others

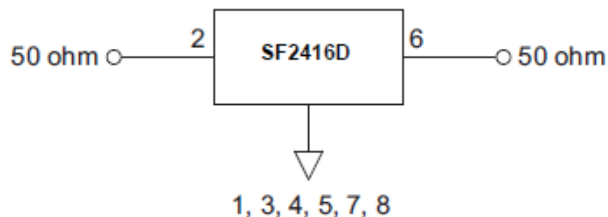

**CAUTION: Electrostatic Sensitive Device. Observe precautions for handling.**

**NOTES:**

1. The design, manufacturing process, and specifications of this device are subject to change.
2. US or International patents may apply.
3. RoHS compliant from the first date of manufacture.

**Electrical Characteristics - Operating Temperature -10° to +50°C**

Characteristic	Sym	Notes	Min	Typ	Max	Units
Center Frequency	$F_C$	1		490		MHz
Insertion Loss (480 to 500 MHz)	IL	1		2.4	3.2	dB
Amplitude Ripple (480 to 500 MHz)		1		0.9	2.4	dB
Return Loss (480 to 500 MHz)		1	6	7.3		dB
Attenuation (referenced from 0 dB)						dB
0.3 to 300 MHz			30	58		
300 to 380 MHz			24	55		
380 to 460 MHz			15	50		
534.825 to 554.825			12	53		
559.65 to 579.65 MHz			28	55		
669.3 to 689.3 MHz			24	49		
689.3 to 1000 MHz			26	43		
Frequency Temperature Coefficient				-36		ppm/°C

# SF2416D Frequency Response

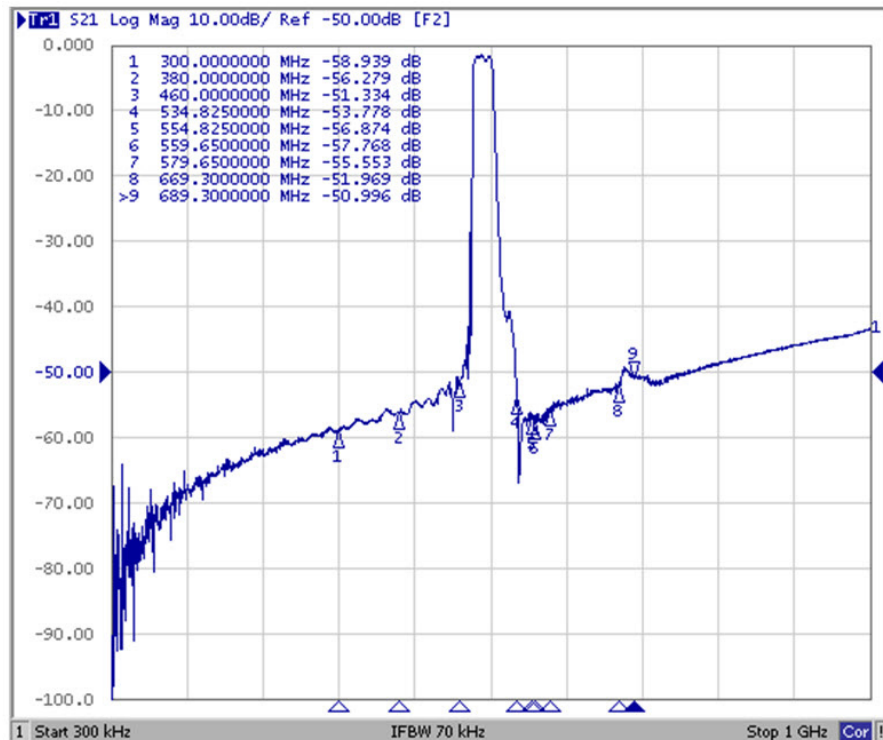
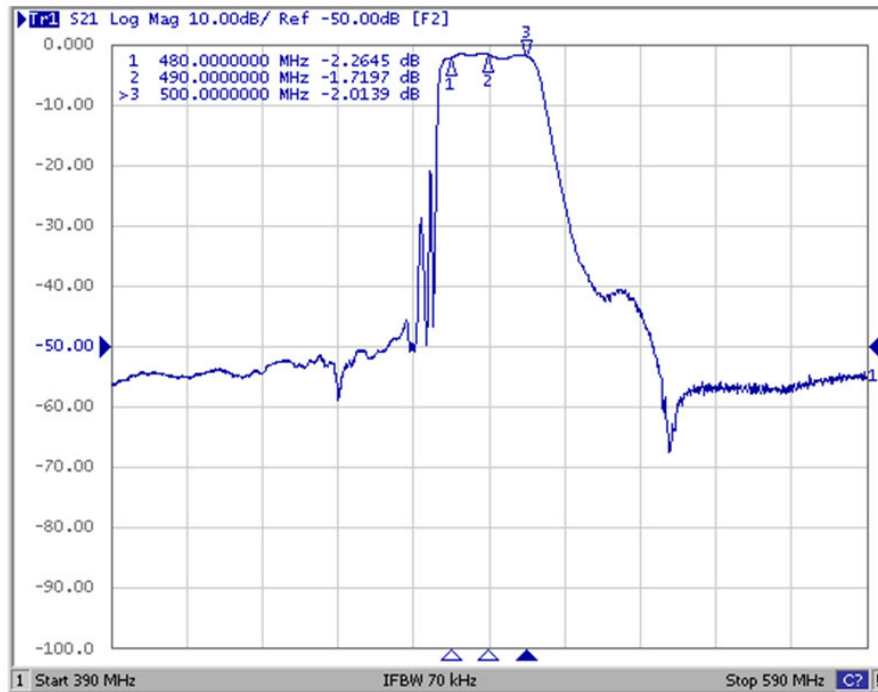

# SM3838-8 Case

## 8-Terminal Ceramic Surface-Mount Case

### 3.8 X 3.8 mm Nominal Footprint

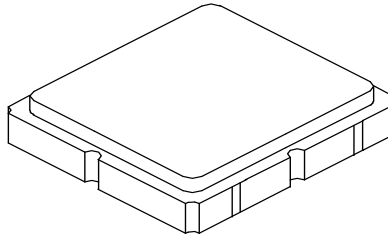

Top View

Bottom View

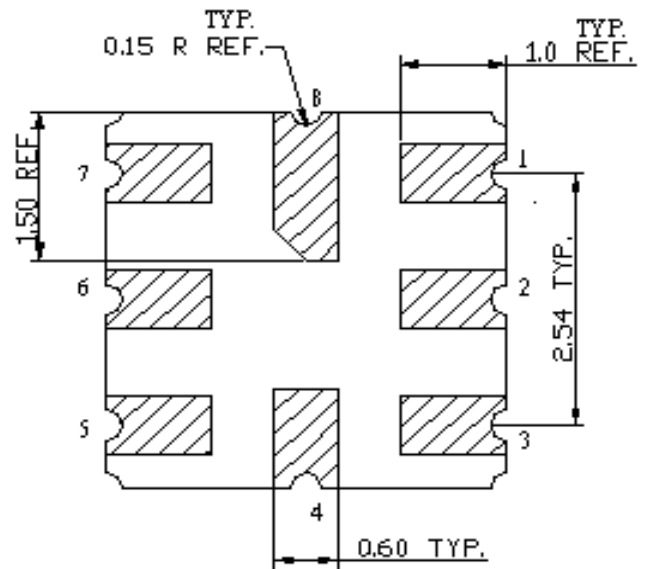
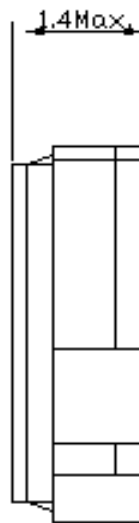
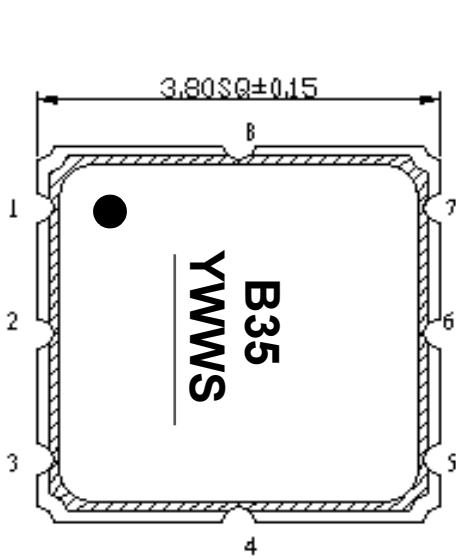

### PCB Footprint

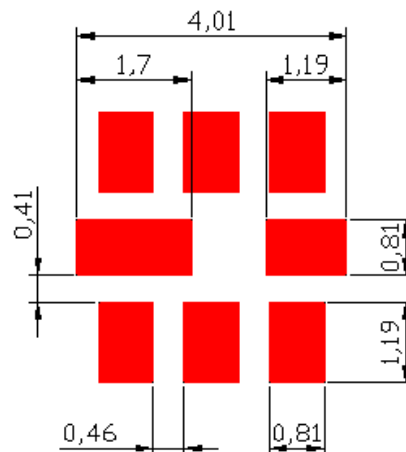

## Tape and Reel Specifications

Tape and Reel Standard per ANSI/EIA-481

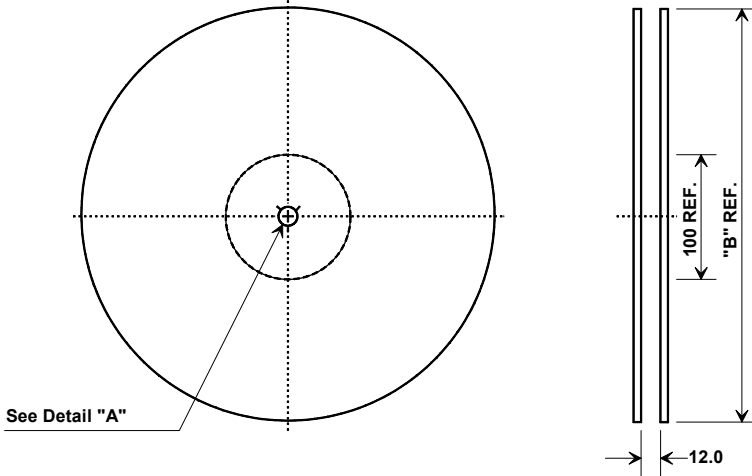

"B" Nominal Size		Quantity Per Reel
Inches	millimeters	
7	178	500
13	330	3000

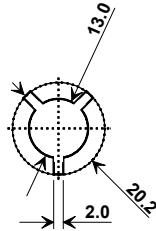

### COMPONENT ORIENTATION and DIMENSIONS

Carrier Tape Dimensions	
Ao	4.25 mm
Bo	4.25 mm
Ko	1.30 mm
Pitch	8.0 mm
W	12.0 mm

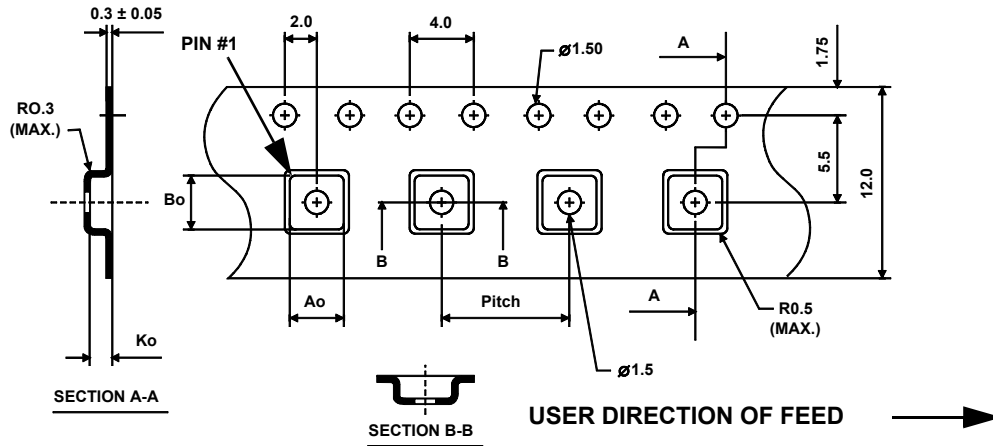

## Recommended Reflow Profile

1. Preheating shall be fixed at 150~180°C for 60~90 seconds.
2. Ascending time to preheating temperature 150°C shall be 30 seconds min.
3. Heating shall be fixed at 220°C for 50~80 seconds and at 260°C +0/-5°C peak (10 seconds).
4. Time: 5 times maximum.

