



The Future of Analog IC Technology®

MP6535

5V-to-55V, Three Phase Brushless DC Motor Pre-Driver With Buck Regulator

DESCRIPTION

The MP6535 is a gate driver IC designed for three-phase brushless DC motor driver applications. It is capable of driving three half bridges consisting of six N-channel power MOSFETs up to 55V.

It includes a 500mA buck regulator to generate local power for a microcontroller or other circuitry,

The MP6535 integrates a regulated charge pump to generate gate drive power, and uses a bootstrap capacitor to generate a supply voltage for the high-side MOSFET driver. An internal trickle-charge circuit maintains sufficient high-side gate driver voltage even when an output is operated at 100% duty cycle

Internal protection features include programmable short-circuit protection, over-current protection, adjustable dead-time control, undervoltage lockout, and thermal shutdown.

The device integrates 120° commutation using three Hall sensor inputs. The PWM, DIR, and nBRAKE inputs are used to control motor speed, direction, and braking.

The MP6535 is available in a 40-contact 5mmx5mm QFN with an exposed thermal pad.

FEATURES

- Wide 5V to 55V Input Voltage Range
- Built-in Hall Sensor Inputs and 120° Commutation Logic
- Charge Pump Gate Drive Supply
- Bootstrap High-Side Driver with Trickle-Charge Circuit Supports 100% Duty Cycle Operation
- 500mA buck regulator
- Low Power Sleep Mode
- Programmable Short-Circuit Protection
- Over-Current Protection
- Adjustable Dead-Time Control to Prevent Shoot-Through
- Thermal Shutdown and UVLO Protection
- Fault Indication Output
- Thermally Enhanced Surface-Mount Package

APPLICATIONS

- 3-Phase Brushless DC Motors and Permanent Magnet Synchronous Motors
- Power Drills
- E-Bike

All MPS parts are lead-free, halogen free, and adhere to the RoHS directive. For MPS green status, please visit MPS website under Quality Assurance. "MPS" and "The Future of Analog IC Technology" are Registered Trademarks of Monolithic Power Systems, Inc.

TYPICAL APPLICATION

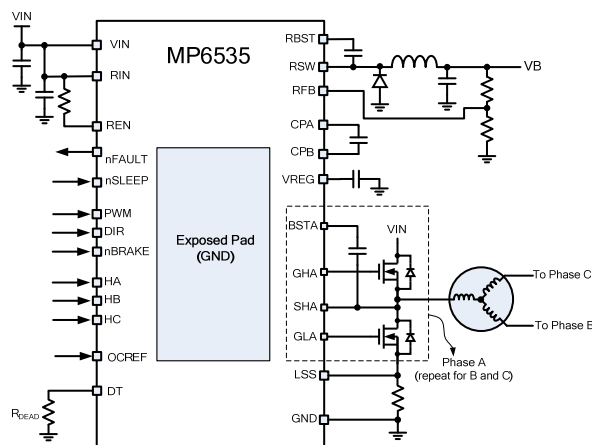

ORDERING INFORMATION

Part Number*	Package	Top Marking
MP6535GU	QFN-40 (5mmx5mm)	See Below

* For Tape & Reel, add suffix -Z (e.g. MP6535GU-Z)

TOP MARKING

MPSYYWW

MP6535

LLLLLLL

MPS: MPS prefix;
 YY: year code;
 WW: week code;
 MP6535: part number;
 LLLLLLL: lot number;

PACKAGE REFERENCE

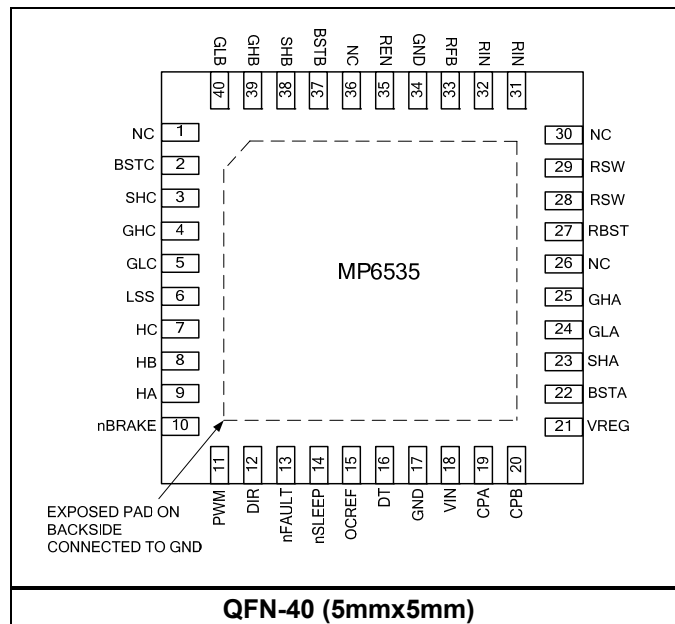

ABSOLUTE MAXIMUM RATINGS ⁽¹⁾

Input Voltage V_{IN}	-0.3V to 65V
Input Voltage V_{RIN}	-0.3V to 60V
RSW	-0.3V to $V_{RIN}+0.3V$
RBST	$V_{RSW} +6V$
CPA	-0.3V to 60V
CPB	-0.3V to 12.5V
VREG	-0.3V to 13V
BSTA/B/C	-0.3V to 70V
GHA/B/C	-0.3V to 70V
GHA/B/C (Transient, 2 μ S)	-8V to 70V
SHA/B/C	-0.3V to 60V
SHA/B/C (Transient, 2 μ S)	-8V to 65V
GLA/B/C	-0.3V to 13V
ESD Rating (HBD)	2kV
All Other Pins to AGND	-0.3V to 6.5V
Continuous Power Dissipation ($T_A = +25^\circ C$) ⁽²⁾	
QFN-40 (5mmx5mm).....	3.47W
Storage Temperature.....	-55 $^\circ C$ to +150 $^\circ C$
Junction Temperature.....	+150 $^\circ C$
Lead Temperature (Solder)	+260 $^\circ C$
ESD (Human Body Model).....	1500V

Recommended Operating Conditions ⁽³⁾

Input Voltage V_{IN}, V_{RIN}	+5V to 55V
OCREF Voltage V_{OC}	+0.125V to 2.4V
Operating Junct. Temp (T_J)	-40 $^\circ C$ to +125 $^\circ C$

Thermal Resistance ⁽⁴⁾	θ_{JA}	θ_{JC}	
QFN-40 (5mmx5mm).....	36	8	$^\circ C/W$

Notes:

- 1) Exceeding these ratings may damage the device.
- 2) The maximum allowable power dissipation is a function of the maximum junction temperature T_J (MAX), the junction-to-ambient thermal resistance θ_{JA} , and the ambient temperature T_A . The maximum allowable continuous power dissipation at any ambient temperature is calculated by P_D (MAX) = $(T_J$ (MAX)- T_A)/ θ_{JA} . Exceeding the maximum allowable power dissipation will cause excessive die temperature, and the regulator will go into thermal shutdown. Internal thermal shutdown circuitry protects the device from permanent damage.
- 3) The device is not guaranteed to function outside of its operating conditions.
- 4) Measured on JESD51-7, 4-layer PCB.

ELECTRICAL CHARACTERISTICS (MOTOR PRE-DRIVER)
V_{IN} =24V, T_A = 25°C, unless otherwise noted.

Parameter	Symbol	Condition	Min	Typ	Max	Units
Power Supply						
Input Supply Voltage	V _{IN}		5		55	V
Quiescent Current	I _Q	nSLEEP=1, gate not switching		0.95	2	mA
	I _{SLEEP}	nSLEEP=0			1	μA
Control Logic						
Input Logic 'Low' Threshold	V _{IL}				0.8	V
Input Logic 'High' Threshold	V _{IH}		2			V
Logic Input Current	I _{IN(H)}	V _{IH} =5V	-20		20	μA
	I _{IN(L)}	V _{IL} =0.8V	-20		20	μA
nSLEEP Pull Down Current	I _{SLEEP-PD}			1		μA
Internal Pull Down Resistance	R _{PD}	All logic inputs except nSLEEP		880		kΩ
Fault Outputs(Open-Drain Outputs)						
Output Low Voltage	V _{OL}	I _O =5mA			0.5	V
Output High Leakage Current	I _{OH}	V _O =3.3V			1	μA
Protection Circuit						
UVLO Rising Threshold	V _{IN_RISE}		3.3	3.9	4.5	V
UVLO Hysteresis	V _{IN_HYS}			200		mV
VREG Rising Threshold	V _{REG_RISE}		6.8	7.6	8.4	V
VREG Hysteresis	V _{REG_HYS}			0.54	1	V
VREG Startup Delay	t _{REG}			800		μs
OCREF Threshold	V _{OC}	V _{OC} =1V	0.8	1	1.2	V
		V _{OC} =2.4V	2.18	2.4	2.62	V
OCP Deglitch Time	t _{OC}			3		μs
SLEEP Wakeup Time	t _{SLEEP}			1		ms
LSS Current Limit Threshold	V _{LSS-OCP}		0.4	0.5	0.6	V
LSS Current Limit Fixed Off Time			53	66	80	μs
LSS Current Limit High side Minimum On Time	V _{LSS-OCP}			1		μs
Thermal Shutdown	T _{TSD}			150		°C

ELECTRICAL CHARACTERISTICS (MOTOR PRE-DRIVER) (continued)
 $V_{IN} = 24V$, $T_A = 25^{\circ}C$, unless otherwise noted.

Parameter	Symbol	Condition	Min	Typ	Max	Units
Gate Drive						
Bootstrap Diode Forward Voltage	V_{FBOOT}	$I_D = 10mA$			0.9	V
		$I_D = 100mA$			1.3	V
VREG Output Voltage	V_{REG}	$V_{IN} = 5.5V - 55V$	10	11.5	12.8	V
		$V_{IN} = 5V$	$2 \times V_{IN} - 1$			V
Maximum source current	$I_{OSO}^{(5)}$			0.8		A
Maximum sink current	$I_{OSI}^{(5)}$			1		A
Gate Drive Pull Up Resistance	R_{UP}	$V_{DS} = 1V$		8		Ω
HS Gate Drive Pull Down Resistance	R_{HS-DN}	$V_{DS} = 1V$	1.2		4.3	Ω
LS Gate Drive Pull Down Resistance	R_{LS-DN}	$V_{DS} = 1V$	1		5	Ω
LS Automatic Turn On Time	t_{LS}	At each commutation time		1.8		μs
Charge Pump Frequency	f_{CP}			110		kHz
Dead Time	t_{DEAD}	Leave DT Open		6		μs
		$R_{DT} = 200k\Omega$		0.74		μs
		DT tied to GND		30		ns

NOTE:

(5) Guaranteed by design – not tested in production

ELECTRICAL CHARACTERISTICS (BUCK REGULATOR)
 $V_{RIN} = 12V$, $T_A = 25^\circ C$, unless otherwise noted.

Parameters	Symbol	Condition	Min	Typ	Max	Units
Feedback Voltage	V_{FB}		0.792	0.812	0.832	V
Feedback Current	I_{FB}	$V_{RFB} = 0.85V$			0.1	μA
Switch-On Resistance	$R_{DS(ON)}$			1		Ω
Switch Leakage	I_{SW_LKG}	$V_{REN} = 0V$, $V_{RSW} = 0V$			1	μA
Current Limit	I_{LIM}		1.0	1.25	1.5	A
Oscillator Frequency	f_{SW}	$V_{FB} = 0.6V$	330	450	570	kHz
Foldback Frequency	f_{SW_F}	$V_{RFB} = 0V$		135		kHz
Maximum Duty Cycle	D_{MAX}	$V_{RFB} = 0.6V$	90	93.5		%
Minimum ON-Time	T_{ON}			100		ns
Under-Voltage Lockout Threshold, Rising	V_{UVLO_R}		2.9	3.3	3.7	V
Under-Voltage Lockout Threshold, Falling	V_{UVLO_F}		2.55	3.05	3.45	V
Under-Voltage Lockout Threshold, Hysteresis	V_{UVLO_HYS}			320		mV
REN Threshold, Rising	V_{EN_R}			1.35		V
REN Threshold, Falling	V_{EN_F}			1.17		V
REN Threshold, Hysteresis	V_{EN_HYS}			180		mV
REN Input Current	I_{EN}	$V_{REN} = 2V$		3.1		μA
		$V_{REN} = 0V$		0.1		
Supply Current (Shutdown)	I_S	$V_{REN} = 0V$		0.1	1.0	μA
Supply Current (Quiescent)	I_Q	$V_{REN} = 2V$, $V_{FB} = 1V$		0.73	0.85	mA
Thermal Shutdown	T_{SD}			165		$^\circ C$
Thermal Shutdown Hysteresis	T_{SD_HYS}			20		$^\circ C$

TYPICAL CHARACTERISTICS

Motor Pre-Driver

UVLO Rising Threshold vs. Temperature

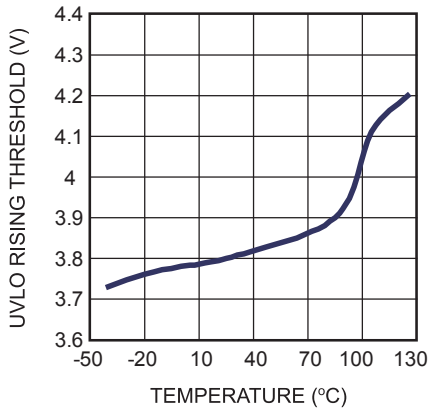

VREG Rising Threshold vs. Temperature

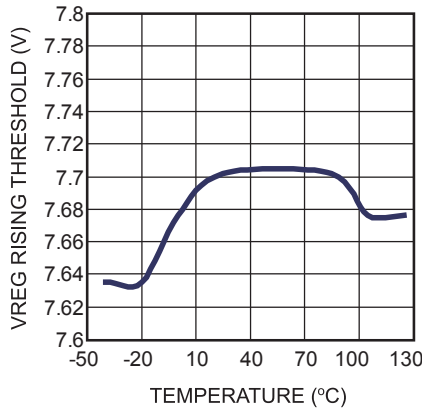

OC_REF Threshold vs. Temperature

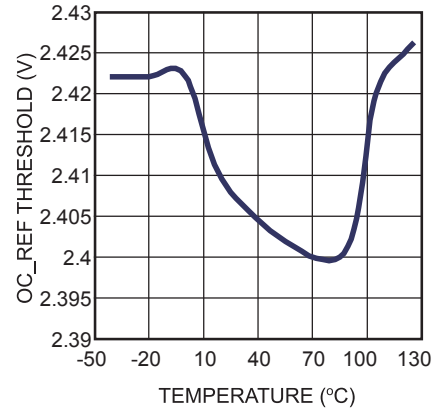

LSS Current Limit Threshold vs. Temperature

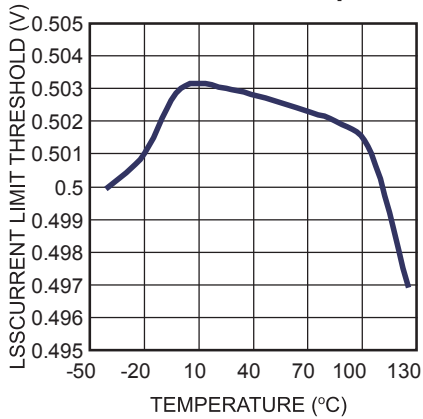

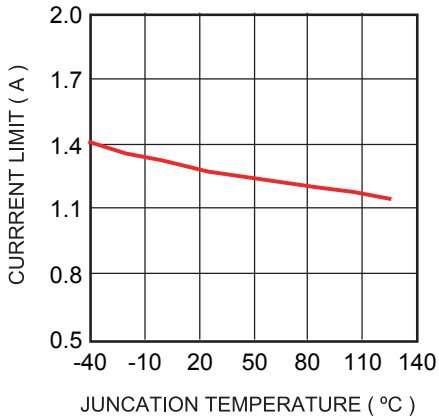
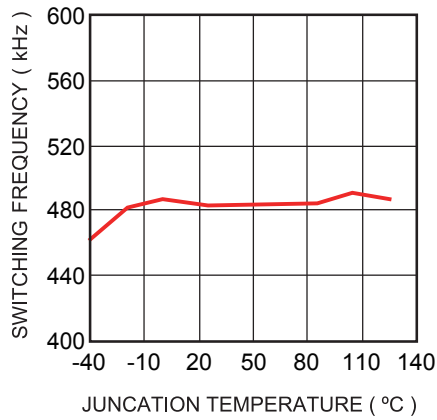
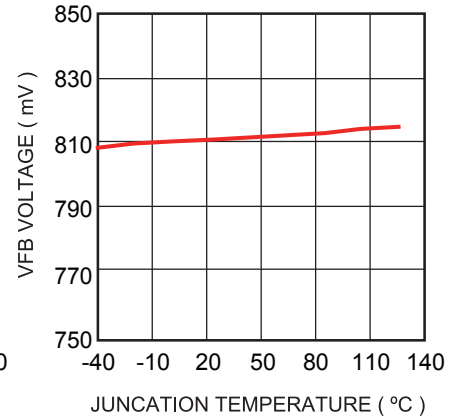
TYPICAL CHARACTERISTICS (continued)
Buck Regulator
Current Limit vs. Temperature

Frequency vs. Temperature

Feedback Voltage vs. Temperature

TYPICAL PERFORMANCE CHARACTERISTICS

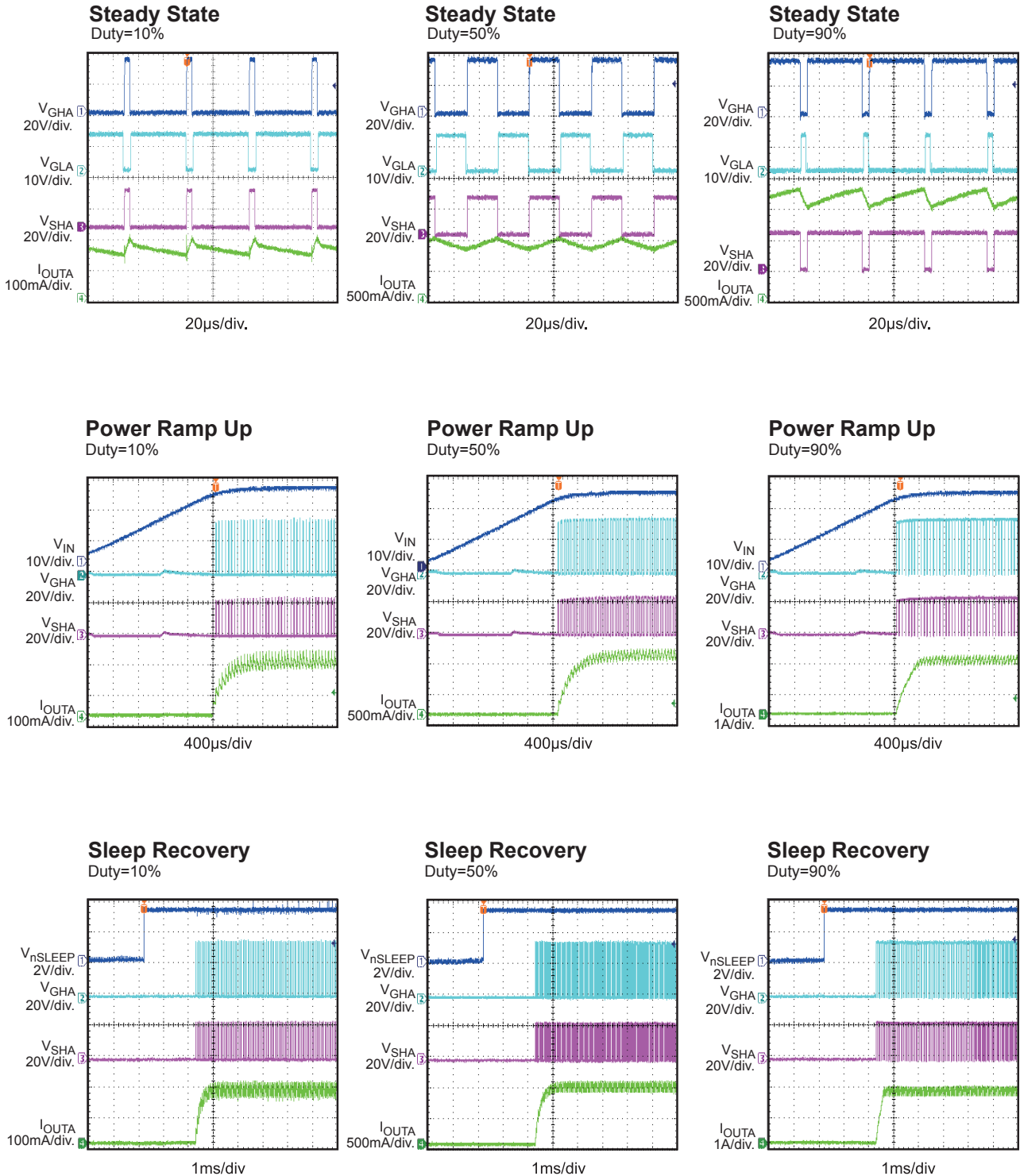
Motor Pre-Driver

$V_{IN}=24V$, $OCREF=0.5V$, $R_{DT}=200k$, $DIR=H$, $HA=HC=H$, $HB=L$, $F_{PWM}=20kHz$, $T_A=25^{\circ}C$,
 Resistor+Inductor Load: 5ohm+1mH/phase with star connection, unless otherwise noted.



TYPICAL PERFORMANCE CHARACTERISTICS (continued)
Motor Pre-Driver

$V_{IN}=24V$, $OCREF=0.5V$, $R_{DT}=200k$, $DIR=H$, $HA=HC=H$, $HB=L$, $F_{PWM}=20kHz$, $T_A=25^\circ C$,
Resistor+Inductor Load: 5ohm+1mH/phase with star connection, unless otherwise noted.

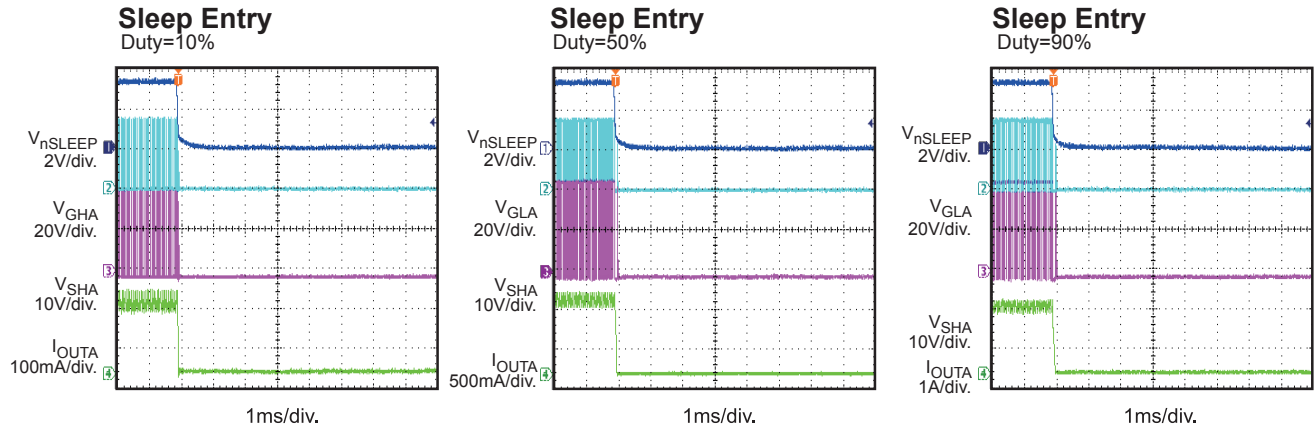

TYPICAL PERFORMANCE CHARACTERISTICS

Buck Regulator

$V_{IN}=12V$, $V_{OUT}=5V$, $L=22\mu H$, $T_A=25^\circ C$, unless otherwise noted.

Steady State

$V_{IN}=8V$, $I_{OUT}=0.8A$

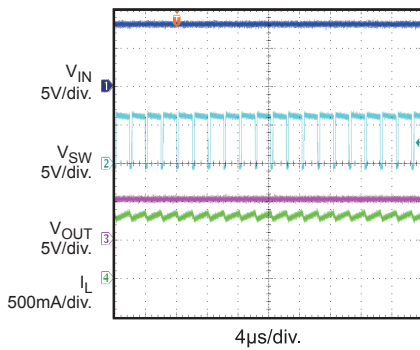

Steady State

$I_{OUT}=0.15A$

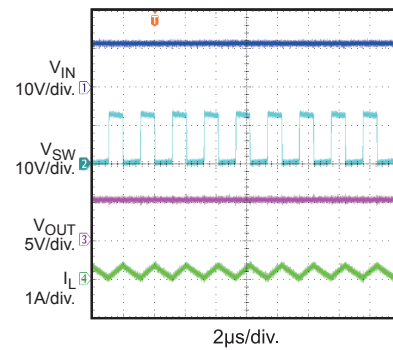

Load Transient

$I_{OUT}=0.2A$ to $0.7A$

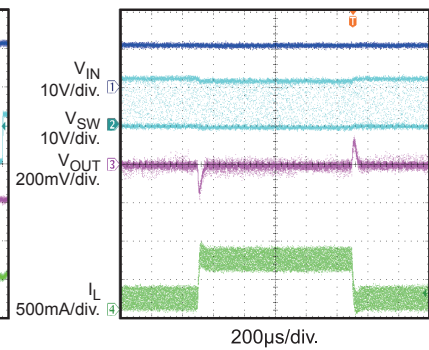

Steady State

$V_{IN}=6V$, $V_{OUT}=3.3V$, $I_{OUT}=0.1A$

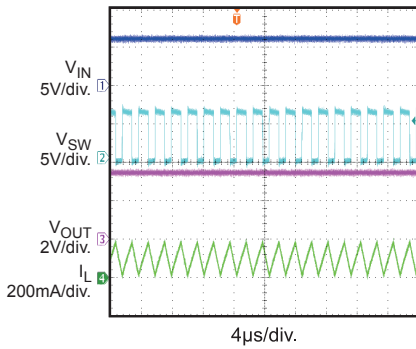

Steady State

$V_{IN}=60V$, $V_{OUT}=3.3V$, $I_{OUT}=0.9A$

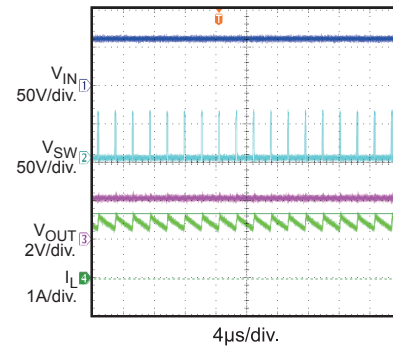

Load Transient

$V_{OUT}=3.3V$, $I_{OUT}=0.2A$ to $0.7A$

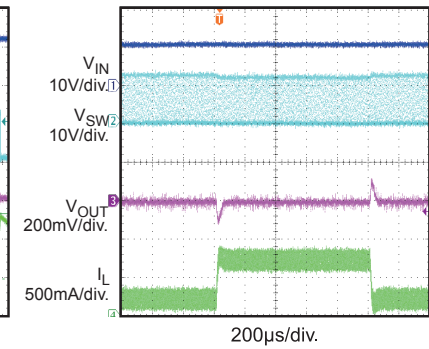

Power Ramp Up

$V_{IN}=60V$, $I_{OUT}=0.5A$

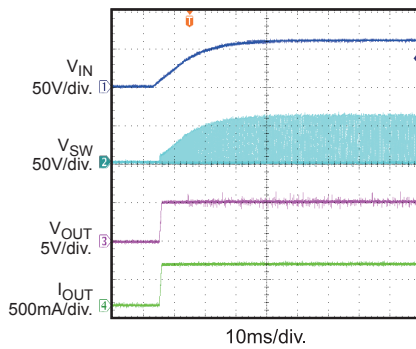

Power Ramp Down

$V_{IN}=60V$, $I_{OUT}=0.5A$

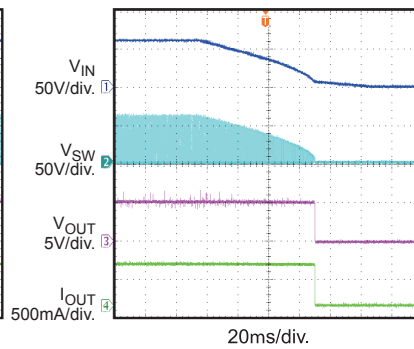

Short Output

$I_{OUT}=0.65A$

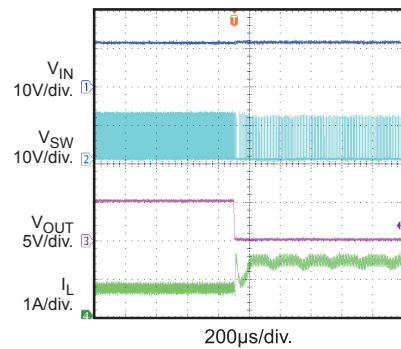

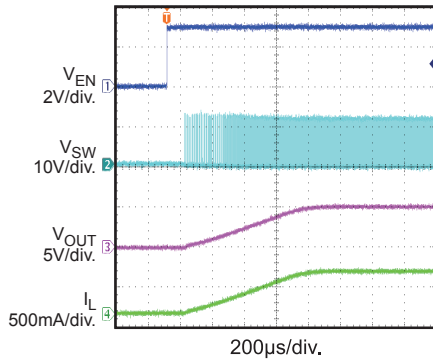
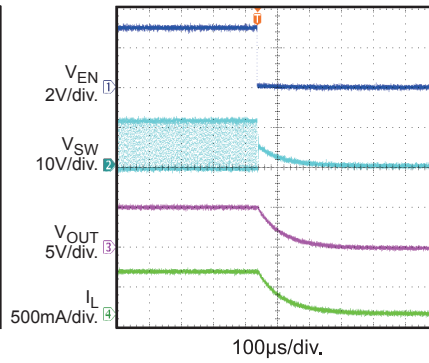
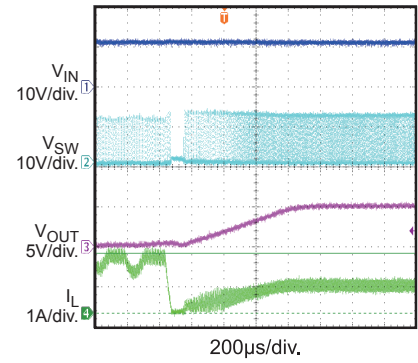
TYPICAL PERFORMANCE CHARACTERISTICS (continued)
Buck Regulator
 $V_{IN}=12V$, $V_{OUT}=5V$, $L=22\mu H$, $T_A=25^\circ C$, unless otherwise noted.
Enable On
 $I_{OUT}=0.5A$

Enable Off
 $I_{OUT}=0.5A$

Short Output Recovery
 $I_{OUT}=0.65A$

PIN FUNCTIONS

Pin #	Name	Description
1, 26, 30, 36	N/C	Not Connected.
2	BSTC	Bootstrap phase C. Connect a ceramic capacitor to SHC. See Applications Information section.
3	SHC	High-side source connection phase C.
4	GHC	High-side gate drive phase C.
5	GLC	Low-side gate drive phase C.
6	LSS	Low-side source connection.
7	HC	Hall-sensor input, phase C. Internal pulldown.
8	HB	Hall-sensor input, phase B. Internal pulldown.
9	HA	Hall-sensor input, phase A. Internal pulldown.
10	nBRAKE	Brake input. Active low input turns on all low-side MOFSETs to brake motor; high for normal operation. Internal pulldown.
11	PWM	External PWM input. When active high, the phase selected by the commutation logic is driven high; when low, the phase is low. Internal pulldown.
12	DIR	Direction input. High or low sets the motor rotation direction. Refer to commutation table for details.
13	nFAULT	Fault indication. Open-drain output. nFAULT is logic low when in a fault condition.
14	nSLEEP	Sleep mode input. Logic low to enter low-power sleep mode; high to enable. Internal pulldown.
15	OCREF	Over-current protection reference voltage input.
16	DT	Dead time setting. Connect a resistor to ground to set the dead time. See Applications Information section.
17, 34	GND	Ground.
18	VIN	Input supply voltage. Bypass to ground with a ceramic capacitor. Additional bulk capacitance may be required. See Applications Information section.
19	CPA	Charge pump capacitor. Connect a ceramic capacitor between these pins. See Applications Information section.
20	CPB	
21	VREG	Gate drive supply output. Connect a ceramic capacitor to ground. See Applications Information section.
22	BSTA	Bootstrap phase A. Connect a ceramic capacitor to SHA. See Applications Information section.
23	SHA	High-side source connection phase A.
24	GLA	High-side gate drive phase A.
25	GHA	Low-side gate drive phase A.
27	RBST	Buck regulator boost pin. Connect a ceramic capacitor between the RSW and RBST pins.
28, 29	RSW	Buck regulator switch output.
31, 32	RIN	Buck regulator input (normally connected to VIN).
33	RFB	Buck regulator feedback input. Sets the buck regulator output voltage. Connect to the tap of an external resistor divider from the output to GND. The frequency foldback comparator lowers the oscillator frequency when the FB voltage is below 250mV to prevent current-limit runaway during a short-circuit fault.
35	REN	Buck regulator enable. Pull EN above 1.2V to turn the buck regulator ON. For automatic enable, connect to VIN using a 100kΩ resistor.
37	BSTB	Bootstrap phase B. Connect a ceramic capacitor to SHB. See Applications Information section.
38	SHB	High-side source connection phase B.
39	GHB	High-side gate drive phase B.
40	GLB	Low-side gate drive phase B.

OPERATION

The MP6535 is a three-phase BLDC motor pre-driver with built-in commutation logic that drives three external N-channel MOSFET half bridges, with 0.8A source and 1A sink current capability. It operates over a wide input voltage range of 5V to 60V, generating a boosted gate drive voltage when the input supply is below 12V. The MP6535 features a low-power sleep mode, which disables the device and draws a very low supply current.

The MP6535 provides several flexible functions, such as adjustable dead-time control and over-current protection, which allow the device to cover a wide range of applications.

Power-Up Sequence

The power-up sequence is initiated by the application of voltage to VIN pin. To initiate power-up, VIN must be above the undervoltage lockout threshold V_{UVLO} .

After power-up begins, the VREG supply starts operating. VREG must rise above V_{REG_RISE} before the device becomes functional.

The power-up process takes between 1mS and 2mS, after which the MP6535 will respond to logic inputs and drive the outputs.

Gate Drive Power Supplies

Gate drive voltages are generated from the input power, VIN. A regulated charge pump doubler circuit supplies a voltage of approximately 11.5V at the VREG pin. This voltage is used for the low-side gate drive supply. The charge pump requires external capacitors between the CPA and CPB pins, and from VREG to ground.

The high side gate drive is generated by a combination of a bootstrap capacitor and an internal “trickle” charge pump. Bootstrap capacitors are charged to the VREG voltage when the low side MOSFET is turned on. This charge is then used to drive the high side MOSFET gate when it is turned on.

To keep the bootstrap capacitors charged and allow operation at 100% duty cycle, an internal “trickle” charge pump supplies a small current (about 5 μ A) to overcome leakages that would discharge the bootstrap capacitors.

Refer to the applications information section for details on the selection of external components.

Sleep Mode (nSLEEP Input)

Driving nSLEEP low will put the device into a low-power sleep state. In this state, all the internal circuits are disabled. All inputs are ignored when nSLEEP is active low. nSLEEP has an interval pulldown, so it must be driven high for the device to operate.

When exiting sleep mode, the power-up sequence described above is repeated.

Input Logic

The PWM input is typically connected to a PWM signal that controls the speed of the motor. DIR controls the direction of rotation. nBRAKE, when active low, turns on all low-side MOSFETs to stop the motor. This logic is shown in Table 1 below.

Table 1: Input Logic Truth Table

PWM	nBRAKE	Operation
X	L	Brake – all low-side FETs on
L	H	Selected phase driven low
H	H	Selected phase driven high

Commutation Logic and Hall Inputs

The commutation logic is driven by three Hall-sensor inputs. These inputs are connected to sensors in the motor that are spaced 120° from each other. Refer to Table 2 for the commutation logic.

At each Hall input transition, the phase that will be driven (high or low, depending on the PWM input pin) is first driven low for a short period of time (t_{LS}). This ensures that the bootstrap capacitor is charged at the beginning of each commutation cycle. Because of this, even if the PWM input is held high, each phase will pulse low before being driven high.

Table 2: Commutation Table (nBRAKE=1)

Logic Inputs				Driver Outputs						Motor Terminals		
HA	HB	HC	DIR	GLA	GLB	GLC	GHA	GHB	GHC	SHA	SHB	SHC
1	0	1	1	/PWM	0	1	PWM	0	0	H	Z	L
1	0	0	1	0	/PWM	1	0	PWM	0	Z	H	L
1	1	0	1	1	/PWM	0	0	PWM	0	L	H	Z
0	1	0	1	1	0	/PWM	0	0	PWM	L	Z	H
0	1	1	1	0	1	/PWM	0	0	PWM	Z	L	H
0	0	1	1	/PWM	1	0	PWM	0	0	H	L	Z
1	0	1	0	1	0	/PWM	0	0	PWM	L	Z	H
1	0	0	0	0	1	/PWM	0	0	PWM	Z	L	H
1	1	0	0	/PWM	1	0	PWM	0	0	H	L	Z
0	1	0	0	/PWM	0	1	PWM	0	0	H	Z	L
0	1	1	0	0	/PWM	1	0	PWM	0	Z	H	L
0	0	1	0	1	/PWM	0	0	PWM	0	L	H	Z

Note: If nBRAKE=0, the braking function would be active, all low-side gates on.

nFAULT

The nFAULT output pin reports to the system when a fault condition (such as overcurrent or overtemperature) is detected. nFAULT is an open-drain output, and it is driven low when a fault condition occurs. If the fault condition is released, nFAULT is pulled high by an external pullup resistor.

Short Circuit Protection (V_{DS} Sensing)

To protect the power stage from damage due to high currents, a VDS sensing circuitry is implemented in the MP6535. The voltage drop across each MOSFET is sensed. (This voltage is proportional to the R_{DS-ON} of the MOSFET and the I_{DS} current passing through it). If this voltage exceeds the voltage supplied to the OCREF terminal, a short circuit is recognized.

In the event of a short circuit, the MP6535 disables all of the gate drive outputs. nFAULT is driven active low. The device will stay latched off until it is reset by nSLEEP or VIN UVLO.

Short circuit protection can be disabled by connection a 100kΩ resistor from VREG to the OCREF pin.

Over-current Protection (OCP)

The MP6535 can implement output overcurrent protection (OCP) by monitoring the current through a low-side shunt resistor connected to the low-side MOSFETs. This resistor is connected to the LSS input pin and the low-side MOSFET source terminals. If the OCP function is not desired, the LSS pin and MOSFET source

terminals should all be connected directly to ground.

If the LSS voltage (the voltage across the shunt resistor) exceeds the LSS OCP threshold voltage V_{LSS-OC} , the high side will turn off and the corresponding low side turns on for a fixed off time (t_{OFF}). After the fixed off time, the high side will turn back on and the cycle repeats until LSS no longer exceeds the current limit threshold.

The OCP current limit level is selected by the value of the current sense resistor at LSS pin. Refer to the applications information section for more information.

OCP can be used to limit the stall current of a BLDC motor.

OCP protection can be disabled by connection a 100kΩ resistor from VREG to the OCREF pin.

Short-circuit and OCP Deglitch Time

There is often a current spike during switching transitions, due to body diode reverse-recovery current or the distributed capacitance of the load. This current spike requires filtering to prevent it from erroneously triggering OCP. An internal fixed deglitch time (t_{OC}) blanks the output of the VDS monitor when the outputs are switched.

Dead Time Adjustment

To prevent shoot-through in any phase of the bridge, it is necessary to have a dead time (t_{DEAD}) between a high- or low-side turn-off and the next complementary turn-on event. The dead time for all three phases is set by a single dead-time

resistor (R_{DT}) between DT and ground with Equation (1):

$$t_{DEAD}(nS) = 3.7 * R(k\Omega) \quad (1)$$

If DT is tied directly to ground, an internal minimum dead time (30ns) will be applied. Leaving DT open generates approximately a 6µs dead time.

UVLO Protection

If at any time the voltage on VIN falls below the undervoltage lockout threshold V_{IN_RISE} , all circuitry in the device is disabled and the internal logic will be reset.

Operation will resume with the power-up sequence when VIN rises above the UVLO thresholds.

After power-up, if the voltage on VREG drops below the V_{REG_RISE} threshold, the MP6535 will enter a latched fault state and disable all functions. The nFAULT pin will be driven active low. The device will stay latched off until it is reset by nSLEEP or VIN UVLO.

Thermal Shutdown

If the die temperature exceeds safe limits, the MP6535 will enter a latched fault state and disable all functions. The device will stay latched off until it is reset by nSLEEP or VIN UVLO.

Buck Regulator Operation

The buck regulator in the MP6535 is a current mode buck regulator. That is, the EA output

voltage is proportional to the peak inductor current.

At the beginning of a cycle, M1 is off. The EA output voltage is higher than the current sense amplifier output, and the current comparator's output is low. The rising edge of the 480kHz CLK signal sets the RS Flip-Flop. Its output turns on M1 thus connecting the SW pin and inductor to the input supply.

The increasing inductor current is sensed and amplified by the Current Sense Amplifier. Ramp compensation is summed to the Current Sense Amplifier output and compared to the Error Amplifier output by the PWM Comparator. When the sum of the Current Sense Amplifier output and the Slope Compensation signal exceeds the EA output voltage, the RS Flip-Flop is reset and M1 is turned off. The external Schottky rectifier diode conducts the inductor current.

If the sum of the Current Sense Amplifier output and the Slope Compensation signal does not exceed the EA output for a whole cycle, then the falling edge of the CLK resets the Flip-Flop.

The output of the Error Amplifier integrates the voltage difference between the feedback and the 0.81V bandgap reference. The polarity is such that lower than 0.81V FB pin voltage increases the EA output voltage. Since the EA output voltage is proportional to the peak inductor current, an increase in its voltage also increases current delivered to the output.

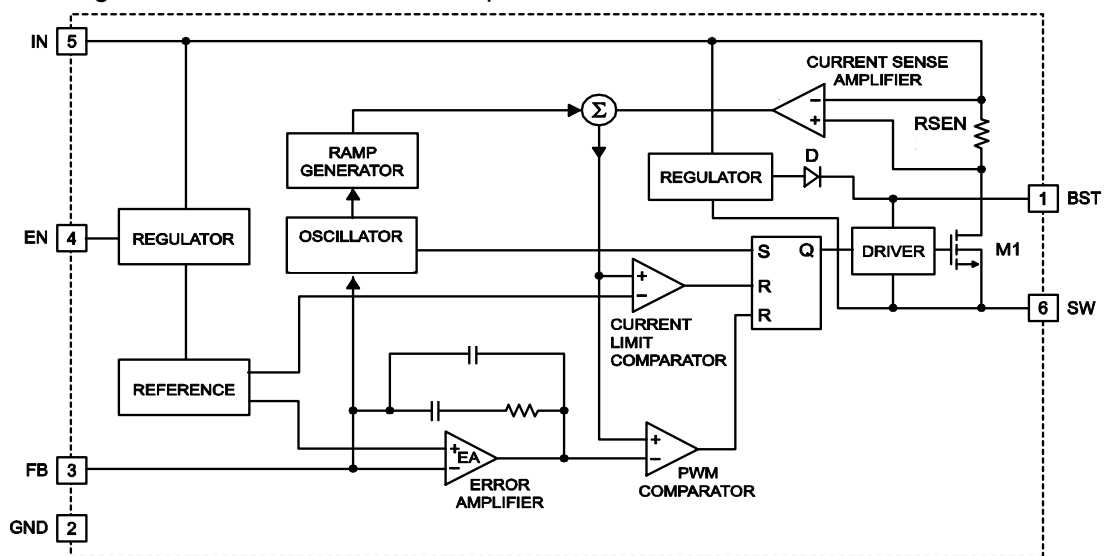

Figure 2: Functional Block Diagram of Buck Regulator

GATE DRIVER APPLICATIONS INFORMATION

VIN Input Voltage

The VIN pin supplies all power to the device. It must be properly bypassed with a capacitor to ground – see below for specific recommendations.

The normal operating range of VIN is between 5V and 60V.

VIN should never be allowed to exceed the absolute maximum ratings, even in a short term transient condition, or damage to the device may result. In some cases – especially where mechanical energy can turn a motor into a generator – it may be necessary to use some form of overvoltage protection, such as a TVS diode, between VIN and ground.

Component Selection

MOSFET selection

Correctly selecting the power MOSFETs used to drive a motor is crucial to designing a successful motor drive.

The first requirement is that the MOSFET must have a VDS breakdown voltage that is higher than the supply voltage. It is recommended that considerable margin – 10-15 volts - be added to prevent MOSFET damage from transient voltages that can be caused by parasitic inductances in the PCB layout and wiring. For example, for 24V power supply applications, MOSFETs having a breakdown voltage of 40V-60V minimum are recommended. More margin is desirable in high current applications, as the transients caused by parasitic inductances may be larger. Also, there are conditions like regenerative braking that can inject current back into the power supply; care must be taken that this does not cause an increase in the power supply voltage large enough to damage components.

The MOSFETs must be able to safely pass the current needed to run the motor. The highest current condition, which is normally when the motor is first started or stalled, needs to be supported. This is typically called the “stall current” of the motor.

Related to the current capability of the MOSFET is the $r_{ds(on)}$. This is the resistance of the MOSFET when it is in the fully “turned on” state. The MOSFET will dissipate power proportional to the $r_{ds(on)}$ and the motor current: $P=I^2R$. The $r_{ds(on)}$ needs to be selected so that for the desired motor current, the heat generated in this power can be safely dissipated. In some cases, this may require special PCB design considerations and/or external heatsinks to be used for the MOSFETs.

Some consideration should be made for the safe operating area (SOA) of the MOSFETs in fault conditions, such as a short circuit. The IC will act quickly in the event of a short, but there is still a very short time (on the order of 3 μ S) where large currents can flow in the MOSFETs while the protection circuits recognize the fault and disable the outputs.

External Capacitor Selection

The MP6535 has a unique feature in that it can provide a gate drive voltage (VREG) of 10-12V even if the input supply voltage drops as low as 5V. This gate drive voltage is generated by a charge pump inside the part, which uses external capacitors.

The charge pump flying capacitor, C_{CP} , should have a capacitance of 470nF. It needs to be rated to withstand the maximum VIN power supply voltage. An X7R or X5R ceramic capacitor is recommended. With a 470nF capacitor, VREG can output approximately 10mA when VIN is 5V. If operation below 10V is not needed, a 220nF capacitor can be used

To provide the large peak currents needed to turn on the HS MOSFET, bootstrap capacitors are used. These capacitors are charged when the output is driven low, then the charge in the bootstrap capacitor is used to turn on the HS MOSFET when the output is driven high. (Note that an internal charge pump will keep the bootstrap capacitor charged when the output is held high for an extended period).

The bootstrap capacitors are selected depending on the MOSFET total gate charge. When the HS MOSFET is turned on, the charge stored in the bootstrap capacitor is transferred to the HS MOSFET gate. As a simplified approximation,

the minimum bootstrap capacitance can be estimated as $C_{BOOT} > 8 \cdot Q_G$, where Q_G is the total gate charge of the MOSFET in nC, and C_{BOOT} is in nF. The bootstrap capacitors should not exceed 1 μ F, or they may cause improper operation at start-up.

For most applications, bootstrap capacitors between 0.1 μ F and 1 μ F, X5R or X7R ceramic, rated for 25V minimum, are recommended.

The VREG pin requires a bypass capacitor to ground of 10 μ F. This should be an X7R or X5R ceramic capacitor rated for 16V minimum.

VIN requires a bypass capacitor to ground, placed as close as possible to the device. At a minimum, a 0.1 μ F X5R or X7R ceramic capacitor, rated for the VIN voltage, is recommended.

Depending on the power supply impedance and the distance between the MOSFETs and the power supply, additional bulk capacitance is usually needed. Between 47 μ F and 470 μ F of low ESR electrolytic capacitors are typically used.

Dead Time Resistor Selection

During the transition between driving an output low and high, there is a short period when neither the HS nor LS MOSFET is turned on. This period, called “dead time”, is needed to prevent any overlap in conduction between HS and LS MOSFETs, which would effectively provide a short-circuit directly between the power supply and ground. This condition, referred to as “shoot-through”, causes large transient currents, and can destroy the MOSFETs.

Since motors are inductive by nature, once current is flowing in the motor, it cannot stop immediately, even if the MOSFETs are turned off. This “recirculation current” continues to flow in the original direction until the magnetic field has decayed.

When the MOSFETs are turned off, this current will flow through the “body diode” which is inherent in the MOSFET device.

MOSFET body diodes have a much higher voltage drop than the MOSFET has during conduction, so there more power dissipated in body diode conduction than during the on time. Because of this, it is desirable to minimize the dead time. However, the dead time must be

made large enough to guarantee under all conditions that the HS and LS MOSFETs are never turned on at the same time.

Dead time can be set over a large range, by selecting the value of the external resistor that is connected to the DT pin. Usually, a good starting point is a dead time of about 1 μ S, which requires a 200k resistor on the DT pin. If faster switching and/or a high PWM frequency (over ~30kHz) is used, shorter dead time may be desirable; if switching is slowed using external gate resistors, longer dead time may be needed.

The waveform below shows about a 300nS dead time between the LS gate turn-off and the HS gate turn-on.

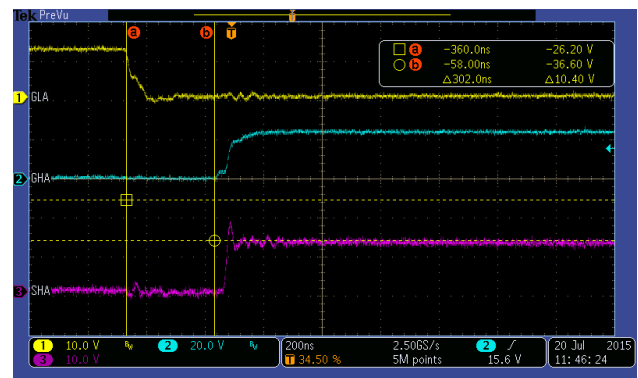

LSS Resistor Selection

If the voltage applied to the LSS pin ever exceeds 500mV, an overcurrent event will be recognized. The external sense resistor is sized to provide less than 500mV drop at the maximum expected motor current. For example, if a 50 m Ω resistor is used, a current of 10 amps would cause a 500mV drop, and activate the overcurrent protection.

If this function is not needed, connect LSS directly to ground.

OCREF Voltage Selection

An internal comparator compares the voltage drop across each MOSFET with a voltage that is externally provided on the OCREF input pin. This voltage is normally provided by an external resistor divider from a convenient power supply. If the drop across any MOSFET ever exceeds the voltage on the OCREF pin, a short-circuit event is recognized.

If this function is not needed, connect OCREF to VREG through a 100k resistor.

Gate Drive Considerations

The gate characteristics of the selected MOSFETs will affect how fast they will be switched and off. The gate drive outputs of the device can be connected directly to the gates of the power MOSFETs, which results in the fastest possible turn-on and turn-off times. However, it may be advantageous to add external components (resistors and/or diodes) to modify the MOSFET turn-on and turn-off characteristics.

Adding external series resistance – typically between 10 and 100 ohms – will limit the current that charges and discharges the gate of the MOSFET, which will slow down the turn-on and turn-off times. Sometimes this is desirable to control EMI and noise. Slowing the transition down too much, however, results in large power dissipation in the MOSFET during switching.

In some cases, it is desirable to have a slow turn-on, but a fast turn-off. This can be implemented by using a series resistor in parallel with a diode. At turn-on, the resistor limits the current flow into the gate; at turn-off, the gate is discharged quickly through the diode.

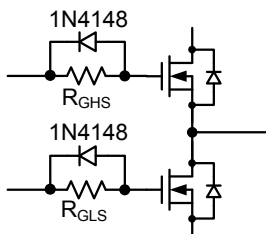

This waveform below shows the gates of the LS and HS MOSFETs, and the phase node (output) with no series resistance. You can see that the gates transition quickly. The resulting rise time on the phase node is quite fast. Note the scale of 100nS/div.

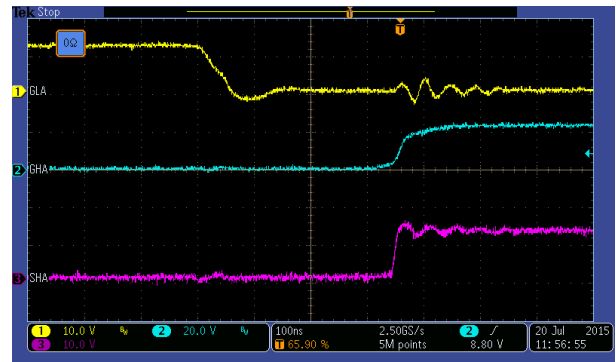

This waveform shows the effect of adding a 100Ω series resistor between the GLA and GLH pins and the MOSFET gates. Rise time on the phase node has been slowed significantly. The scale here is 200nS/div.

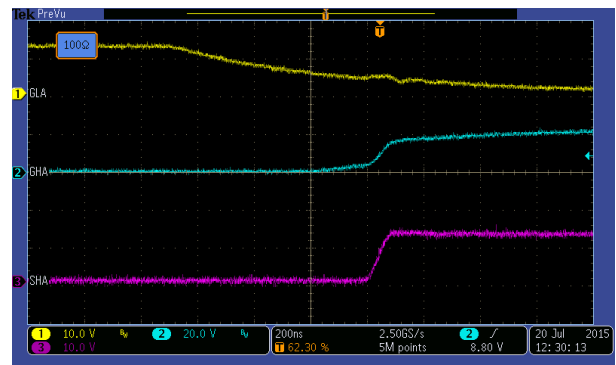

This waveform shows the effect of adding a 1N4148 diode in parallel with the 100Ω resistors (with the cathode connected to the IC). You can see that the fall time of the LS gate is quite fast compared to the HS gate rise time. The phase node moves even slower, because of a longer period of time between when the LS FET is turned off, and the HS FET is turned on.

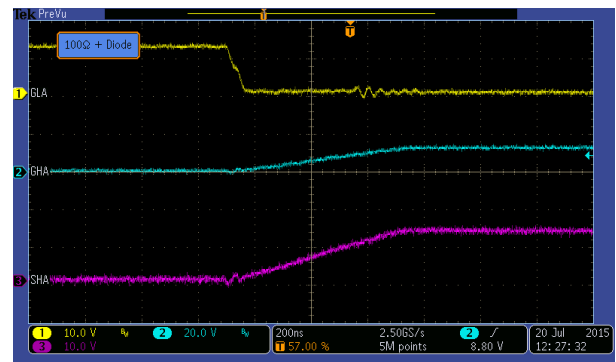

PCB Layout

Proper PCB layout is critical to the performance of MOSFET gate drivers. In particular, the connection between the HS source and LS drain needs to be as direct as possible, to avoid negative undershoot on the phase node due to parasitic inductances. The pre-driver is designed to accommodate negative undershoot, but if it is excessive, unpredictable operation or damage to the IC can result.

An example PCB layout (of the MP6530, which is similar to the MP6535) is shown below. It uses surface mount N-channel MOSFETs, which allows very short connection between the HS and LS MOSFETs. You can also see the use of wide copper areas for all of the high current paths.

The low-side sense resistor is composed of three resistors in parallel (R25, R26, and R27), and is connected to the input supply and LS MOSFET source terminals by wide copper areas.

Note the location of the charge pump and supply bypass capacitors, very close to the IC. The grounded side of these capacitors is connected to a ground plane, which is connected to the device ground pin and exposed pad. The high-current ground path between the input supply, input bulk capacitor C19, and MOSFETs is kept away from this area.

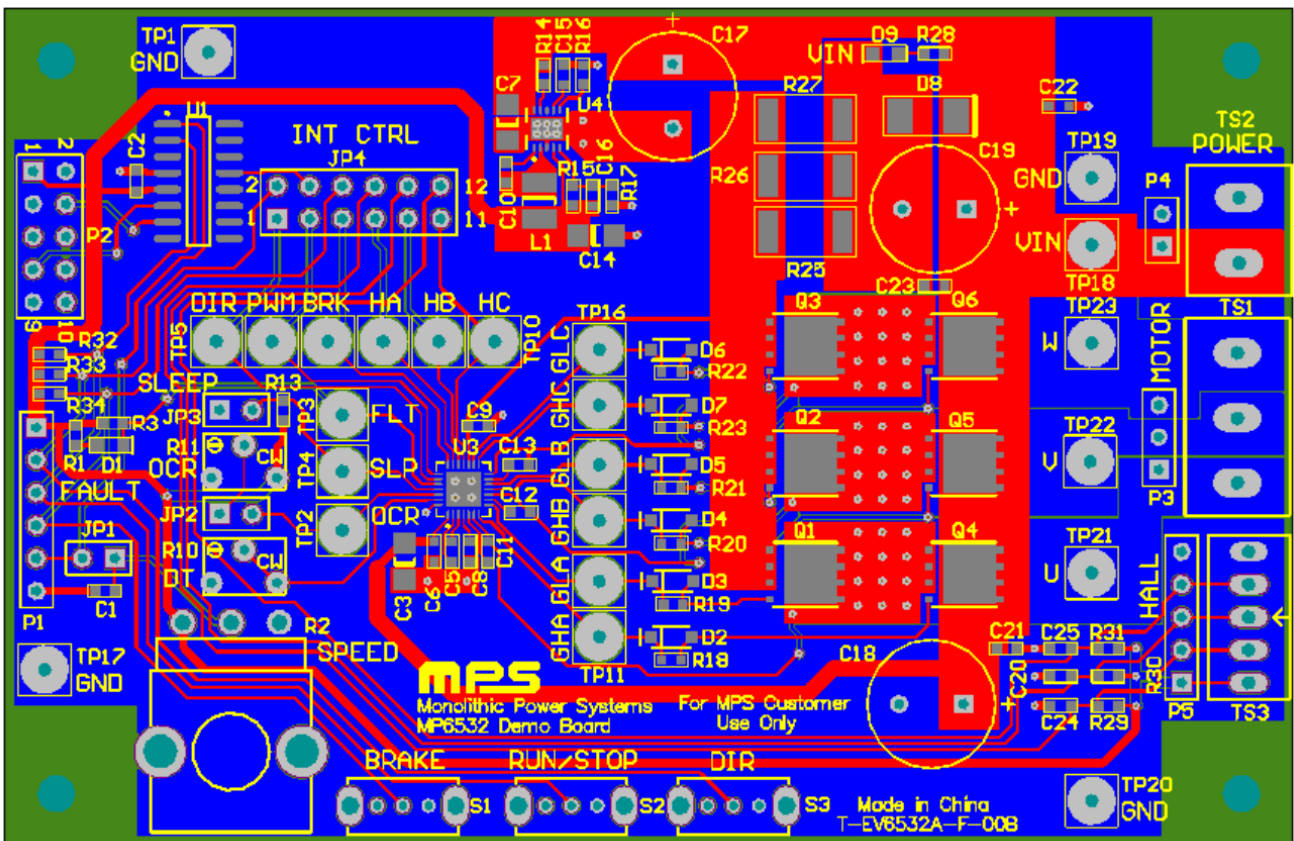

BUCK REGULATOR APPLICATION INFORMATION

Setting the Output Voltage

The external resistor divider sets the output voltage (see the Typical Application schematic). Table 3 lists resistors for common output voltages. The feedback resistor (R1) also sets the feedback loop bandwidth with the internal compensation capacitor (see Figure 2). R2 is:

$$R2 = \frac{R1}{\frac{V_{OUT}}{0.81V} - 1}$$

Table 3: Resistor Selection for Common Output Voltages

V _{OUT} (V)	R1 (kΩ)	R2 (kΩ)
1.8	80.6 (1%)	64.9 (1%)
2.5	49.9 (1%)	23.7 (1%)
3.3	49.9 (1%)	16.2 (1%)
5	49.9 (1%)	9.53 (1%)

Selecting the Inductor

Use an inductor with a DC current rating at least 25% percent higher than the maximum load current for most applications. For best efficiency, the inductor's DC resistance should be less than 200mΩ. For most designs, the required inductance value can be derived from the following equation.

$$L = \frac{V_{OUT} \times (V_{IN} - V_{OUT})}{V_{IN} \times \Delta I_L \times f_{SW}}$$

Where ΔI_L is the inductor ripple current.

Choose the inductor ripple current to be 30% of the maximum load current. The maximum inductor peak current is:

$$I_{L(MAX)} = I_{LOAD} + \frac{\Delta I_L}{2}$$

Under light-load conditions (below 100mA), use a larger inductance to improve efficiency.

Selecting the Input Capacitor

The input capacitor reduces the surge current drawn from the input supply and the switching noise from the device. The input capacitor impedance at the switching frequency should be less than the input source impedance to prevent high-frequency-switching current from passing through the input. Use ceramic capacitors with X5R or X7R dielectrics for their low ESRs and small temperature coefficients. For most applications, a 4.7μF capacitor will sufficient.

Selecting the Output Capacitor

The output capacitor keeps the output voltage ripple small and ensures feedback loop stability. The output capacitor impedance should be low at the switching frequency. Use ceramic capacitors with X5R or X7R dielectrics for their low ESR characteristics. For most applications, a 22μF ceramic capacitor will sufficient.

PCB Layout Guide

PCB layout is very important to stability. Please follow these guidelines.

- 1) Keep the path of switching current short and minimize the loop area formed by the input capacitor, high-side MOSFET, and Schottky diode.
- 2) Keep the connection from the power ground→Schottky diode→RSW pin as short and wide as possible.
- 3) Ensure all feedback connections are short and direct. Place the feedback resistors and compensation components as close to the chip as possible.
- 4) Route RSW away from sensitive analog nodes such as RFB.

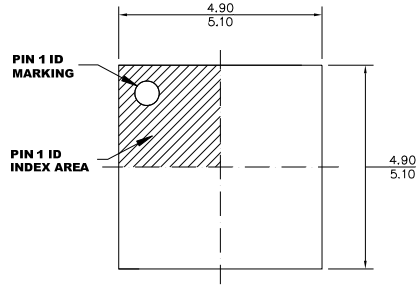
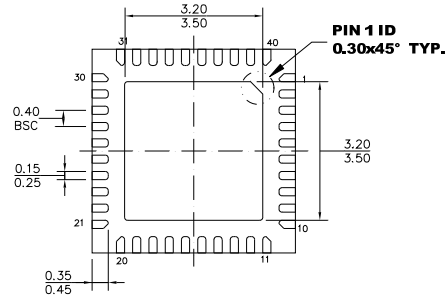
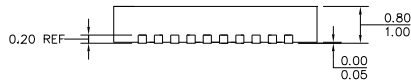
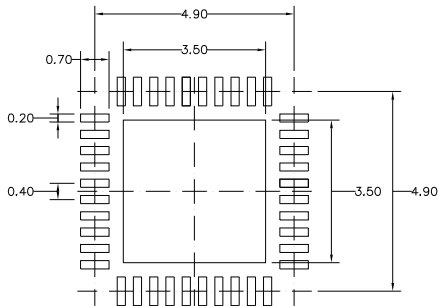
PACKAGE INFORMATION
QFN-40 (5mmX5mm)

TOP VIEW

BOTTOM VIEW

SIDE VIEW

RECOMMENDED LAND PATTERN
NOTE:

- 1) ALL DIMENSIONS ARE IN MILLIMETERS.**
- 2) EXPOSED PADDLE SIZE DOES NOT INCLUDE MOLD FLASH.**
- 3) LEAD COPLANARITY SHALL BE 0.08 MILLIMETERS MAX.**
- 4) DRAWING CONFIRMS TO JEDEC MO-220, VARIATION VHHE-1**
- 5) DRAWING IS NOT TO SCALE.**

NOTICE: The information in this document is subject to change without notice. Please contact MPS for current specifications. Users should warrant and guarantee that third party Intellectual Property rights are not infringed upon when integrating MPS products into any application. MPS will not assume any legal responsibility for any said applications.