

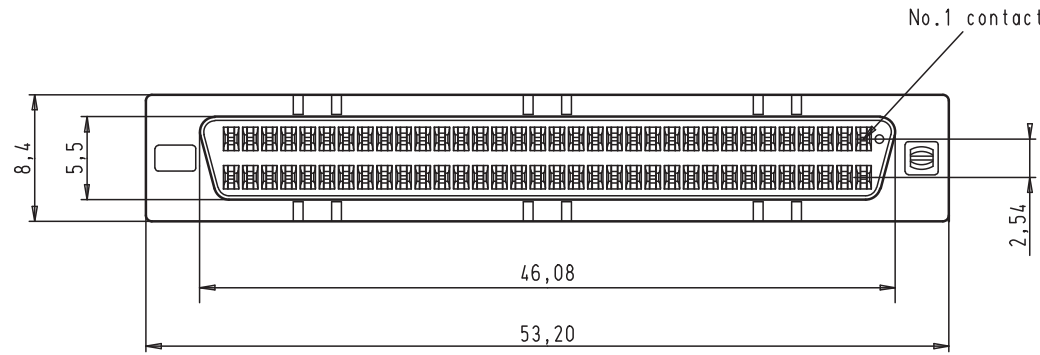

Alle Rechte vorbehalten. All rights reserved

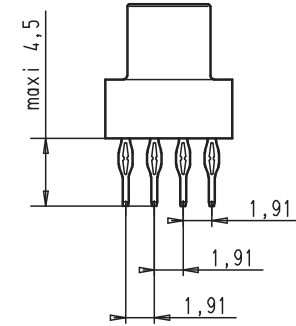

layout holes for PCB
1,6 to 3,2 thickness
68 poles
Components side

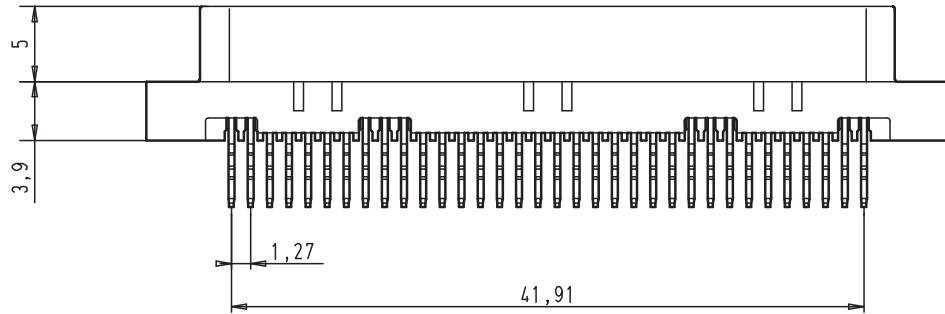
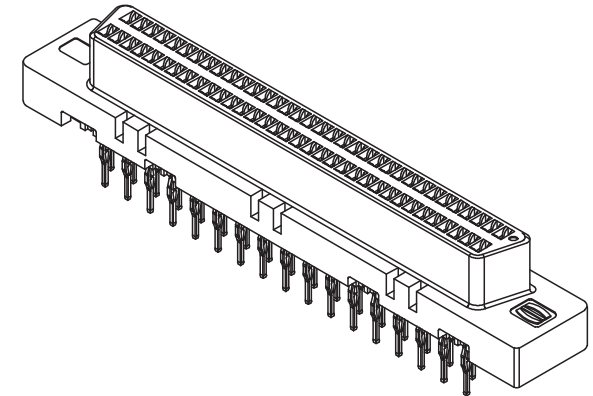
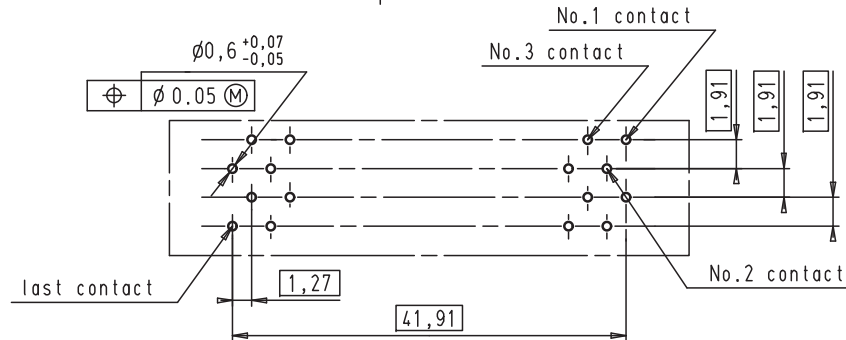

Mod.	Det.	Name	Det.	Name	 All Dim. in mm Orig. Size DIN A 3	har.mik® I/O pin/socket SCSI 3 68 poles har.press straight female connector plastic version	Meßstab/ Scale
			Detail.	27/05/98			jfb
27941	30-AUG-00	JB	Insp.				
26597	02-05-00	jfb	Stand.				
23297	04-06-99	jfb					
23225	27-05-98	jfb					
			HARTING EURL F-95972 Paris			TB 60 05 068 5322	Blatt/ Page 1 / 1
						Sub.	