

USB-Compliant Single-Cell Li-Ion Switching Charger with USB-OTG Boost for 200 mA to 1.45 A Systems



ON Semiconductor®

www.onsemi.com

FAN54005

Description

The FAN54005 is a highly integrated switch-mode charger, configurable for 200 mA to 1.45 A systems using a single external resistor.

The charging parameters and operating modes are programmable through an I²C Interface that operates up to 3.4 Mbps.

The charger and boost regulator circuits switch at 3 MHz to minimize the size of external passive components.

The FAN54005 provides battery charging in three phases: conditioning, constant current and constant voltage.

To ensure USB compliance and minimize charging time, the input current limit can be changed through the I²C interface by the host processor. Charge termination is determined by a programmable minimum current level. A safety timer with reset control provides a safety backup for the I²C host. Charge status is reported to the host through the I²C port.

The integrated circuit (IC) automatically restarts the charge cycle when the battery falls below an internal threshold. If the input source is removed, the IC enters a high-impedance mode, preventing leakage from the battery to the input. Charge current is reduced when the die temperature reaches 120°C, protecting the device and PCB from damage.

The FAN54005 can operate as a boost regulator on command from the system. The boost regulator includes a soft-start that limits inrush current from the battery and uses the same external components used for charging the battery.

Features

- Fully Integrated, High-Efficiency Charger for Single-Cell Li-Ion and Li-Polymer Battery Packs
- Charge Voltage Accuracy: $\pm 0.5\%$ at 25°C
 $\pm 1\%$ from 0 to 125°C
- Supports 200 mA to 1.45 A Systems
 - 95% Efficiency for 200 mA-Hour Batteries
 - 94% Efficiency for 500 mA-Hour Batteries
 - 90% Efficiency for 1.0 A-Hour Batteries
- $\pm 5\%$ Input Current Regulation Accuracy
- $\pm 5\%$ Charge Current Regulation Accuracy
- 20 V Absolute Maximum Input Voltage
- 6 V Maximum Input Operating Voltage

ORDERING INFORMATION

Part Number	Temperature Range	Package	PN Bits: IC_INFO[4:2]	Packing†
FAN54005UCX	-40°C to +85°C	20-Bump, Wafer-Level Chip-Scale Package (WLCSP), 0.4 mm Pitch, 1.96 x 1.87 mm	101	Tape and Reel

†For information on tape and reel specifications, including part orientation and tape sizes, please refer to our Tape and Reel Packaging Specifications Brochure, BRD8011/D.



1

WLCSP
20 BALL
CASE 567SL

- Charge Parameters Programmable through High-Speed I²C Interface (3.4 Mb/s) with Fast Mode Plus Compatibility
 - ♦ Input Current
 - ♦ Fast-Charge / Termination Current
 - ♦ Charger Voltage
 - ♦ Termination Enable
- 3 MHz Synchronous Buck PWM Controller with Wide Duty Cycle Range
- Small Footprint 1 μ H External Inductor
- Safety Timer with Reset Control
- 1.8 V Regulated Output from VBUS for Auxiliary Circuits
- Dynamic Input Voltage Control Automatically Reduces Charging Current with Weak Input Sources
- Low Reverse Leakage to Prevent Battery Drain to VBUS
- 5 V, 500 mA Boost Mode for USB OTG for 3.0 V to 4.5 V Battery Input
- Available in a 1.96 x 1.87 mm, 20-bump, 0.4 mm Pitch WLCSP Package

Applications

- Wireless Speakers, Headphones
- Cell Phones, Gaming Devices
- Toys, Drones, Digital Cameras
- IoT Devices
- E-Cigs, Vapes

FAN54005

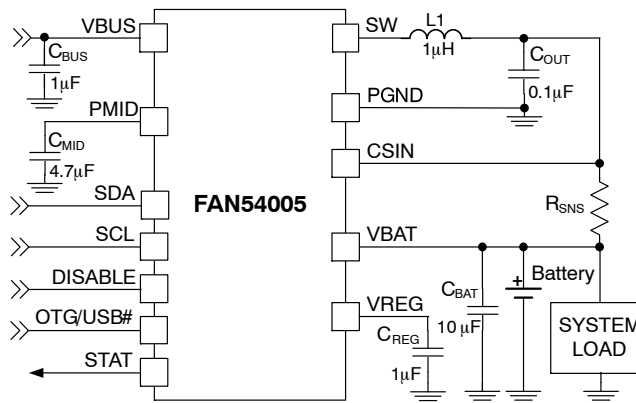

Figure 1. Typical Application

Block Diagram

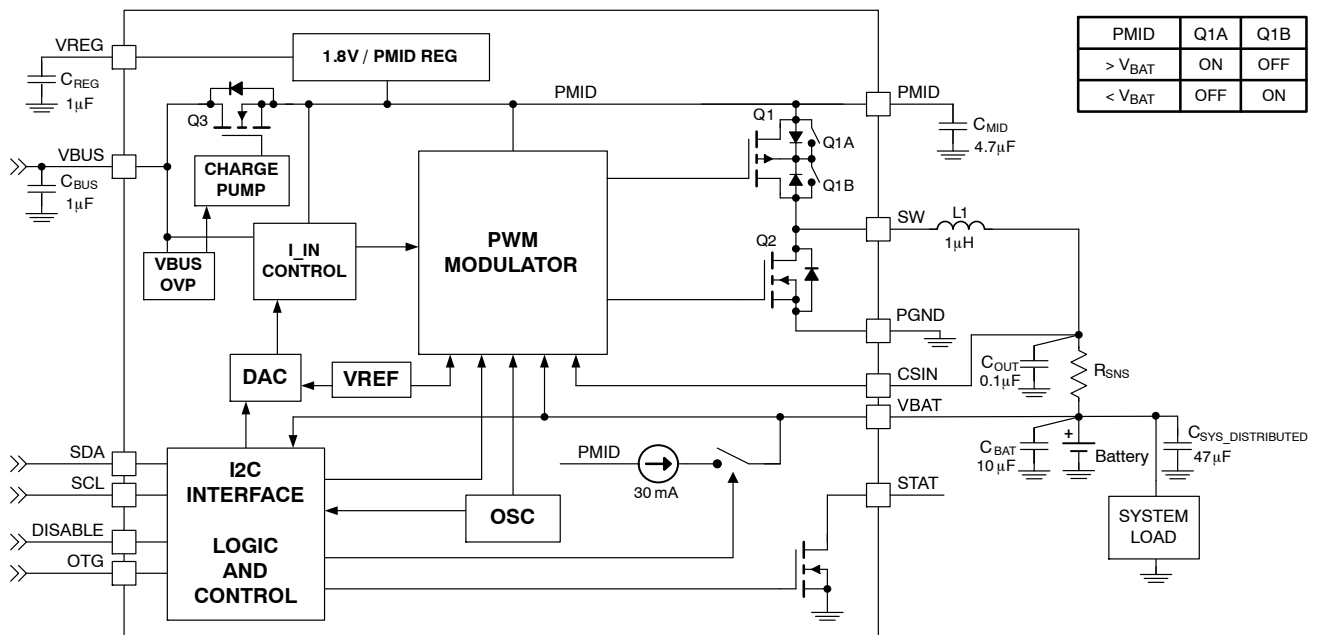

Figure 2. IC and System Block Diagram

Table 1. RECOMMENDED EXTERNAL COMPONENTS

Component	Description	Vendor	Parameter	Typ	Unit
L1	1 µH ±20%, 4.0 A, 33 mΩ, 2016	Semco CIGT201610EH1R0M	L	1.0	µH
C _{BAT}	10 µF, 20%, 6.3 V, X5R, 0603	Murata: GRM188R60J106M TDK: C1608X5R0J106M	C	10	µF
C _{MID}	4.7 µF, 10%, 10 V, X5R, 0603	Murata: GRM188R61A475K TDK: C1608X5R1A475K	C (Note 1)	4.7	µF
C _{BUS}	1.0 µF, 10%, 25 V, X5R, 0603	Murata: GRM188R61E105K TDK: C1608X5R1E105M	C	1.0	µF
C _{REG}	1.0 µF, 10%, 10 V, X5R, 0402	Murata: GRM155R61A105K TDK: C1005X5R1A105K	C	1.0	µF
C _{OUT}	0.1 µF, 10%, 16 V, X7R, 0402	Murata: GRM155R71C104K TDK: C1005X7R1C104K	C	0.1	µF
C _{SYS_DISTRIBUTED} (Note 2)	n/a	n/a	C	47	µF

1. A 10 V rating is sufficient for CMID because PMID is protected from over-voltage surges on VBUS by Q3 (Figure 2).

2. A minimum 47 µF of distributed capacitance on SYS is required for proper operation of the FAN54005.

FAN54005

Pin Configuration

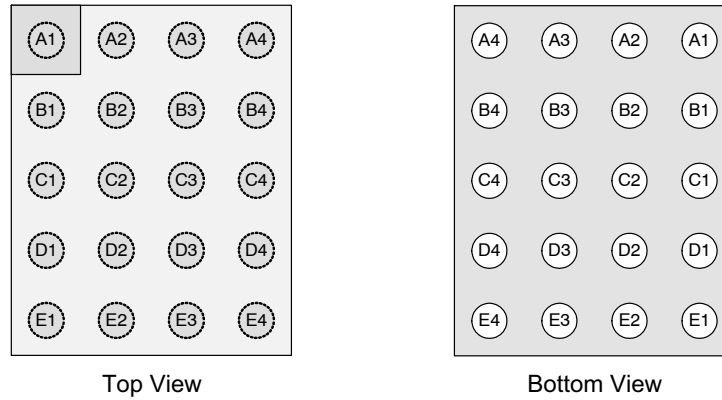

Figure 3. WLCSP-20 Pin Assignments

Table 2. PIN DEFINITIONS

Pin #	Name	Description
A1, A2	VBUS	Charger Input Voltage and USB-OTG output voltage. Bypass with a 1 μ F capacitor to PGND.
A3	NC	No Connect. No external connection is made between this pin and the IC's internal circuitry.
A4	SCL	I²C Interface Serial Clock. This pin should not be left floating.
B1-B3	PMID	Power Input Voltage. Power input to the charger regulator, bypass point for the input current sense, and high-voltage input switch. Bypass with a minimum of 4.7 μ F, 6.3 V capacitor to PGND.
B4	SDA	I²C Interface Serial Data. This pin should not be left floating.
C1-C3	SW	Switching Node. Connect to output inductor.
C4	STAT	Status. Open-drain output indicating charge status. The IC pulls this pin LOW when charging.
D1-D3	PGND	Power Ground. Power return for gate drive and power transistors. The connection from this pin to the bottom of C _{MID} should be as short as possible.
D4	OTG	On-The-Go. On VBUS Power-On Reset (POR), this pin sets the input current limit for t _{15MIN} charging. Also, the OTG pin enables the boost regulator in conjunction with OTG_EN and OTG_PL bits (See Table 21)
E1	CSIN	Current-Sense Input. Connect to the sense resistor in series with the battery. The IC uses this node to sense current into the battery. Bypass this pin close to R _{SNS} with a 0.1 μ F capacitor to PGND.
E2	DISABLE	Charge Disable. If this pin is HIGH, charging is disabled. When LOW, charging is controlled by the I ² C registers. When this pin is HIGH, the 15-minute timer is reset. This pin does not affect the 32-second timer.
E3	VREG	Regulator Output. Connect to a 1 μ F capacitor to PGND. This pin provides regulated 1.8 V and can supply up to 2 mA of DC load current.
E4	VBAT	Battery Voltage. Connect to the positive (+) terminal of the battery pack and close to R _{SNS} .

FAN54005

Table 3. ABSOLUTE MAXIMUM RATINGS

Symbol	Parameter		Min	Max	Unit
V _{BUS}	VBUS Voltage	Continuous	-0.7	20.0	V
		Pulsed, 100 ms Maximum Non-Repetitive	-1.0		
V _{STAT}	STAT Voltage		-0.3	16.0	V
V _I	PMID Voltage			7.0	V
	SW, CSIN, VBAT, DISABLE Voltage		-0.3 (Note 3)	7.0	
V _O	Voltage on Other Pins		-0.3	6.5 (Note 4)	V
dV _{BUS} / dt	Maximum V _{BUS} Slope above 5.5 V when Boost or Charger are Active			4	V/μs
-dV _{BUS} / dt	Negative VBUS Slew Rate during VBUS Short Circuit, C _{MID} ≤ 4.7 μF (See VBUS Short While Charging)	T _A ≤ 60°C		4	V/μs
		T _A ≥ 60°C		2	
ESD	Electrostatic Discharge Protection Level	Human Body Model per JESD22-A114	2000		V
		Charged Device Model per JESD22-C101	1000		
T _J	Junction Temperature		-40	+150	°C
T _{STG}	Storage Temperature		-65	+150	°C
T _L	Lead Soldering Temperature, 10 Seconds			+260	°C

Stresses exceeding those listed in the Maximum Ratings table may damage the device. If any of these limits are exceeded, device functionality should not be assumed, damage may occur and reliability may be affected.

3. SW only: Switching transients of -0.7 V, minimum, with duration <20 nsec, are acceptable.

4. Lesser of 6.5 V or V_I + 0.3 V

Table 4. RECOMMENDED OPERATING CONDITIONS

Symbol	Parameter	Min	Max	Unit
V _{BUS}	Supply Voltage	4	6	V
V _{BAT(MAX)}	Maximum Battery Voltage when Boost enabled		4.5	V
T _A	Ambient Temperature	-30	+85	°C
T _J	Junction Temperature (See Thermal Regulation and Protection section)	-30	+120	°C

Functional operation above the stresses listed in the Recommended Operating Ranges is not implied. Extended exposure to stresses beyond the Recommended Operating Ranges limits may affect device reliability.

Table 5. THERMAL PROPERTIES

Symbol	Parameter	Typical	Unit
θ _{JA}	Junction-to-Ambient Thermal Resistance	60	°C/W
θ _{JB}	Junction-to-PCB Thermal Resistance	20	°C/W

NOTE: Junction-to-ambient thermal resistance is a function of application and board layout. This data is measured with four-layer 2s2p boards in accordance to JEDEC standard JESD51. Special attention must be paid not to exceed junction temperature T_{J(max)} at a given ambient temperature T_A. For measured data, see Thermal Regulation and Protection.

FAN54005

Table 6. ELECTRICAL SPECIFICATIONS

Unless otherwise specified: according to the circuit of Figure 1; recommended operating temperature range for T_J and T_A ; $V_{BUS} = 5.0\text{ V}$; HZ_MODE; OPA_MODE = 0; (Charge Mode); SCL, SDA, OTG = 0 or 1.8 V; and typical values are for $T_J = 25^\circ\text{C}$.

Symbol	Parameter	Conditions	Min	Typ	Max	Unit
POWER SUPPLIES						
I_{VBUS}	VBUS Current	$V_{BUS} > V_{IN(MIN)1}$, PWM Switching		10		mA
		$V_{BUS} > V_{IN(MIN)1}$; PWM Enabled, Not Switching (Battery OVP Condition); I_IN Setting = 100 mA		2.5		mA
		$0^\circ\text{C} < T_J < 85^\circ\text{C}$, HZ_MODE = 1, 32S Mode		63	90	μA
I_{LKG}	VBAT to VBUS Leakage Current	$0^\circ\text{C} < T_J < 85^\circ\text{C}$, HZ_MODE = 1, $V_{BAT} = 4.2\text{ V}$, $V_{BUS} = 0\text{ V}$		0.2	5.0	μA
I_{BAT}	Battery Discharge Current in High-Impedance Mode	$0^\circ\text{C} < T_J < 85^\circ\text{C}$, HZ_MODE = 1, $V_{BAT} = 4.2\text{ V}$			10	μA
		DISABLE = 1, $0^\circ\text{C} < T_J < 85^\circ\text{C}$, $V_{BAT} = 4.2\text{ V}$			10	
CHARGER VOLTAGE REGULATION						
V_{OREG}	Charge Voltage Range		3.5		4.4	V
	Charge Voltage Accuracy	$T_A = 25^\circ\text{C}$	-0.5%		+0.5%	
		$T_J = 0\text{ to }125^\circ\text{C}$	-1%		+1%	
CHARGING CURRENT REGULATION						
$I_{OCHARGE}$	Output Charge Current Range	$V_{SHORT} < V_{BAT} < V_{OREG}$, $68 < R_{SNS} < 180\text{ m}\Omega$	200		1450	mA
	Charge Current Accuracy Across R_{SNS}	$20\text{ mV} \leq [V_{CSIN} - V_{BAT}] \leq 40\text{ mV}$	92	97	102	%
		$[V_{CSIN} - V_{BAT}] > 40\text{ mV}$	94	97	100	%
WEAK BATTERY DETECTION						
V_{LOWV}	Weak Battery Threshold Range		3.4		3.7	V
	Weak Battery Threshold Accuracy		-5		+5	%
	Weak Battery Deglitch Time	Rising Voltage		30		ms
LOGIC LEVELS: DISABLE, SDA, SCL, OTG						
V_{IH}	High-Level Input Voltage		1.05			V
V_{IL}	Low-Level Input Voltage				0.4	V
I_{IN}	Input Bias Current	Input Tied to GND or V_{BUS}		0.01	1.00	μA
CHARGE TERMINATION DETECTION						
I_{TERM}	Termination Current Range	$V_{BAT} > V_{OREG} - V_{RCH}$, $68 < R_{SNS} < 180\text{ m}\Omega$	20		400	mA
	Termination Current Accuracy	$[V_{CSIN} - V_{BAT}]$ from 3 mV to 20 mV	-25		+25	%
		$[V_{CSIN} - V_{BAT}]$ from 20 mV to 40 mV	-5		+5	
	Termination Current Deglitch Time			30		ms
1.8 V LINEAR REGULATOR						
V_{REG}	1.8 V Regulator Output	I_{REG} from 0 to 2 mA	1.7	1.8	1.9	V
INPUT POWER SOURCE DETECTION						
$V_{IN(MIN)1}$	VBUS Input Voltage Rising	To Initiate and Pass VBUS Validation		4.29	4.42	V
$V_{IN(MIN)2}$	Minimum VBUS During Charge	During Charging		3.71	3.94	V
t_{VBUS_VALID}	VBUS Validation Time			30		ms
DYNAMIC INPUT VOLTAGE CONTROL (V_{BUS})						
V_{SP}	DIVC Accuracy		-3		+3	%

FAN54005

Table 6. ELECTRICAL SPECIFICATIONS

Unless otherwise specified: according to the circuit of Figure 1; recommended operating temperature range for T_J and T_A ; $V_{BUS} = 5.0\text{ V}$; HZ_MODE ; $OPA_MODE = 0$; (Charge Mode); SCL , SDA , $OTG = 0$ or 1.8 V ; and typical values are for $T_J = 25^\circ\text{C}$.

Symbol	Parameter	Conditions	Min	Typ	Max	Unit
INPUT CURRENT LIMIT						
I_{INLIM}	Input Current Limit Threshold	I_{INLIM} Set to 100 mA	88	93	98	mA
		I_{INLIM} Set to 500 mA	450	475	500	
BATTERY RECHARGE THRESHOLD						
V_{RCH}	Recharge Threshold	Below V_{OREG}	100	120	150	mV
	Deglintch Time	V_{BAT} Falling Below V_{RCH} Threshold		130		ms
STAT OUTPUT						
$V_{STAT(OL)}$	STAT Output Low	$I_{STAT} = 10\text{ mA}$			0.4	V
$I_{STAT(OH)}$	STAT High Leakage Current	$V_{STAT} = 5\text{ V}$			1	μA
BATTERY DETECTION						
I_{DETECT}	Battery Detection Current before Charge Done (Sink Current) (Note 5)	Begins after Termination Detected and $V_{BAT} \leq V_{OREG} - V_{RCH}$		-0.80		mA
t_{DETECT}	Battery Detection Time			262		
SLEEP COMPARATOR						
V_{SLP}	Sleep-Mode Entry Threshold, $V_{BUS} - V_{BAT}$	$2.3\text{ V} \leq V_{BAT} \leq V_{OREG}$, V_{BUS} Falling	0	0.04	0.10	V
t_{SLP_EXIT}	Deglintch Time for V_{BUS} Rising Above V_{BAT} by V_{SLP}	Rising Voltage		30		ms
POWER SWITCHES (See Figure 2)						
$R_{DS(ON)}$	Q3 On Resistance (V_{BUS} to PMID)	$I_{INLIM} = 500\text{ mA}$		180	250	m Ω
	Q1 On Resistance (PMID to SW)			130	225	
	Q2 On Resistance (SW to GND)			150	225	
CHARGER PWM MODULATOR						
f_{SW}	Oscillator Frequency		2.7	3.0	3.3	MHz
D_{MAX}	Maximum Duty Cycle				100	%
D_{MIN}	Minimum Duty Cycle			0		%
I_{SYNC}	Synchronous to Non-Synchronous Current Cut-Off Threshold (Note 6)	Low-Side MOSFET (Q2) Cycle-by-Cycle Current Limit		140		mA
BOOST MODE OPERATION ($OPA_MODE = 1$, $HZ_MODE = 0$)						
V_{BOOST}	Boost Output Voltage at V_{BUS}	$2.5\text{ V} < V_{BAT} < 4.5\text{ V}$, I_{LOAD} from 0 to 200 mA	4.80	5.07	5.17	V
		$3.0\text{ V} < V_{BAT} < 4.5\text{ V}$, I_{LOAD} from 0 to 500 mA	4.77	5.07	5.17	
$I_{BAT(BOOST)}$	Boost Mode Quiescent Current	PFM Mode, $V_{BAT} = 3.6\text{ V}$, $I_{OUT} = 0$		140	300	μA
$I_{LIMPK(BST)}$	Q2 Peak Current Limit		1440	1700	1960	mA
$UVLO_{BST}$	Minimum Battery Voltage for Boost Operation	While Boost Active		2.30		V
		To Start Boost Regulator		2.50	2.70	
VBUS LOAD RESISTANCE						
R_{VBUS}	V_{BUS} to PGND Resistance	Normal Operation		1500		k Ω
		Charger Validation		100		Ω
PROTECTION AND TIMERS						
$V_{BUS(OVP)}$	V_{BUS} Over-Voltage Shutdown	V_{BUS} Rising	6.09	6.29	6.49	V
	Hysteresis	V_{BUS} Falling		100		mV

FAN54005

Table 6. ELECTRICAL SPECIFICATIONS

Unless otherwise specified: according to the circuit of Figure 1; recommended operating temperature range for T_J and T_A ; $V_{BUS} = 5.0\text{ V}$; HZ_MODE ; $OPA_MODE = 0$; (Charge Mode); $SCL, SDA, OTG = 0$ or 1.8 V ; and typical values are for $T_J = 25^\circ\text{C}$.

Symbol	Parameter	Conditions	Min	Typ	Max	Unit
PROTECTION AND TIMERS						
$I_{LIMPK(CHG)}$	Q1 Cycle-by-Cycle Peak Current Limit	Charge Mode		2.3		A
V_{SHORT}	Battery Short-Circuit Threshold	V_{BAT} Rising	1.95	2.00	2.05	V
	Hysteresis	V_{BAT} Falling		100		mV
I_{SHORT}	Linear Charging Current	$V_{BAT} < V_{SHORT}$	20	30	40	mA
$T_{SHUTDOWN}$	Thermal Shutdown Threshold (Note 7)	T_J Rising		145		$^\circ\text{C}$
	Hysteresis (Note 7)	T_J Falling		10		
T_{CF}	Thermal Regulation Threshold (Note 7)	Charge Current Reduction Begins		120		$^\circ\text{C}$
t_{INT}	Detection Interval			2.1		s
t_{32S}	32-Second Timer (Note 8)	Charger Enabled	20.5	25.2	28.0	s
		Charger Disabled	18.0	25.2	34.0	
t_{15MIN}	15-Minute Timer	15-Minute Mode	12.0	13.5	15.0	min
Δt_{LF}	Low-Frequency Timer Accuracy	Charger Inactive	-25		25	%

Product parametric performance is indicated in the Electrical Characteristics for the listed test conditions, unless otherwise noted. Product performance may not be indicated by the Electrical Characteristics if operated under different conditions.

5. Negative current is current flowing from the battery to GND (discharging the battery).
6. Q2 always turns on for 60 ns, then turns off if current is below I_{SYNC} .
7. Guaranteed by design; not tested in production.
8. This tolerance (%) applies to all timers on the IC, including soft-start and deglitching timers.

Table 7. I²C TIMING SPECIFICATIONS Guaranteed by design, $V_{BAT} \geq 2.5\text{ V}$ if valid V_{BUS} not present.

Symbol	Parameter	Conditions	Min	Typ	Max	Unit
f_{SCL}	SCL Clock Frequency	Standard Mode			100	kHz
		Fast Mode			400	
		High-Speed Mode, $C_B \leq 100\text{ pF}$			3400	
		High-Speed Mode, $C_B \leq 400\text{ pF}$			1700	
t_{BUF}	Bus-Free Time between STOP and START Conditions	Standard Mode		4.7		μs
		Fast Mode		1.3		
$t_{HD;STA}$	START or Repeated START Hold Time	Standard Mode		4		μs
		Fast Mode		600		ns
		High-Speed Mode		160		ns
t_{LOW}	SCL LOW Period	Standard Mode		4.7		μs
		Fast Mode		1.3		μs
		High-Speed Mode, $C_B \leq 100\text{ pF}$		160		ns
		High-Speed Mode, $C_B \leq 400\text{ pF}$		320		ns
t_{HIGH}	SCL HIGH Period	Standard Mode		4		μs
		Fast Mode		600		ns
		High-Speed Mode, $C_B \leq 100\text{ pF}$		60		ns
		High-Speed Mode, $C_B \leq 400\text{ pF}$		120		ns
$t_{SU;STA}$	Repeated START Setup Time	Standard Mode		4.7		μs
		Fast Mode		600		ns
		High-Speed Mode		160		ns

FAN54005

Table 7. I²C TIMING SPECIFICATIONS Guaranteed by design, $V_{BAT} \geq 2.5$ V if valid VBUS not present.

Symbol	Parameter	Conditions	Min	Typ	Max	Unit
$t_{SU;DAT}$	Data Setup Time	Standard Mode		250		ns
		Fast Mode		100		
		High-Speed Mode		10		
$t_{HD;DAT}$	Data Hold Time	Standard Mode	0		3.45	μ s
		Fast Mode	0		900	ns
		High-Speed Mode, $C_B \leq 100$ pF	0		70	ns
		High-Speed Mode, $C_B \leq 400$ pF	0		150	ns
t_{RCL}	SCL Rise Time	Standard Mode	20+0.1 C_B		1000	ns
		Fast Mode	20+0.1 C_B		300	
		High-Speed Mode, $C_B \leq 100$ pF		10	80	
		High-Speed Mode, $C_B \leq 400$ pF		20	160	
t_{FCL}	SCL Fall Time	Standard Mode	20+0.1 C_B		300	ns
		Fast Mode	20+0.1 C_B		300	
		High-Speed Mode, $C_B \leq 100$ pF		10	40	
		High-Speed Mode, $C_B \leq 400$ pF		20	80	
t_{RDA} t_{RCL1}	SDA Rise Time Rise Time of SCL after a Repeated START Condition and after ACK Bit	Standard Mode	20+0.1 C_B		1000	ns
		Fast Mode	20+0.1 C_B		300	
		High-Speed Mode, $C_B \leq 100$ pF		10	80	
		High-Speed Mode, $C_B \leq 400$ pF		20	160	
t_{FDA}	SDA Fall Time	Standard Mode	20+0.1 C_B		300	ns
		Fast Mode	20+0.1 C_B		300	
		High-Speed Mode, $C_B \leq 100$ pF		10	80	
		High-Speed Mode, $C_B \leq 400$ pF		20	160	
$t_{SU;STO}$	Stop Condition Setup Time	Standard Mode		4		μ s
		Fast Mode		600		ns
		High-Speed Mode		160		ns
C_B	Capacitive Load for SDA, SCL				400	pF

Timing Diagrams

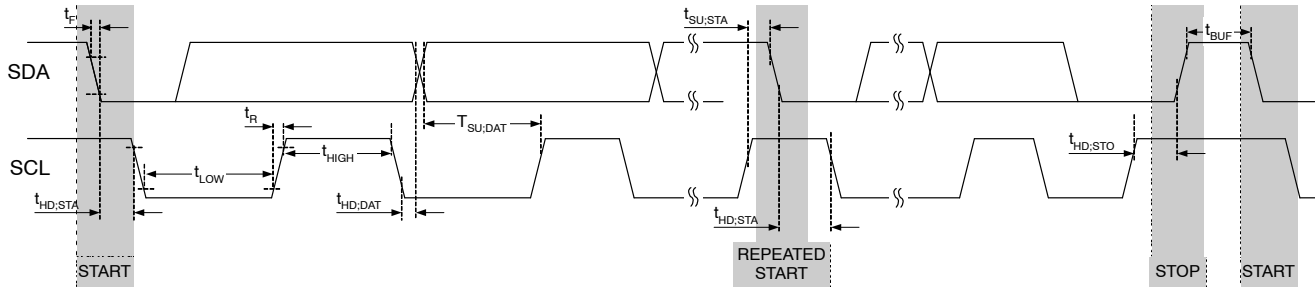
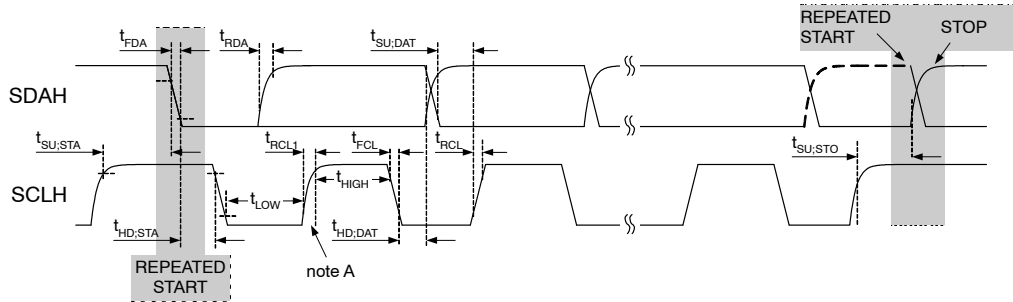



Figure 4. I²C Interface Timing for Fast and Slow Modes



-  = MCS Current Source Pull-up
-  = R_p Resistor Pull-up

Note A: First rising edge of SCLH after Repeated Start and after each ACK bit.

Figure 5. I²C Interface Timing for High-Speed Mode

Charge Mode Typical Characteristics

Unless otherwise specified, circuit of Figure 1, $R_{SNS} = 68\text{ m}\Omega$, $V_{OREG} = 4.2\text{ V}$, $V_{BUS} = 5.0\text{ V}$, and $T_A = 25^\circ\text{C}$.

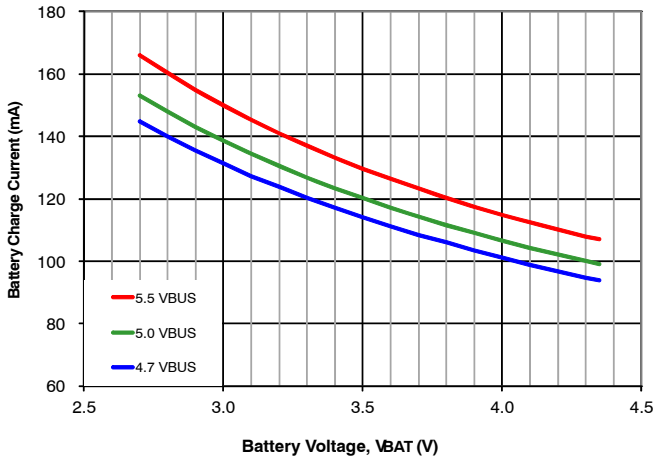

Figure 6. Battery Charge Current vs. V_{BUS} with $I_{INLIM}=100\text{ mA}$, $V_{OREG}=4.35\text{V}$

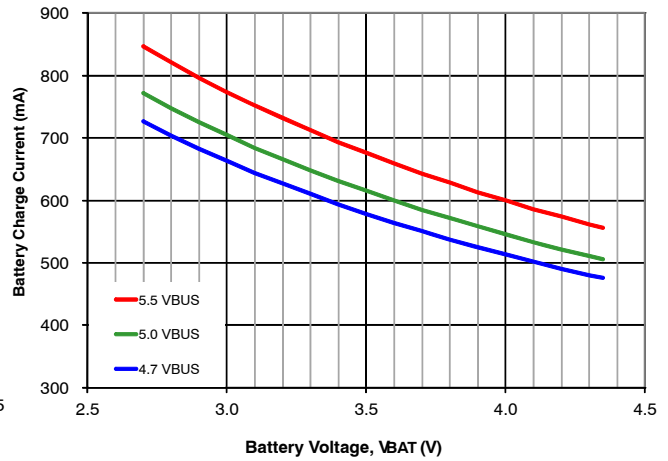

Figure 7. Battery Charge Current vs. V_{BUS} with $I_{INLIM}=500\text{ mA}$, $V_{OREG}=4.35\text{V}$

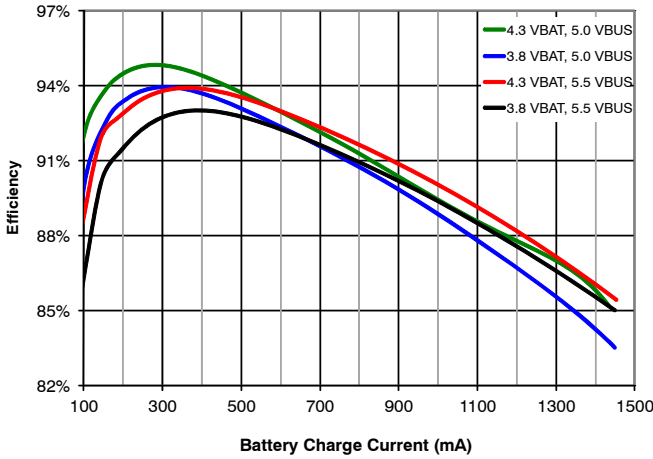

Figure 8. Charger Efficiency, No I_{INLIM} , $I_{OCHARGE}=1450\text{ mA}$

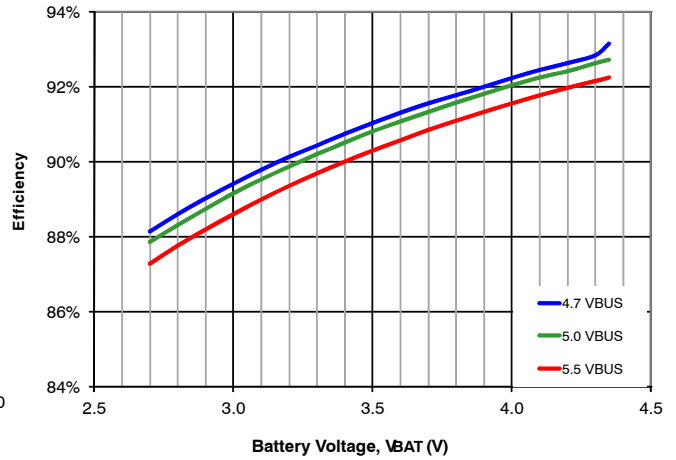

Figure 9. Charger Efficiency vs. V_{BUS} , $I_{INLIM}=500\text{ mA}$, $V_{OREG}=4.35$

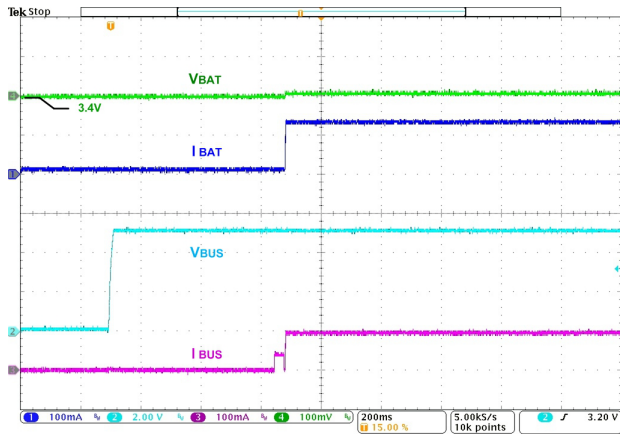

Figure 10. Auto-Charge Startup at V_{BUS} Plug-in, $OTG=0$, $V_{BAT}=3.4\text{ V}$

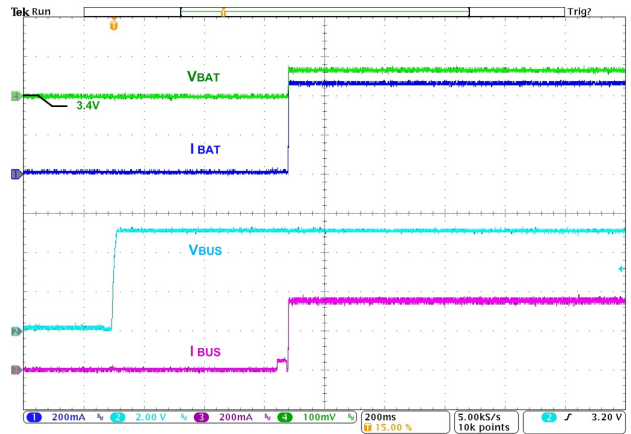

Figure 11. Auto-Charge Startup at V_{BUS} Plug-in, $OTG=1$, $V_{BAT}=3.4\text{ V}$

Charge Mode Typical Characteristics

Unless otherwise specified, circuit of Figure 1, $R_{SNS} = 68\text{ m}\Omega$, $V_{OREG} = 4.2\text{ V}$, $V_{BUS} = 5.0\text{ V}$, and $T_A = 25^\circ\text{C}$.

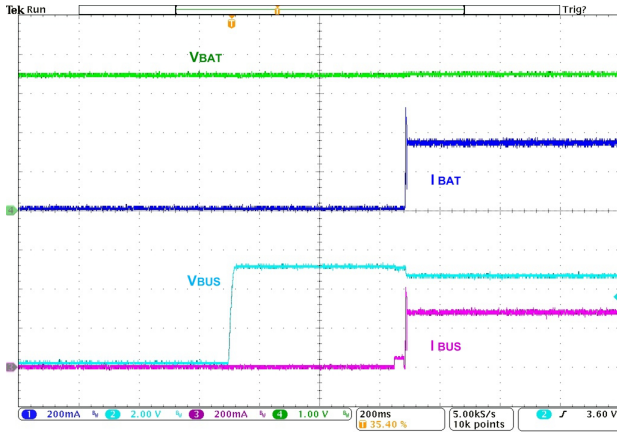

Figure 12. Auto-Charge Startup with 300 mA Limited Charger / Adaptor, OTG=1, $V_{BAT}=3.4\text{ V}$

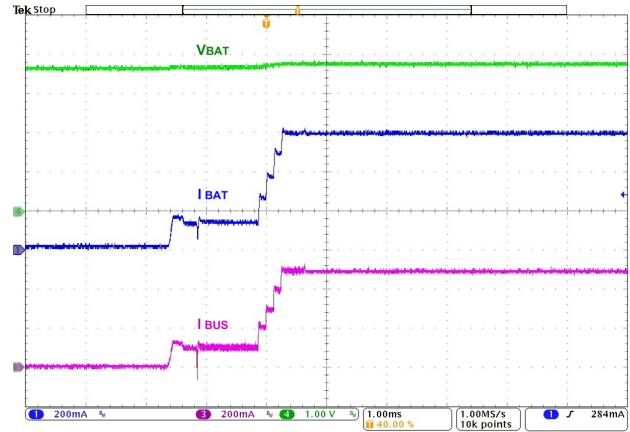

Figure 13. Charger Startup with HZ_MODE Bit Reset, $I_{INLIM}=500\text{ mA}$, $I_{OCHARGE}=1050\text{ mA}$, $V_{OREG}=4.2\text{ V}$, $V_{BAT}=3.6\text{ V}$

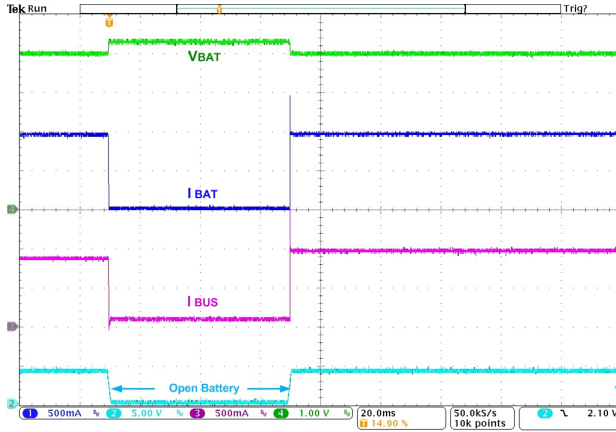

Figure 14. Battery Removal / Insertion During Charging, $V_{BAT}=3.9\text{ V}$, $I_{OCHARGE}=1050\text{ mA}$, No I_{INLIM} , $TE=0$

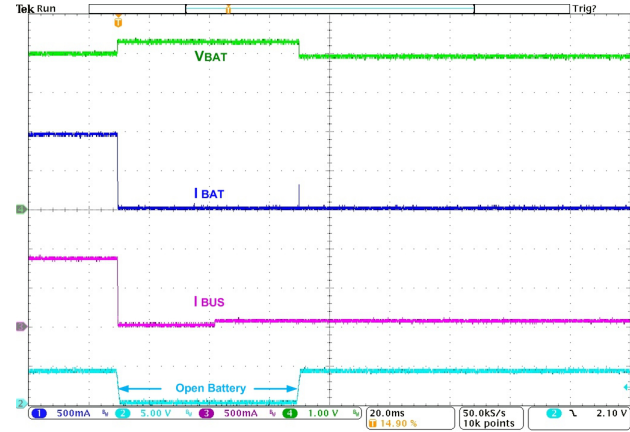

Figure 15. Battery Removal / Insertion During Charging, $V_{BAT}=3.9\text{ V}$, $I_{OCHARGE}=1050\text{ mA}$, No I_{INLIM} , $TE=1$

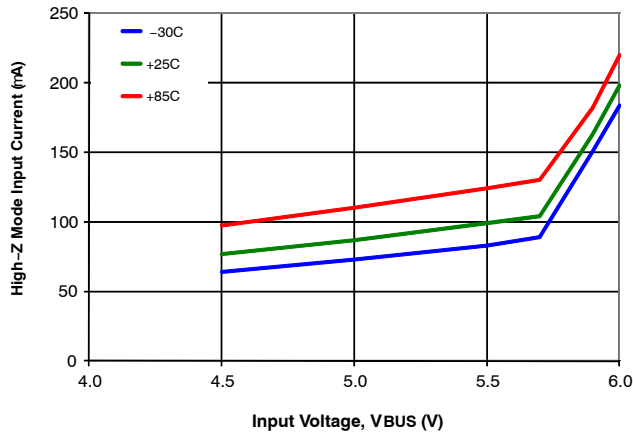

Figure 16. V_{BUS} Current in High-Impedance Mode with Battery Open

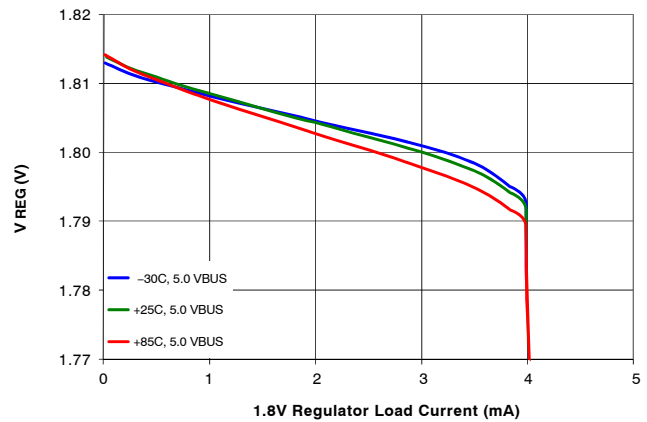

Figure 17. V_{REG} 1.8 V Output Regulation

Charge Mode Typical Characteristics

Unless otherwise specified, circuit of Figure 1, $R_{SNS} = 68\text{ m}\Omega$, $V_{OREG} = 4.2\text{ V}$, $V_{BUS} = 5.0\text{ V}$, and $T_A = 25^\circ\text{C}$.

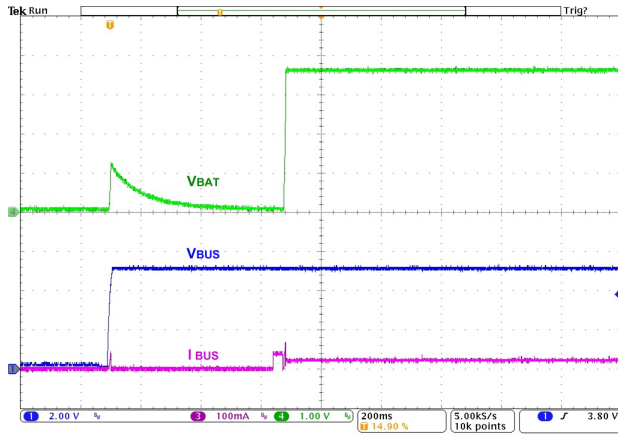

Figure 18. No Battery, TE=0, V_{BUS} Power Up

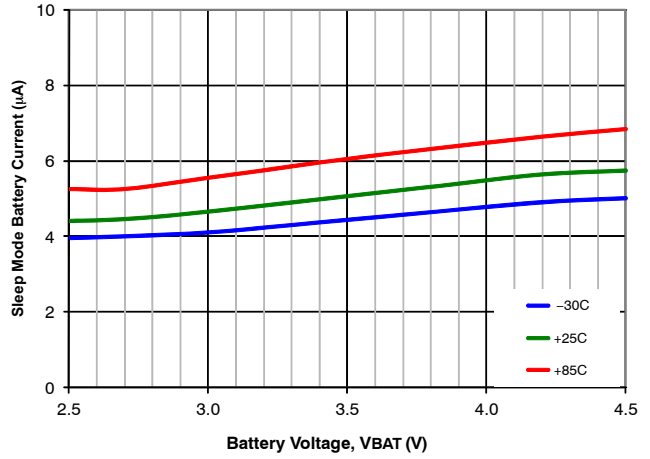

Figure 19. Sleep Mode Battery Discharge Current, SDA=SCL=0 V, VBUS Open

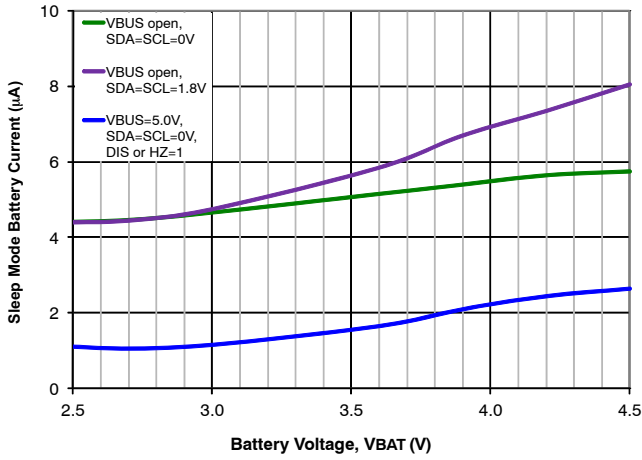

Figure 20. Battery Discharge Current vs. Mode

Boost Mode Typical Characteristics

Unless otherwise specified, circuit of Figure 1, $R_{SNS} = 68\text{ m}\Omega$, $V_{BAT} = 3.6\text{ V}$, and $T_A = 25^\circ\text{C}$.

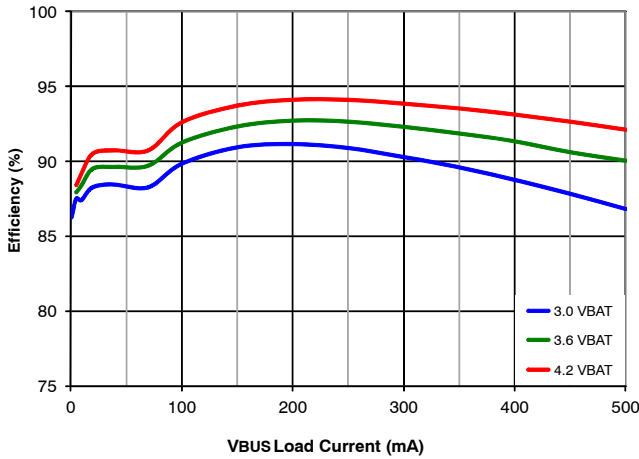

Figure 21. Efficiency vs. V_{BAT}

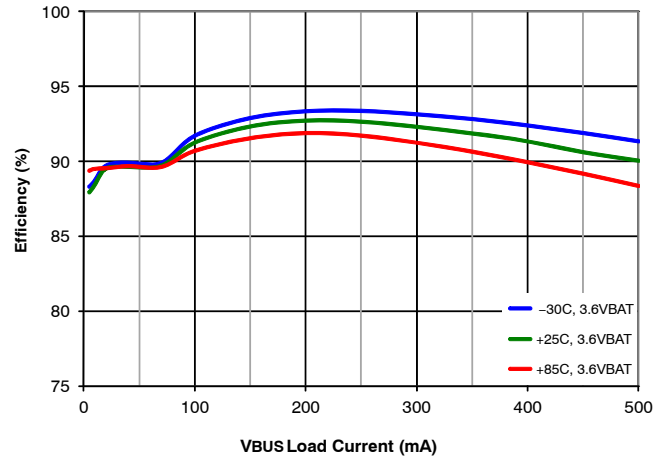

Figure 22. Efficiency Over-Temperature

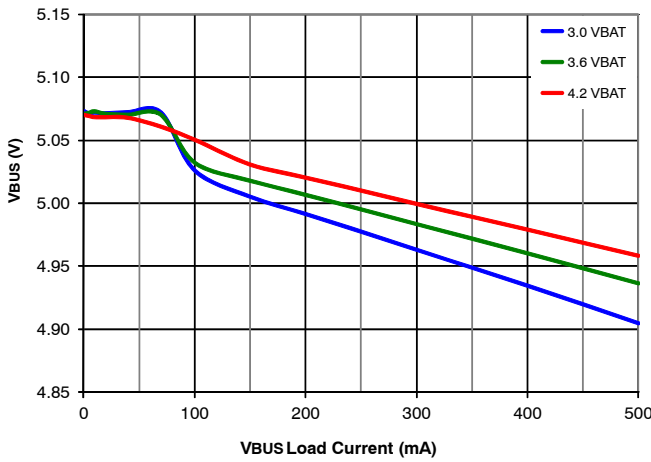

Figure 23. Output Regulation vs. V_{BAT}

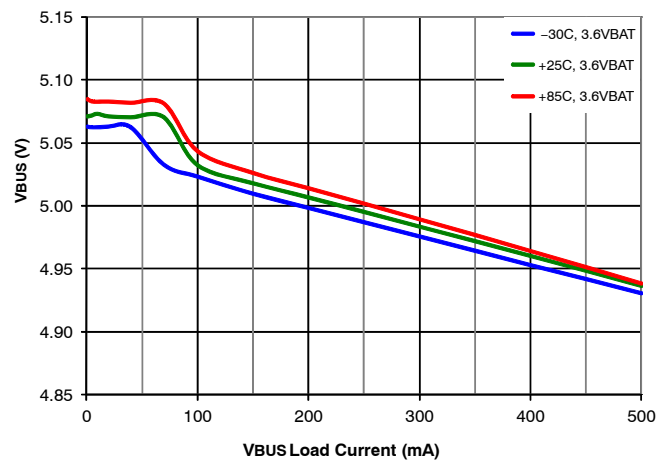

Figure 24. Output Regulation Over-Temperature

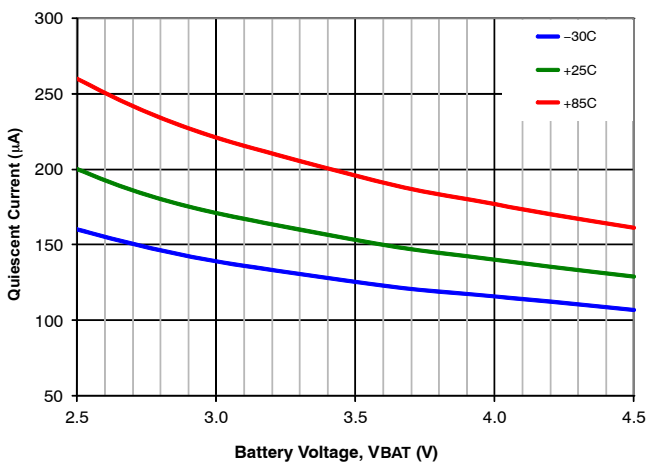

Figure 25. Quiescent Current

Boost Mode Typical Characteristics

Unless otherwise specified, circuit of Figure 1, $R_{SNS} = 68\text{ m}\Omega$, $V_{BAT} = 3.6\text{ V}$, and $T_A = 25^\circ\text{C}$.

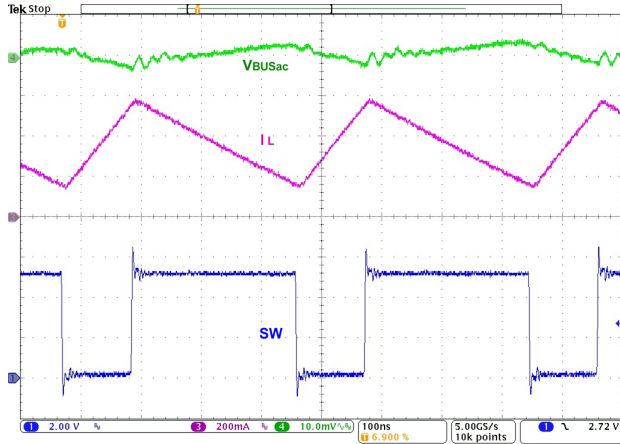

Figure 26. Boost PWM Waveform

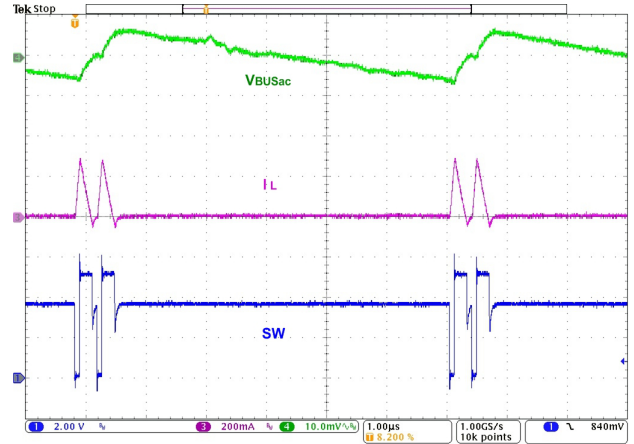

Figure 27. Boost PFM Waveform

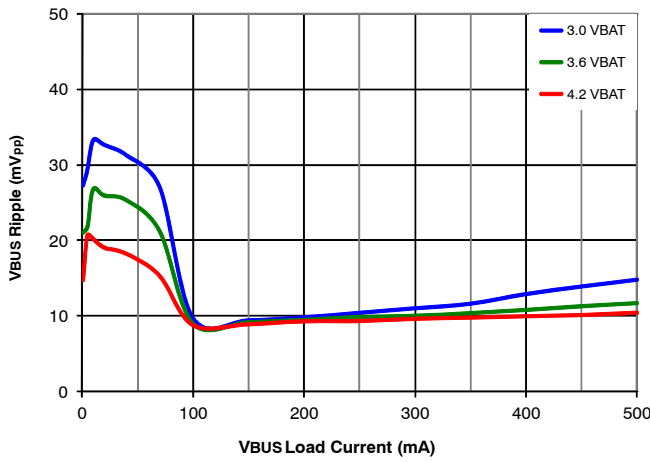

Figure 28. Output Ripple vs. V_{BAT}

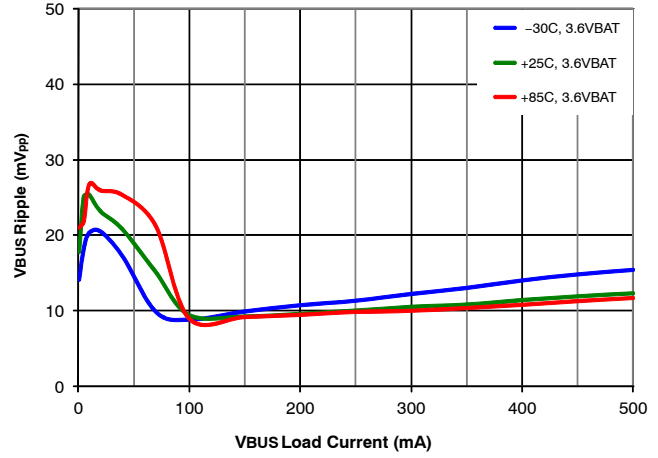

Figure 29. Output Ripple vs. Temperature

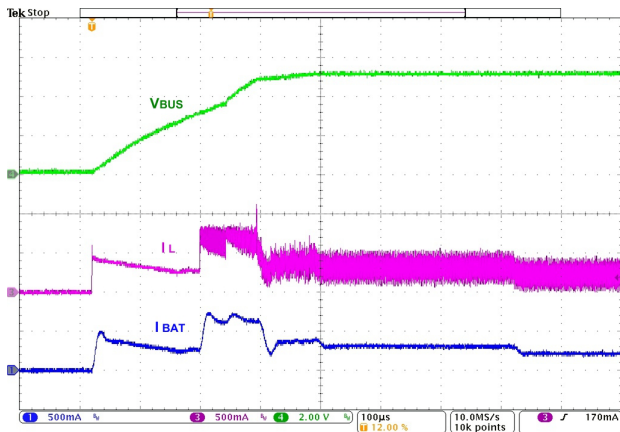

Figure 30. Startup, 3.6 V_{BAT} , $44\ \Omega$ Load, Additional $10\ \mu\text{F}$, X5R Across V_{BUS}

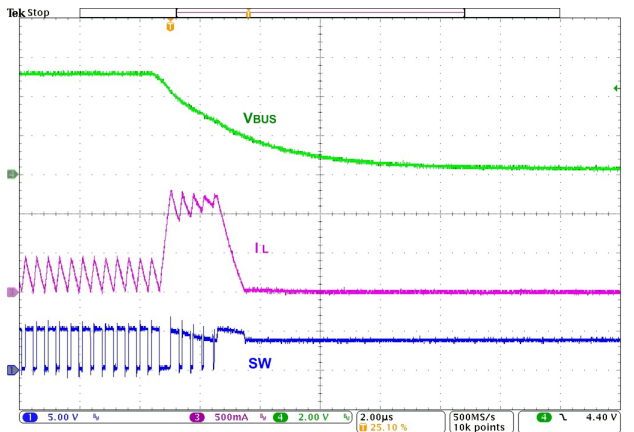

Figure 31. V_{BUS} Fault Response, 3.6 V_{BAT}

FAN54005

Boost Mode Typical Characteristics

Unless otherwise specified, circuit of Figure 1, $R_{SNS} = 68 \text{ m}\Omega$, $V_{BAT} = 3.6 \text{ V}$, and $T_A = 25^\circ\text{C}$.

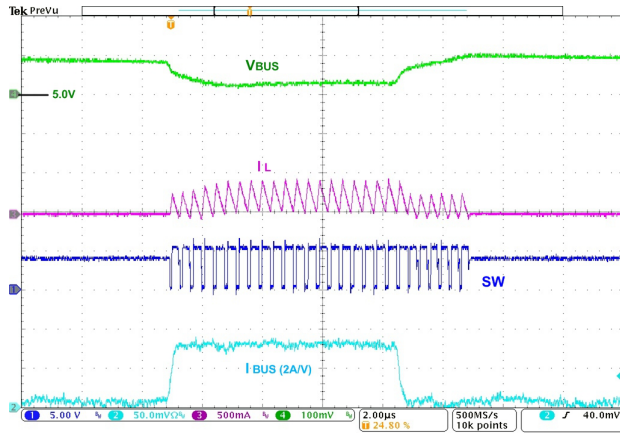

Figure 32. Load Transient, 5–155–5 mA, $t_R=t_F=100 \text{ ns}$

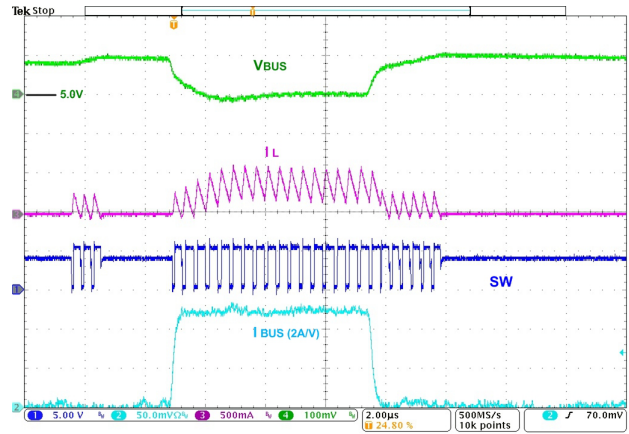

Figure 33. Load Transient, 5–255–5 mA, $t_R=t_F=100 \text{ ns}$

Circuit Description / Overview

When charging batteries with a current-limited input source, such as USB, a switching charger’s high efficiency over a wide range of output voltages minimizes charging time.

The FAN54005 combines a highly integrated synchronous buck regulator for charging with a synchronous boost regulator, which can supply 5 V to USB On-The-Go (OTG) peripherals. The FAN54005 employs synchronous rectification for both the charger and boost regulators to maintain high efficiency over a wide range of battery voltages and charge states.

The FAN54005 has three operating modes:

1. Charge Mode: Charges a single-cell Li-ion or Li-polymer battery.
2. Boost Mode: Provides 5 V power to USB-OTG with an integrated synchronous rectification boost regulator using the battery as input.
3. High-Impedance Mode: Both the boost and charging circuits are OFF in this mode. Current flow from VBUS to the battery or from the battery to VBUS is blocked in this mode. This mode consumes very little current from VBUS or the battery.

Charge Mode and Registers

Note: Default settings are denoted by **bold typeface**.

Charge Mode

In Charge Mode, FAN54005 employs four regulation loops:

1. Input Current: Limits the amount of current drawn from VBUS. This current is sensed internally and can be programmed through the I²C interface.
2. Charging Current: Limits the maximum charging current, which is sensed using an external R_{SNS}. Choose R_{SNS} to provide the desired I_{CHARGE} and I_{TERM} currents for your system, relative to the V_{RSNS} levels determined by the I_{CHARGE} and I_{TERM} register settings, as shown in Table 4 and Table 5, respectively.
3. Charge Voltage: The regulator is restricted from exceeding this voltage. As the internal battery voltage rises, the battery’s internal impedance and R_{SNS} work in conjunction with the charge voltage regulation to decrease the amount of current flowing to the battery. Battery charging is completed when the voltage across R_{SNS} drops below the threshold determined by I_{TERM}.
4. Temperature: If the IC’s junction temperature reaches 120°C, charge current is reduced until the IC’s temperature stabilizes at 120°C.
5. Dynamic Input Voltage Control (DIVC) limits the amount of drop on VBUS to a programmable voltage (V_{SP}) to accommodate incompatible adapters that limit current to a lower current than might be available from a “normal” USB adapter.

Battery Charging Curve

If the battery voltage is below V_{SHORT}, a linear current source pre-charges the battery until V_{BAT} reaches V_{SHORT}. The PWM charging circuit is then started and the battery is charged with a constant current if sufficient input power is available. The current slew rate is limited to prevent overshoot.

During the current regulation phase of charging, I_{INLIM} or the programmed charging current limits the amount of current available to charge the battery and power the system. The effect of I_{INLIM} on I_{CHARGE} can be seen in Figure 35.

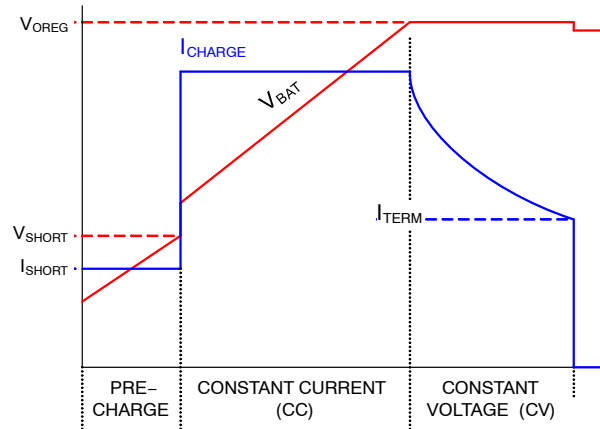

Figure 34. Charge Curve, I_{CHARGE} Not Limited by I_{INLIM}

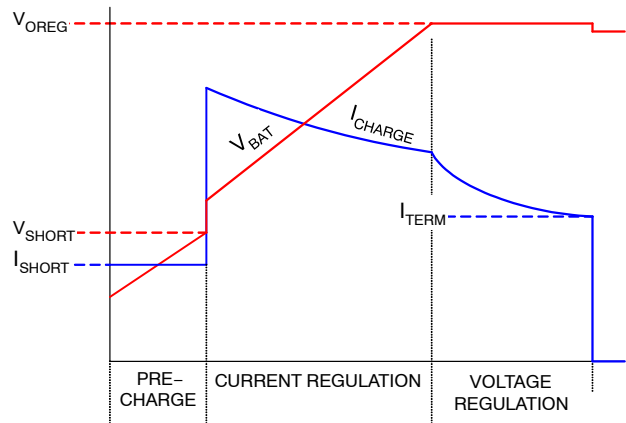

Figure 35. Charge Curve, I_{INLIM} Limits I_{CHARGE}

Assuming that V_{OREG} is programmed to the cell’s fully charged “float” voltage, the current that the battery accepts with the PWM regulator limiting its output (sensed at V_{BAT}) to V_{OREG} declines, and the charger enters the voltage regulation phase of charging. When the current declines to the programmed I_{TERM} value, the charge cycle is complete. Charge current termination can be disabled by resetting the TE bit (REG 01[3]).

The charger output or “float” voltage can be programmed by the OREG bits from 3.5 V to 4.44 V in 20 mV increments as shown in Table 8.

Table 8. OREG BITS (REG 02[7:2]) vs. CHARGER V_{OUT} (V_{OREG}) FLOAT VOLTAGE

Decimal	Hex	V _{OREG}	Decimal	Hex	V _{OREG}
OREG					
0	00	3.50	32	20	4.14
1	01	3.52	33	21	4.16
2	02	3.54	34	22	4.18
3	03	3.56	35	23	4.20
4	04	3.58	36	24	4.22
5	05	3.60	37	25	4.24
6	06	3.62	38	26	4.26
7	07	3.64	39	27	4.28
8	08	3.66	40	28	4.30
9	09	3.68	41	29	4.32
10	0A	3.70	42	2A	4.34
11	0B	3.72	43	2B	4.36
12	0C	3.74	44	2C	4.38
13	0D	3.76	45	2D	4.40
14	0E	3.78	46	2E	4.42
15	0F	3.80	47	2F	4.44
16	10	3.82	48	30	4.44
17	11	3.84	49	31	4.44
18	12	3.86	50	32	4.44
19	13	3.88	51	33	4.44
20	14	3.90	52	34	4.44
21	15	3.92	53	35	4.44
22	16	3.94	54	36	4.44
23	17	3.96	55	37	4.44
24	18	3.98	56	38	4.44
25	19	4.00	57	39	4.44
26	1A	4.02	58	3A	4.44
27	1B	4.04	59	3B	4.44
28	1C	4.06	60	3C	4.44
29	1D	4.08	61	3D	4.44
30	1E	4.10	62	3E	4.44
31	1F	4.12	63	3F	4.44

The following charging parameters can be programmed by the host through I²C:

Table 9. PROGRAMMABLE CHARGING PARAMETERS

Parameter	Name	Register
Output Voltage Regulation	V _{OREG}	REG 02[7:2]
Battery Charging Current Limit	I _{CHARGE}	REG 04[6:4]
Input Current Limit	I _{INLIM}	REG 01[7:6]
Charge Termination Limit	I _{TERM}	REG 04[2:0]
Weak Battery Voltage	V _{LOWV}	REG 01[5:4]

A new charge cycle begins when one of the following occurs:

- The battery voltage falls below V_{OREG} – V_{RCH}
- VBUS Power on Reset (POR)
- \overline{CE} or HZ_MODE is reset through I²C write to CONTROL1 (REG 01) register.

Charge Current Limit (I_{CHARGE})

Charge current limit is established by regulating the voltage across R_{SNS} (V_{RSNS}) to the value controlled by the IOCHARGE bits. Select R_{SNS} in the range of 68 mΩ < R_{SNS} < 180 mΩ.

Charge current is further limited by the IO_LEVEL (Reg 05[5]) bit by default (IO_LEVEL=1). When IOLEVEL=1, the voltage across R_{SNS} is limited to 34.0 mV. When IO_LEVEL=0 charge current is limited by the IOCHARGE bits.

Table 10. I_{CHARGE} CURRENT AS FUNCTION OF I_{CHARGE} (REG 04 [6:4]) BITS AND R_{SNS} VALUE

Decimal	HEX	V _{RSNS} (mV)	I _{CHARGE} Range (mA)	
			180 mΩ	68 mΩ
IOCHARGE				
0	00	37.4	208	550
1	01	44.2	246	650
2	02	51.0	283	750
3	03	57.8	321	850
4	04	71.4	397	1050
5	05	78.2	434	1150
6	06	91.8	510	1350
7	07	98.6	548	1450

Termination Current Limit

Current charge termination is enabled when TE (REG 01[3])=1.

Table 11. I_{TERM} CURRENT AS FUNCTION OF I_{TERM} BITS (REG 04[2:0]) AND R_{SNS} RESISTOR VALUES

Decimal	HEX	V _{RSNS} (mV)	I _{TERM} Range (mA)	
			180 mΩ	68 mΩ
I _{TERM}				
0	00	3.3	18	49
1	01	6.6	37	97
2	02	9.9	55	146
3	03	13.2	73	194
4	04	16.5	92	243
5	05	19.8	110	291
6	06	23.1	128	340
7	07	26.4	147	388

When the charge current falls below I_{TERM} , PWM charging stops and the STAT bits change to READY (00) for about 500 ms while the IC determines whether the battery and charging source are still connected. STAT then changes to CHARGE DONE (10), provided the battery and charger are still connected.

PWM Controller in Charge Mode

The IC uses a current-mode PWM controller to regulate the output voltage and battery charge currents. The synchronous rectifier (Q2) has a current limit that switches off the FET when the current is more negative than I_{SYNC} .

Charger Operation

V_{BUS} Plug In

When the IC detects that V_{BUS} has risen above $V_{IN(MIN)1}$ (4.4 V), the IC applies a 100 Ω load from V_{BUS} to GND. To clear the V_{BUS} Power-On-Reset (POR) and begin charging, V_{BUS} must remain above $V_{IN(MIN)1}$ and below V_{BUSOVP} for t_{VBUS_VALID} (30 ms) before the IC initiates charging.

The V_{BUS} validation sequence always occurs before charging is initiated or re-initiated (for example, after a V_{BUS} OVP fault or a V_{RCH} recharge initiation).

T_{VBUS_VALID} ensures that unfiltered 50 / 60 Hz chargers and other non-compliant chargers are rejected.

Safety Timer

Section references Figure 39.

At the beginning of charging, the IC starts a 15-minute timer (t_{15MIN}). When this times out, charging is terminated. Writing to any register through I²C stops and resets the t_{15MIN} timer, which in turn starts a 32-second timer (t_{32S}). Setting the TMR_RST bit (REG 00[7]) resets the t_{32S} timer. If the t_{32S} timer times out; charging is terminated, all registers (except Safety) are set to their default values, the FAULT bits are set to 110, STAT is pulsed HIGH and returns

LOW, and charging resumes using the default values with the t_{15MIN} timer running.

Normal charging is controlled by the host with the t_{32S} timer running to ensure that the host is alive. Charging with the t_{15MIN} timer running is used for charging that is unattended by the host. If the t_{15MIN} timer expires; the IC turns off the charger, sets the \overline{CE} bit, and indicates a timer fault (110) on the FAULT bits (REG 00[2:0]). This sequence prevents overcharge if the host fails to reset the t_{32S} timer.

USB-Friendly Boot Sequence

At V_{BUS} POR, the IC operates in accordance with its I²C register settings. If no registers have been written (including Safety, and the TMR_RST bit), typically due to an absence of host communication, the chargers input current limit is controlled by the OTG pin (100 mA if OTG is LOW and 500 mA if OTG is HIGH).

Once the host processor begins writing to the IC, charging parameters are set by the host, which must continually reset the t_{32S} timer to continue charging using the programmed charging parameters.

Input Current Limiting

To minimize charging time without overloading V_{BUS} current limitations, the IC's input current limit can be programmed by the IINLIM bits (REG 01[7:6]).

Table 12. INPUT CURRENT LIMIT

IINLIM REG 01[7:6]	Input Current Limit
00	100 mA
01	500 mA
10	800 mA
11	No limit

The OTG pin establishes the input current limit when t_{15MIN} is running.

Flow Charts

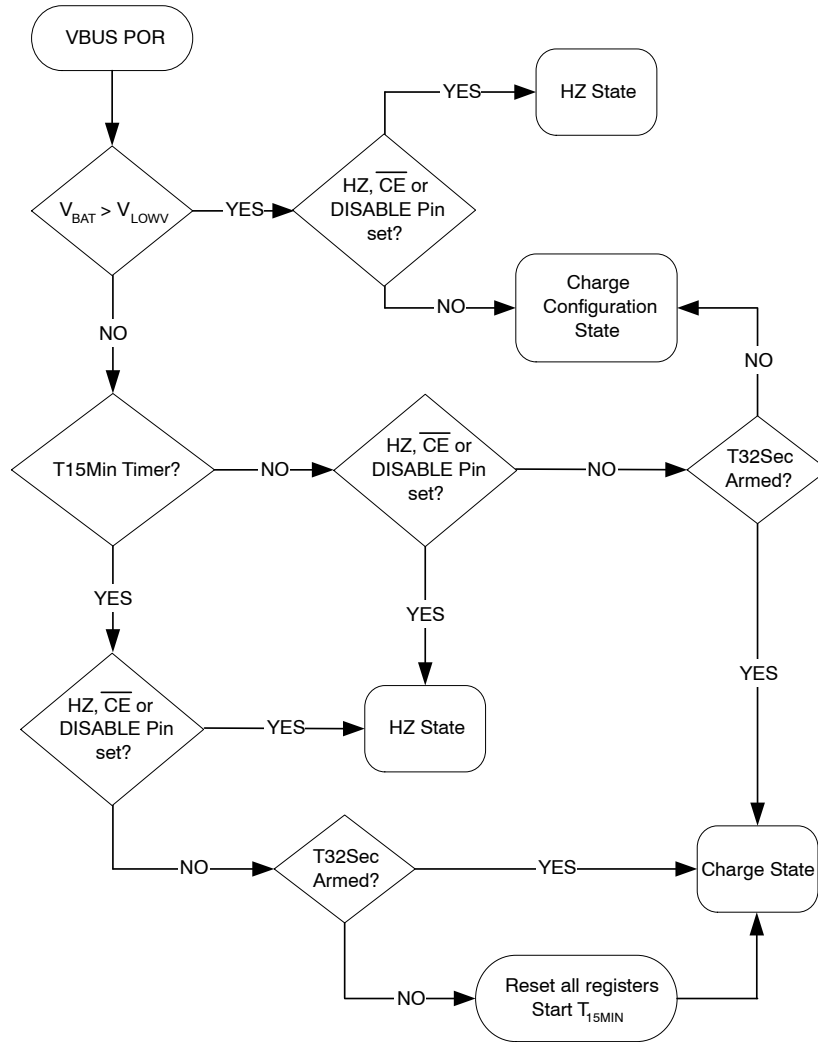

Figure 36. Charger VBUS POR

Flow Charts (Continued)

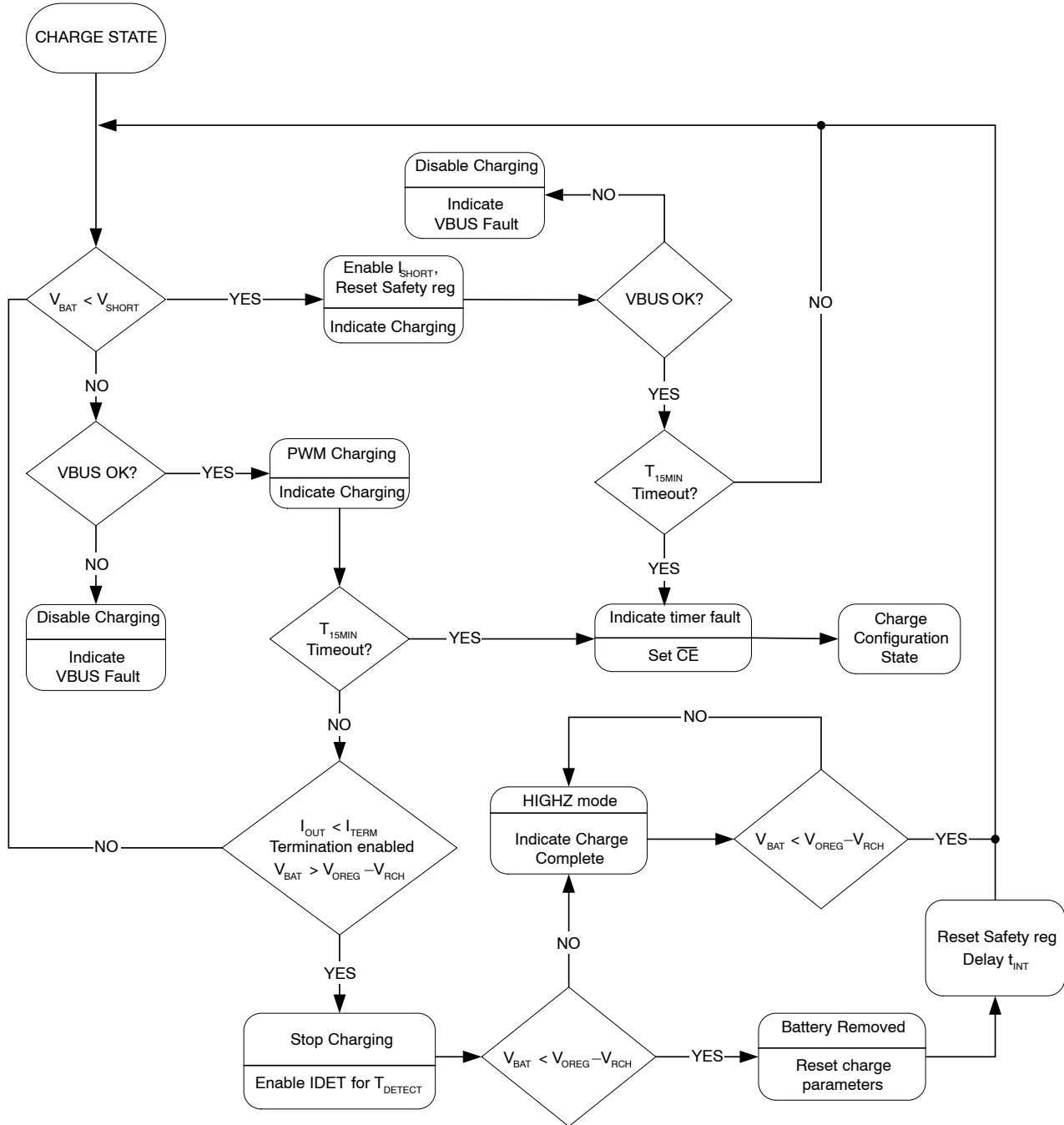

Figure 37. Charge Mode

FAN54005

Flow Charts (Continued)

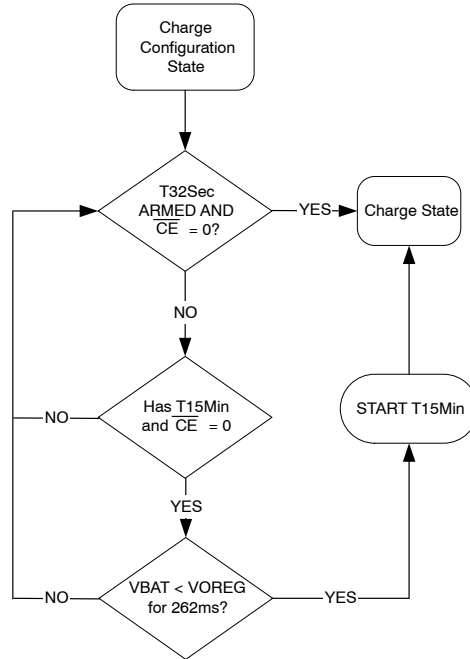

Figure 38. Charge Configuration

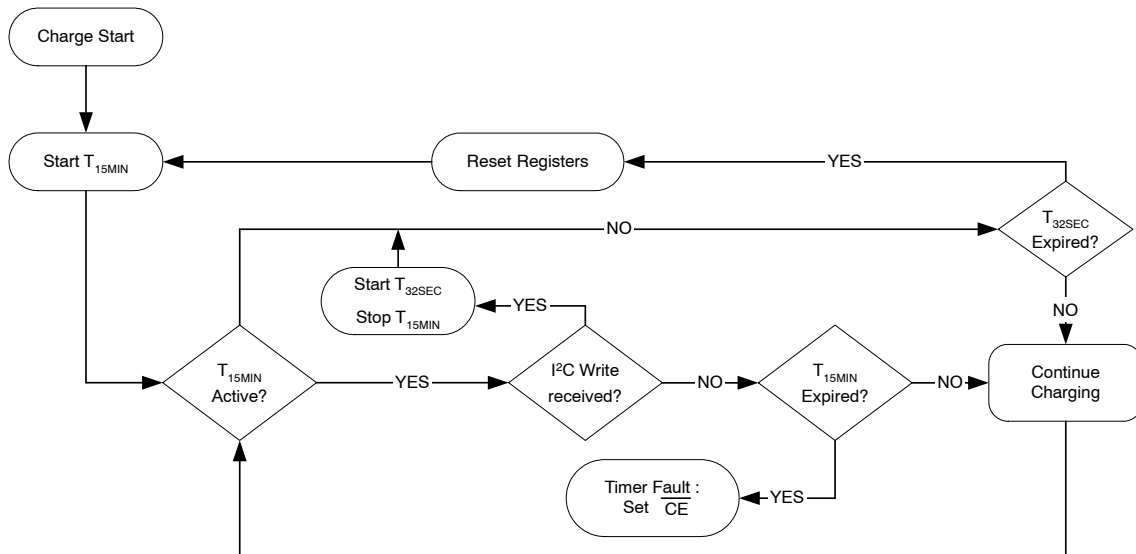

Figure 39. Timer Flow Chart

Dynamic Input Voltage Control

The FAN54005 has functionality that limits input current in case a current-limited incompatible adapter is supplying VBUS. These slowly increase the charging current until either:

- I_{NLIM} or $I_{OCHARGE}$ is reached
- or
- $V_{BUS} = V_{SP}$

If V_{BUS} collapses to V_{SP} when the current is ramping up, the FAN54005 charges with an input current that keeps $V_{BUS} = V_{SP}$. When the V_{SP} control loop is limiting the charge current, the SP bit (REG 05[4]) is set.

Table 13. V_{SP} AS FUNCTION OF VSP BITS (REG 05[2:0])

Decimal	HEX	V_{SP}
VSP		
0	00	4.213
1	01	4.293
2	02	4.373
3	03	4.453
4	04	4.533
5	05	4.613
6	06	4.693
7	07	4.773

Safety Settings

FAN54005 contain a SAFETY register (REG 06) that prevents the values in OREG (REG 02[7:2]) and IOCHARGE (REG 04[6:4]) from exceeding the values of the VSAFE and ISAFE values. Refer to Table 14 and Table 15 for details.

After V_{BAT} exceeds V_{SHORT} , the SAFETY register is loaded with its default value and may be written only before any other register is written. The entire desired Safety register value should be written twice to ensure the register bits are set. After writing to any other register, the SAFETY register is locked until V_{BAT} falls below V_{SHORT} .

The ISAFE (REG 06[6:4]) and VSAFE (REG 06[3:0]) registers establish the maximum values of V_{RSNS} and V_{OREG} used by the control logic. If the host attempts to write a value higher than VSAFE or ISAFE to OREG or IOCHARGE, respectively; the VSAFE, ISAFE value appears as the OREG, IOCHARGE register value, respectively.

Table 14. ISAFE (IOCHARGE Limit) AS FUNCTION OF ISAFE BITS (REG 06[6:4])

Decimal	HEX	V_{RSNS} (mV)	ISAFE Range (mA)	
			180 mΩ	68 mΩ
ISAFE				
0	00	37.4	208	550
1	01	44.2	246	650
2	02	51.0	283	750
3	03	57.8	321	850
4	04	71.4	397	1050
5	05	78.2	434	1150
6	06	91.8	510	1350
7	07	98.6	548	1450

Table 15. V_{SAFE} (V_{OREG} Max. Limit) AS FUNCTION OF VSAFE BITS (REG 06[3:0])

Decimal	HEX	Max. OREG (REG 02[7:2])	V_{OREG} Max. (V)
VSAFE			
0	00	100011	4.20
1	01	100100	4.22
2	02	100101	4.24
3	03	100110	4.26
4	04	100111	4.28
5	05	101000	4.30
6	06	101001	4.32
7	07	101010	4.34
8	08	101011	4.36
9	09	101100	4.38
10	0A	101101	4.40
11	0B	101110	4.42
12	0C	101111	4.44
13	0D	110000	4.44
14	0E	110001	4.44
15	0F	110010	4.44

Thermal Regulation and Protection

When the IC's junction temperature reaches T_{CF} (about 120°C), the charger reduces its output current to 37.4 mV/ R_{SNS} to prevent overheating. If the temperature increases beyond $T_{SHUTDOWN}$; charging is suspended, the FAULT bits are set to 101, and STAT is pulsed HIGH. In Suspend Mode, all timers stop and the state of the IC's logic is preserved. Charging resumes at programmed current after the die cools to about 120°C.

Additional θ_{JA} data points, measured using the FAN54005 evaluation board, are given in Table 16 (measured with $T_A=25^\circ\text{C}$). Note that as power dissipation increases, the effective θ_{JA} decreases due to the larger difference between the die temperature and ambient.

Table 16. EVALUATION BOARD MEASURED θ_{JA}

Dissipation (W)	θ_{JA}
0.504	54°C/W
0.844	50°C/W
1.506	46°C/W

Charge Mode Input Supply Protection

Sleep Mode

When V_{BUS} falls below $V_{BAT} + V_{SLP}$ and V_{BUS} is above $V_{IN(MIN)1}$, the IC enters Sleep Mode to prevent the battery from draining into VBUS. During Sleep Mode, reverse current is disabled by body switching Q1.

Input Supply Low-Voltage Detection

The IC continuously monitors VBUS during charging. If V_{BUS} falls below $V_{IN(MIN)2}$, the IC:

1. Terminates charging
2. Pulses the STAT pin, sets the STAT bits to 11, and sets the FAULT bits to 011.

If V_{BUS} recovers above the $V_{IN(MIN)1}$ rising threshold after time t_{INT} (about two seconds), the charging process is repeated. This function prevents the USB power bus from collapsing or oscillating when the IC is connected to a suspended USB port or a low-current-capable OTG device.

Input Over-Voltage Detection

When V_{BUS} exceeds $VBUS_{OVP}$, the IC:

1. Turns off Q3
2. Suspends charging
3. Sets the FAULT bits to 001, sets the STAT bits to 11, and pulses the STAT pin.

When V_{BUS} falls about 100 mV below $VBUS_{OVP}$, the fault is cleared and charging resumes after V_{BUS} is revalidated.

VBUS Short While Charging

If VBUS is shorted with a very low impedance while the IC is charging with $I_{INLIMIT}=100$ mA, the IC may not meet datasheet specifications until power is removed. To trigger this condition, V_{BUS} must be driven from 5 V to GND with a high slew rate. Achieving this slew rate requires a 0 Ω short from GND to the USB cable that is less than 10 cm from the connector.

Charge Mode Battery Detection & Protection

VBAT Over-Voltage Protection

The OREG voltage regulation loop prevents V_{BAT} from overshooting the OREG voltage by more than 50 mV when the battery is removed. When the PWM charger runs with no battery, the TE bit is not set, and a battery is inserted that is charged to a voltage higher than V_{OREG} ; PWM pulses stop. If no further pulses occur for 30 ms, the IC sets the FAULT bits to 100, sets the STAT bits to 11, and pulses the STAT pin.

Battery Detection during Charging

The IC can detect the presence, absence, or removal of a battery if the termination bit (TE) is set. During normal charging, once V_{BAT} is close to V_{OREG} and the termination charge current is detected, the IC terminates charging and sets the STAT bits to 10. It then turns on a discharge current, I_{DETECT} , for t_{DETECT} . If V_{BAT} is still above $V_{OREG} - V_{RCH}$, the battery is present and the IC sets the FAULT bits to 000.

If V_{BAT} is below $V_{OREG} - V_{RCH}$, the battery is absent and the IC:

1. Sets the registers to their default values.
2. Sets the FAULT bits to 111.
3. Resumes charging with default values after t_{INT} .

Battery Short-Circuit Protection

If the battery voltage is below the short-circuit threshold (V_{SHORT}); a linear current source, I_{SHORT} , supplies V_{BAT} until $V_{BAT} > V_{SHORT}$.

System Operation with No Battery

The FAN54005 continues charging after VBUS POR with the default parameters, regulating the V_{BAT} line to 3.54 V until the host processor issues commands or the t_{15MIN} timer expires. In this way, the FAN54005 can start the system without a battery.

The FAN54005 soft-start function may interfere with the system supply when the battery is absent. The soft-start activates whenever V_{OREG} , I_{INLIM} , or $I_{OCHARGE}$ are set from a lower to higher value. During soft-start, the I_{IN} limit drops to 100 mA for about 1 ms unless I_{INLIM} is set to 11 (no limit). This could cause the system processor to fail to start. To avoid this behavior, use the following sequence.

1. Set the OTG pin HIGH. When VBUS is plugged in, I_{INLIM} is set to 500 mA until the system processor powers up and can set parameters through I²C.
2. Program the Safety Register.
3. Set I_{INLIM} to 11 (no limit).
4. Set OREG to the desired value (typically 4.18).
5. Reset the IO_LEVEL bit, then set IOCHARGE.
6. Set I_{INLIM} to 500 mA if a USB source is connected.

During the initial system startup, while the charger IC is being programmed, the system current is limited to 500 mA for 1 ms during steps 4 and 5. This is the value of the soft-start $I_{OCHARGE}$ current used when I_{INLIM} is set to No Limit.

If the system is powered up without a battery present, the CV bit should be set. When a battery is inserted, the CV bit is cleared.

Charger Status / Fault Status

The STAT pin indicates the operating condition of the IC and provides a fault indicator for interrupt driven systems.

Table 17. STAT PIN FUNCTION

EN_STAT	Charge State	STAT Pin
0	X	OPEN
X	Normal Conditions	OPEN
1	Charging	LOW
X	Fault (Charging or Boost)	128 μ s Pulse, then OPEN

The FAULT bits (REG 00[2:0]) indicate the type of fault in Charge Mode. See Table 18 for details.

Table 18. FAULT STATUS BITS DURING CHARGE MODE

Fault Bit			Fault Description
B2	B1	B0	
0	0	0	Normal (No Fault)
0	0	1	VBUS OVP
0	1	0	Sleep Mode
0	1	1	Poor Input Source
1	0	0	Battery OVP
1	0	1	Thermal Shutdown
1	1	0	Timer Fault
1	1	1	No Battery

Charge Mode Control Bits

Setting either HZ_MODE or \overline{CE} through I²C disables the charger and puts the IC into High-Impedance Mode. The t_{32S} timer will continue to run. If it is allowed to expire, all registers (except SAFETY) reset, which enables t_{15MIN} charging. When the t_{15MIN} expires, the IC sets the \overline{CE} bit and the IC enters High-Impedance Mode. If \overline{CE} was set by t_{15MIN} overflow, a new charge cycle can only be initiated through I²C or VBUS POR.

Setting the RESET bit clears all registers (except Safety).

Table 19. DISABLE PIN AND \overline{CE} BIT FUNCTIONALITY

Charging	DISABLE Pin	\overline{CE}	HZ_MODE
ENABLE	0	0	0
DISABLE	X	1	X
DISABLE	X	X	1
DISABLE	1	X	X

Raising the DISABLE pin does stop the t_{32S} from advancing. If the DISABLE pin is raised during t_{15MIN} charging, the t_{15MIN} timer is reset.

Operational Mode Control

OPA_MODE (REG 01[0]) and the HZ_MODE (REG 01[1]) bits in conjunction with the FAULT state define the operational mode of the charger.

Table 20. OPERATION MODE CONTROL

HZ_MODE	OPA_MODE	FAULT	Operation Mode
0	0	0	Charge
0	X	1	Charge Configure
0	1	0	Boost
1	X	X	High Impedance

The IC resets the OPA_MODE bit whenever the boost is deactivated, whether due to a fault or being disabled by setting the HZ_MODE bit.

Boost Mode

Boost Mode can be enabled if the IC is in 32-Second Mode with the OTG pin and OPA_MODE bits as indicated in Table 21. The OTG pin ACTIVE state is 1 if OTG_PL=1 and 0 when OTG_PL=0.

If boost is active using the OTG pin, Boost Mode is initiated even if the HZ_MODE=1. The HZ_MODE bit overrides the OPA_MODE bit.

Table 21. ENABLING BOOST

OTG_EN	OTG Pin	HZ_MODE	OPA_MODE	BOOST
1	ACTIVE	X	X	Enabled
X	X	0	1	Enabled
X	\overline{ACTIVE}	X	0	Disabled
0	X	1	X	Disabled
1	\overline{ACTIVE}	1	1	Disabled
0	ACTIVE	0	0	Disabled

To remain in Boost Mode, the TMR_RST must be set by the host before the t_{32S} timer times out. If t_{32S} times out in Boost Mode; the IC resets all registers, pulses the STAT pin, sets the FAULT bits to 110, and resets the BOOST bit. VBUS POR or reading REG00 clears the fault condition.

Boost PWM Control

The IC uses a minimum on-time and computed minimum off-time to regulate VBUS. The regulator achieves excellent transient response by employing current-mode modulation. This technique causes the regulator to exhibit a load line. During PWM Mode, the output voltage drops slightly as the input current rises. With a constant V_{BAT}, this appears as a constant output resistance.

The “droop” caused by the output resistance when a load is applied allows the regulator to respond smoothly to load transients with no undershoot from the load line. This can be seen in Figure 32 and Figure 40.

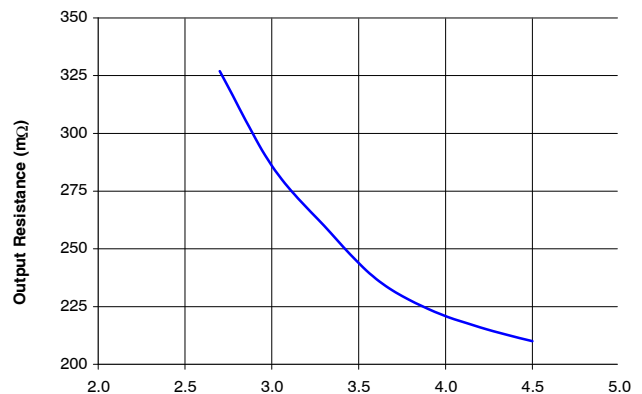

Figure 40. Output Resistance (R_{OUT})

V_{BUS} as a function of I_{LOAD} can be computed when the regulator is in PWM Mode (continuous conduction) as:

$$V_{BUS} = 5.07 - R_{OUT} \cdot I_{LOAD} \quad (\text{eq. 1})$$

At $V_{BAT}=3.3$ V, and $I_{LOAD}=200$ mA, V_{BUS} would drop to:

$$V_{BUS} = 5.07 - 0.26 \cdot 0.2 = 5.018 \text{ V} \quad (\text{eq. 2})$$

At $V_{BAT}=2.7$ V, and $I_{LOAD}=200$ mA, V_{BUS} would drop to:

$$V_{BUS} = 5.07 - 0.327 \cdot 0.2 = 5.005 \text{ V} \quad (\text{eq. 3})$$

PFM Mode

If $V_{BUS} > V_{BOOST}$ (nominally 5.07 V) when the minimum off-time has ended, the regulator enters PFM Mode. Boost pulses are inhibited until $V_{BUS} < V_{BOOST}$. The minimum on-time is increased to enable the output to pump up sufficiently with each PFM boost pulse. Therefore the regulator behaves like a constant on-time regulator, with the bottom of its output voltage ripple at 5.07 V in PFM Mode.

Table 22. BOOST PWM OPERATING STATES

Mode	Description	Invoked When
LIN	Linear Startup	$V_{BAT} > V_{BUS}$
SS	Boost Soft-Start	$V_{BUS} < V_{BOOST}$
BST	Boost Operating Mode	$V_{BAT} > UVLO_{BST}$ and SS Completed

Startup

When the boost regulator is shut down, current flow is prevented from V_{BAT} to V_{BUS} , as well as reverse flow from V_{BUS} to V_{BAT} .

LIN State

When the boost is enabled, if $V_{BAT} > UVLO_{BST}$, the regulator first attempts to bring $PMID$ within 400 mV of V_{BAT} using an internal 450 mA current source from V_{BAT} (LIN State). If $PMID$ has not achieved $V_{BAT} - 400$ mV after 560 μ s, a FAULT state is initiated.

SS State

When $PMID > V_{BAT} - 400$ mV, the boost regulator begins switching with a reduced peak current limit of about 50% of its normal current limit. The output slews up until V_{BUS} is within 5% of its setpoint; at which time, the regulation loop is closed and the current limit is set to 100%.

If the output fails to achieve 95% of its setpoint (V_{BST}) within 128 μ s, the current limit is increased to 100%. If the output fails to achieve 95% of its setpoint after this second 384 μ s period, a fault state is initiated.

BST State

This is the normal operating mode of the regulator. The regulator uses a scheme of calculated t_{OFF} , modulated t_{ON} with a minimum t_{ON} . The calculated t_{OFF} is proportional to V_{IN} / V_{OUT} , which keeps the regulator’s switching frequency reasonably constant in CCM.

To ensure V_{BUS} does not pump significantly above the regulation point, the boost switch remains off as long as the actual output voltage is greater than the regulation point.

Boost Faults

If a BOOST fault occurs:

1. The STAT pin pulses.
2. OPA_MODE bit is reset.
3. The power stage is in High-Impedance Mode.
4. The FAULT bits (REG 00[2:0]) are set per Table 23

Restart After Boost Faults

If boost was enabled with the OPA_MODE bit and $OTG_EN=0$, Boost Mode can only be enabled through subsequent I²C commands since OPA_MODE is reset on boost faults. If $OTG_EN=1$ and the OTG pin is still ACTIVE (see Table 21), the boost restarts after a 5.2 ms delay, as shown in Figure 41. If the fault condition persists, restart is attempted every 5 ms until the fault clears or an I²C command disables the boost.

Table 23. FAULT BITS DURING BOOST MODE

Fault Bit			Fault Description
B2	B1	B0	
0	0	0	Normal (no fault)
0	0	1	$V_{BUS} > V_{BUS_{OVP}}$
0	1	0	V_{BUS} fails to achieve the voltage required to advance to the next state during soft-start or sustained (>50 μ s) current limit during the BST state.
0	1	1	$V_{BAT} < UVLO_{BST}$
1	0	0	N/A: This code does not appear.
1	0	1	Thermal shutdown
1	1	0	Timer fault; all registers reset.
1	1	1	N/A: This code does not appear.

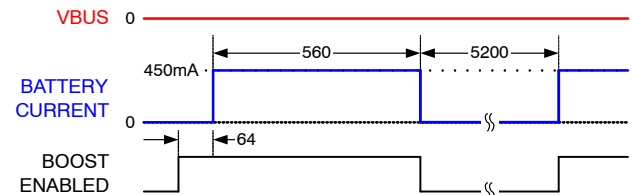

Figure 41. Boost Response Attempting to Start into V_{BUS} Short Circuit (times in μ s)

VREG Pin

The 1.8 V regulated output on this pin can be disabled through I²C by setting the DIS_VREG bit (REG 05[6]). VREG can supply up to 2 mA. This circuit, which is powered from $PMID$, is enabled only when $PMID > V_{BAT}$ and does not drain current from the battery. During boost, V_{REG} is off. It is also off when the HZ_MODE bit (REG 01[1])=1.

Monitor Register (Reg 10h)

Additional status monitoring bits enable the host processor to have more visibility into the status of the IC. The monitor bits are real-time status indicators and are not internally debounced or otherwise time qualified.

The state of the MONITOR register bits listed in High-Impedance Mode is only valid when V_{BUS} is valid.

I²C Interface

The FAN54005's serial interface is compatible with Standard, Fast, Fast Plus, and High-Speed Mode I²C-Bus specifications. The SCL line is an input and the SDA line is a bi-directional open-drain output; it can only pull down the bus when active. The SDA line only pulls LOW during data reads and signaling ACK. All data is shifted in MSB (bit 7) first.

Slave Address

Table 24. I²C SLAVE ADDRESS BYTE

Part Type	7	6	5	4	3	2	1	0
FAN54005	1	1	0	1	0	1	0	R/W

In hex notation, the slave address assumes a 0 LSB. The hex slave address for the FAN54005 is D4H and is D6H for all other parts in the family.

Bus Timing

As shown in Figure 42, data is normally transferred when SCL is LOW. Data is clocked in on the rising edge of SCL. Typically, data transitions shortly at or after the falling edge of SCL to allow ample time for the data to set up before the next SCL rising edge.

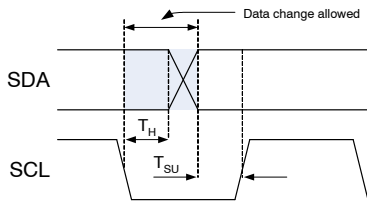

Figure 42. Data Transfer Timing

Each bus transaction begins and ends with SDA and SCL HIGH. A transaction begins with a START condition, which is defined as SDA transitioning from 1 to 0 with SCL HIGH, as shown in Figure 43.

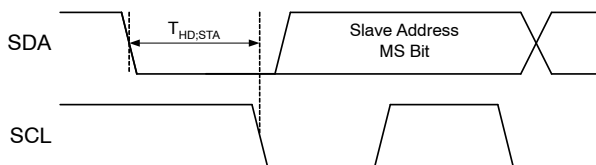

Figure 43. Start Bit

A transaction ends with a STOP condition, which is defined as SDA transitioning from 0 to 1 with SCL HIGH, as shown in Figure 44.

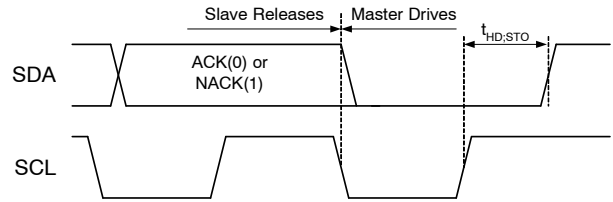

Figure 44. Stop Bit

During a read from the FAN54005 (Figure 47), the master issues a Repeated Start after sending the register address and before resending the slave address. The Repeated Start is a 1-to-0 transition on SDA while SCL is HIGH, as shown in Figure 45.

High-Speed (HS) Mode

The protocols for High-Speed (HS), Low-Speed (LS), and Fast-Speed (FS) Modes are identical except the bus speed for HS Mode is 3.4 MHz. HS Mode is entered when the bus master sends the HS master code 00001XXX after a start condition. The master code is sent in Fast or Fast Plus Mode (less than 1 MHz clock); slaves do not ACK this transmission.

The master then generates a repeated start condition (Figure 45) that causes all slaves on the bus to switch to HS Mode. The master then sends I²C packets, as described above, using the HS Mode clock rate and timing.

The bus remains in HS Mode until a stop bit (Figure 44) is sent by the master. While in HS Mode, packets are separated by repeated start conditions (Figure 45).

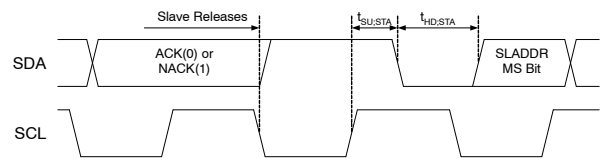

Figure 45. Repeated Start Timing

Read and Write Transactions

The figures below outline the sequences for data read and write. Bus control is signified by the shading of the packet, defined as

Master Drives Bus

and

Slave Drives Bus

All addresses and data are MSB first.

FAN54005

Table 25. BIT DEFINITIONS FOR FIGURE 46 AND FIGURE 47

Symbol	Definition
S	START, see Figure 43
A	ACK. The slave drives SDA to 0 to acknowledge the preceding packet.
\bar{A}	NACK. The slave sends a 1 to NACK the preceding packet.
R	Repeated START, see Figure 45
P	STOP, see Figure 44

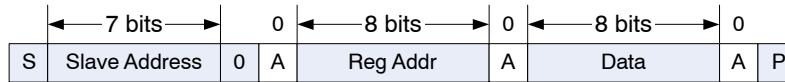

Figure 46. Write Transaction

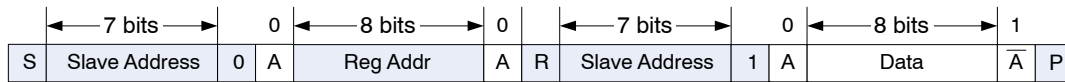

Figure 47. Read Transaction

Register Descriptions

The nine FAN54005 user-accessible registers are defined in Table 26.

Table 26. I²C REGISTER ADDRESS

Register		Address Bits							
Name	REG#	7	6	5	4	3	2	1	0
CONTROL0	00	0	0	0	0	0	0	0	0
CONTROL1	01	0	0	0	0	0	0	0	1
OREG	02	0	0	0	0	0	0	1	0
IC_INFO	03	0	0	0	0	0	0	1	1
IBAT	04	0	0	0	0	0	1	0	0
SP_CHARGER	05	0	0	0	0	0	1	0	1
SAFETY	06	0	0	0	0	0	1	1	0
MONITOR	10h	0	0	0	1	0	0	0	0

FAN54005

Table 27. REGISTER BIT DEFINITIONS

This table defines the operation of each register bit for all IC versions. Default values are in **bold** text.

Bit	Name	Value	Type	Description
CONTROL0				Register Address: 00 Default Value=X1XX 0XXX
7	TMR_RST OTG	1	W	Writing a 1 resets the t_{32S} timer; writing a 0 has no effect
			R	Returns the OTG pin level (1=HIGH)
6	EN_STAT	0	R/W	Prevents STAT pin from going LOW during charging; STAT pin still pulses to enunciate faults
		1		Enables STAT pin LOW when IC is charging
5:4	STAT	00	R	Ready
		01		Charge in progress
		10		Charge done
		11		Fault
3	BOOST	0	R	IC is not in Boost Mode
		1		IC is in Boost Mode
2:0	FAULT		R	Fault status bits: for Charge Mode, see Table 18
CONTROL1				Register Address: 01 Default Value=0111 0000 (70h)
7:6	IINLIM	01	R/W	Input current limit, see Table 12
5:4	VLOWV	00	R/W	3.4 V
		01		3.5 V
		10		3.6 V
		11		3.7 V
3	TE	0	R/W	Disable charge current termination
		1		Enable charge current termination
2	\overline{CE}	0	R/W	Charger enabled.
		1		Charger disabled. The T_{32S} timer is not suspended
1	HZ_MODE	0	R/W	Not High-Impedance Mode
		1		High-Impedance Mode
0	OPA_MODE	0	R/W	Charge Mode
		1		Boost Mode
OREG				Register Address: 02 Default Value=0000 1010 (0Ah)
7:2	OREG	000010	R/W	Charger output "float" voltage; programmable from 3.5 to 4.44 V in 20 mV increments; defaults to 000010 (3.54 V) . See Table 8
1	OTG_PL	0	R/W	OTG pin active LOW
		1		OTG pin active HIGH
0	OTG_EN	0	R/W	Disables OTG pin
		1		Enables OTG pin
IC_INFO				Register Address: 03 Default Value=100101XX (9Xh)
7:5	Vendor Code	100	R	Identifies ON Semiconductor as the IC supplier
4:2	PN	101	R	Part number bits, see the Ordering Information on page 1
1:0	REV	XX	R	IC Revision bits
IBAT				Register Address: 04 Default Value=1000 1001 (89h)
7	RESET	1	W	Writing a 1 resets charge parameters, except the Safety register (REG 06), to their defaults; writing a 0 has no effect; read returns 1
6:4	IOCHARGE	000	R/W	Programs the maximum charge current when IO_LEVEL (REG 05[5]) = 0. See Table 10

FAN54005

Table 27. REGISTER BIT DEFINITIONS

This table defines the operation of each register bit for all IC versions. Default values are in **bold** text.

Bit	Name	Value	Type	Description
3	Reserved	1	R	Unused
2:0	ITERM	001	R/W	Sets the current used for charging termination. See Table 11
SP_CHARGER			Register Address: 05 Default Value=001X X100	
7	Reserved	0	R	Unused
6	DIS_VREG	0	R/W	1.8 V regulator is ON
		1		1.8 V regulator is OFF
5	IO_LEVEL	0	R/W	Output current is controlled by the IOCHARGE bits
		1		Output current control is limited to 34 mV across R _{SNS}
4	SP	0	R	DIVC is not active (V _{BUS} is able to stay above V _{SP})
		1		DIVC has been detected and V _{BUS} is being regulated to V _{SP}
3	EN_LEVEL	0	R	DISABLE pin is LOW
		1		DISABLE pin is HIGH
2:0	VSP	100	R/W	DIVC input regulation voltage. See Table 13
SAFETY			Register Address: 06 Default Value=0100 0000 (40h)	
7	Reserved	0	R	Bit disabled and always returns 0 when read back
6:4	ISAFE	100	R/W	Sets the maximum I _{OCHARGE} value used by the control circuit. See Table 14
3:0	VSAFE	0000	R/W	Sets the maximum V _{OREG} used by the control circuit. See Table 15
MONITOR			Register Address: 10h (16)	
7	ITERM_CMP		R	ITERM comparator output, 1 when VRSENSE > See Table 11
6	VBAT_CMP		R	Output of VBAT comparator 1 during charging indicates V _{BAT} > V _{SHORT} 1 during HZ_MODE indicates V _{BAT} > V _{LOWV} 1 during Boost Mode indicated V _{BAT} > UVLO _{BST}
5	LINCHG		R	30 mA linear charger ON
4	T_120		R	Thermal regulation comparator; when=1 and T_145=0, the charge current is limited to 22.1 mV across R _{SENSE}
3	ICHG		R	0 indicates the I _{OCHARGE} loop is controlling the battery charge current
2	IBUS		R	0 indicates the IBUS (input current) loop is controlling the battery charge current
1	VBUS_VALID		R	1 indicates VBUS has passed validation and is capable of charging
0	CV		R	1 indicates the constant-voltage loop (OREG) had been active at least once since the last V _{BUS} plug in 0 indicates the constant-voltage loop (OREG) had never been reached since the last V _{BUS} plug in or the part is in the Charge Done state with TE=1

FAN54005

PCB Layout Recommendations

Bypass capacitors should be placed as close to the IC as possible. In particular, the total loop length for CMID should be minimized to reduce overshoot and ringing on the SW, PMID, and VBUS pins. All power and ground pins must be

routed to their bypass capacitors, using top copper whenever possible. Copper area connecting to the IC should be maximized to improve thermal performance if possible.

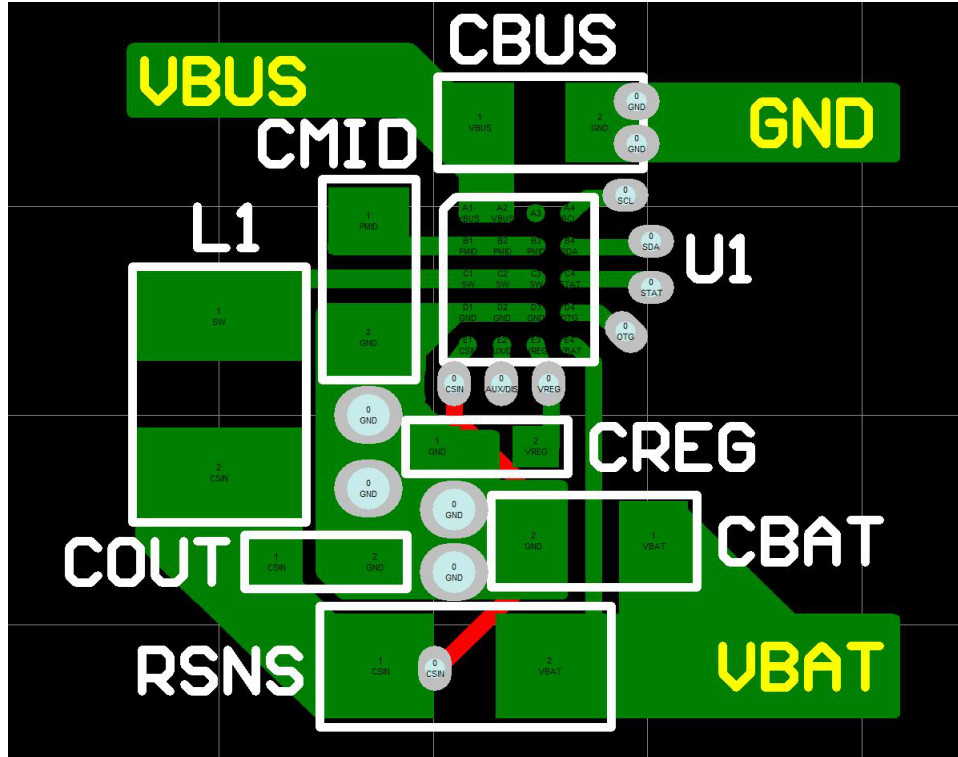

Figure 48. PCB Layout Recommendations

The table below pertains to the MOD information on the following page.

PRODUCT-SPECIFIC DIMENSIONS

Product	D	E	X	Y
FAN54005UCX	1.960 ±0.030 mm	1.870 ±0.030 mm	0.335 mm	0.180 mm

WLCSP20 1.96x1.87x0.586
CASE 567SL
ISSUE O

DATE 30 NOV 2016

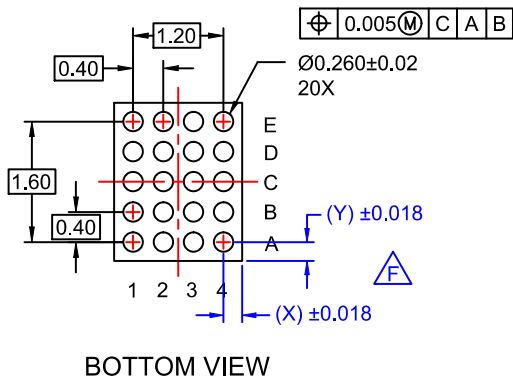
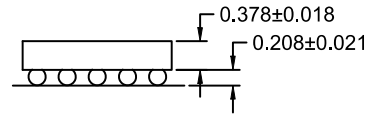
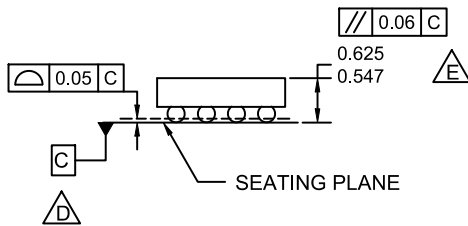
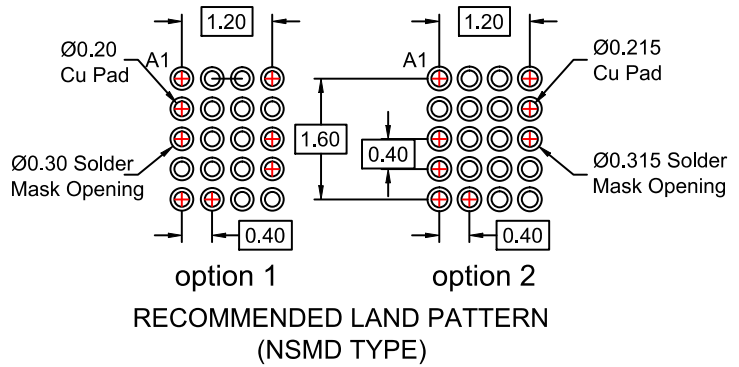
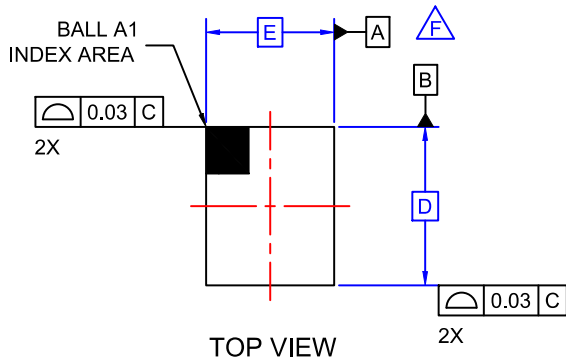

NOTES:

- A. NO JEDEC REGISTRATION APPLIES.
- B. DIMENSIONS ARE IN MILLIMETERS.
- C. DIMENSIONS AND TOLERANCE PER ASMEY14.5M, 2009.
- D. DATUM C IS DEFINED BY THE SPHERICAL CROWNS OF THE BALLS.
- E. PACKAGE NOMINAL HEIGHT IS 586 MICRONS ±39 MICRONS (547-625 MICRONS).
- F. FOR DIMENSIONS D, E, X, AND Y SEE PRODUCT DATASHEET.

DOCUMENT NUMBER:	98AON16608G	Electronic versions are uncontrolled except when accessed directly from the Document Repository. Printed versions are uncontrolled except when stamped "CONTROLLED COPY" in red.
DESCRIPTION:	WLCSP20 1.96x1.87x0.586	PAGE 1 OF 1

ON Semiconductor and are trademarks of Semiconductor Components Industries, LLC dba ON Semiconductor or its subsidiaries in the United States and/or other countries. ON Semiconductor reserves the right to make changes without further notice to any products herein. ON Semiconductor makes no warranty, representation or guarantee regarding the suitability of its products for any particular purpose, nor does ON Semiconductor assume any liability arising out of the application or use of any product or circuit, and specifically disclaims any and all liability, including without limitation special, consequential or incidental damages. ON Semiconductor does not convey any license under its patent rights nor the rights of others.

onsemi, **Onsemi**, and other names, marks, and brands are registered and/or common law trademarks of Semiconductor Components Industries, LLC dba "**onsemi**" or its affiliates and/or subsidiaries in the United States and/or other countries. **onsemi** owns the rights to a number of patents, trademarks, copyrights, trade secrets, and other intellectual property. A listing of **onsemi**'s product/patent coverage may be accessed at www.onsemi.com/site/pdf/Patent-Marking.pdf. **onsemi** reserves the right to make changes at any time to any products or information herein, without notice. The information herein is provided "as-is" and **onsemi** makes no warranty, representation or guarantee regarding the accuracy of the information, product features, availability, functionality, or suitability of its products for any particular purpose, nor does **onsemi** assume any liability arising out of the application or use of any product or circuit, and specifically disclaims any and all liability, including without limitation special, consequential or incidental damages. Buyer is responsible for its products and applications using **onsemi** products, including compliance with all laws, regulations and safety requirements or standards, regardless of any support or applications information provided by **onsemi**. "Typical" parameters which may be provided in **onsemi** data sheets and/or specifications can and do vary in different applications and actual performance may vary over time. All operating parameters, including "Typicals" must be validated for each customer application by customer's technical experts. **onsemi** does not convey any license under any of its intellectual property rights nor the rights of others. **onsemi** products are not designed, intended, or authorized for use as a critical component in life support systems or any FDA Class 3 medical devices or medical devices with a same or similar classification in a foreign jurisdiction or any devices intended for implantation in the human body. Should Buyer purchase or use **onsemi** products for any such unintended or unauthorized application, Buyer shall indemnify and hold **onsemi** and its officers, employees, subsidiaries, affiliates, and distributors harmless against all claims, costs, damages, and expenses, and reasonable attorney fees arising out of, directly or indirectly, any claim of personal injury or death associated with such unintended or unauthorized use, even if such claim alleges that **onsemi** was negligent regarding the design or manufacture of the part. **onsemi** is an Equal Opportunity/Affirmative Action Employer. This literature is subject to all applicable copyright laws and is not for resale in any manner.

PUBLICATION ORDERING INFORMATION

LITERATURE FULFILLMENT:

Email Requests to: orderlit@onsemi.com

onsemi Website: www.onsemi.com

TECHNICAL SUPPORT

North American Technical Support:

Voice Mail: 1 800-282-9855 Toll Free USA/Canada

Phone: 011 421 33 790 2910

Europe, Middle East and Africa Technical Support:

Phone: 00421 33 790 2910

For additional information, please contact your local Sales Representative