



## DESCRIPTION

The MPQ24833-B is a 55V, 3A, LED driver suitable for step-down, inverting step-up/step-down, and step-up applications. The MPQ24833-B achieves 3A of output current with excellent load and line regulation over a wide input supply range.

Current mode operation provides a fast transient response and eases loop stabilization. Full protection features include thermal shutdown, cycle-by-cycle peak current limiting, open-string protection, and output short-circuit protection (SCP).

The MPQ24833-B incorporates both DC and PWM dimming into a single control pin. The separate input reference ground pin allows for direct enable and/or dimming control for a positive-to-negative power conversion.

The MPQ24833-B requires a minimal number of readily available, standard external components, and is available in an SOIC-8 EP package.

## FEATURES

- 3A Maximum Output Current
- Unique Step-Up/Step-Down Operation (Buck-Boost Mode)
- Wide 4.5V to 55V Operating Input Range for Step-Down Applications (Buck Mode)
- 0.15Ω Internal Power MOSFET Switch
- Fixed 420kHz Switching Frequency
- Analog and PWM Dimming
- 0.2V Reference Voltage
- 6μA Shutdown Mode
- No Minimum Number of LEDs Required
- Stable with Low-ESR Output Ceramic Capacitors
- Cycle-by-Cycle Over-Current Protection (OCP)
- Thermal Shutdown Protection
- Open-String Protection
- Output Short-Circuit Protection (SCP)
- Available in an SOIC-8 EP Package
- Available in AEC-Q100 Grade 1

## APPLICATIONS

- General LED Illumination
- LCD Backlight Panels
- Automotive Lighting
- Portable Multimedia Players
- Portable GPS Devices

---

All MPS parts are lead-free, halogen-free, and adhere to the RoHS directive. For MPS green status, visit the MPS website under Quality Assurance. "MPS", the MPS logo, and "Simple, Easy Solutions" are registered trademarks of Monolithic Power Systems, Inc. or its subsidiaries.

## TYPICAL APPLICATION

### Buck Mode

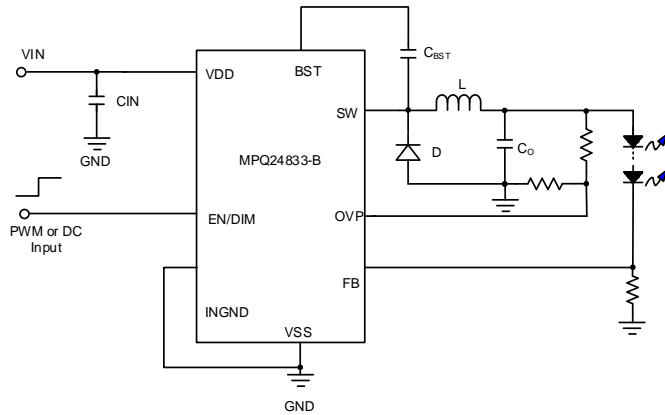

### Efficiency vs. $V_{IN}$

$V_{LED} = 6.2V$

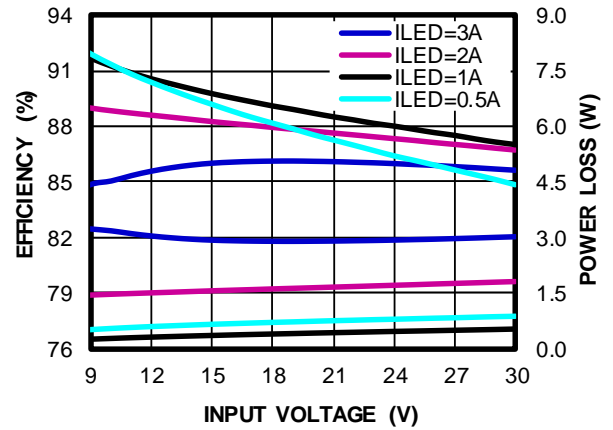

### Buck-Boost Mode

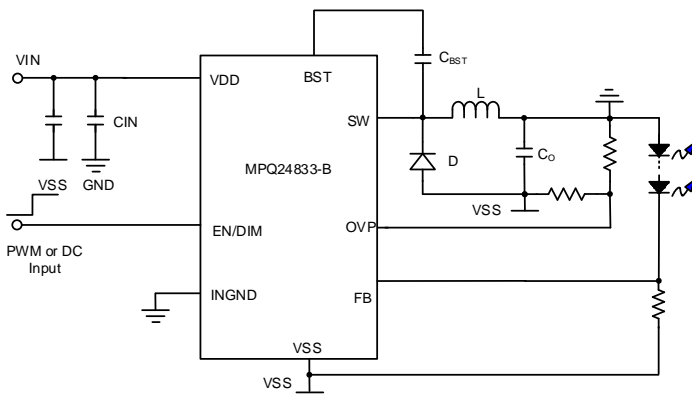

### Efficiency vs. $V_{IN}$

$V_{LED} = 21V$

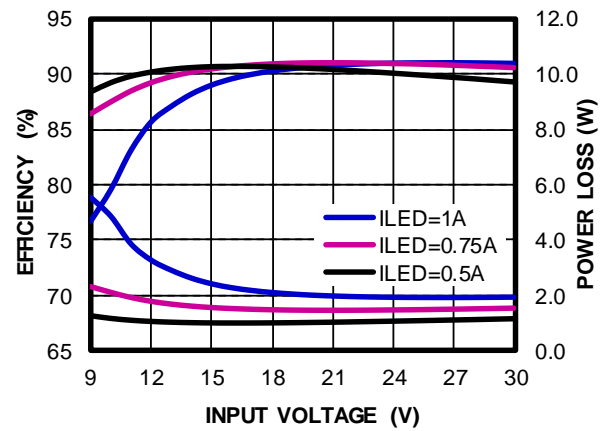

### ORDERING INFORMATION

Part Number*	Package	Top Marking	MSL Rating**
MPQ24833-BGN-AEC1	SOIC-8 EP	See Below	Level 1

\* For Tape & Reel, add suffix -Z (e.g. MPQ24833-BGN-AEC1-Z).

\*\* Moisture Sensitivity Level Rating

### TOP MARKING

**M24833-B**

**LLLLLLLL**

**MPSYWW**

M24833-B: Part number  
 LLLLLLLL: Lot number  
 MPS: MPS prefix  
 Y: Year code  
 WW: Week code

### PACKAGE REFERENCE

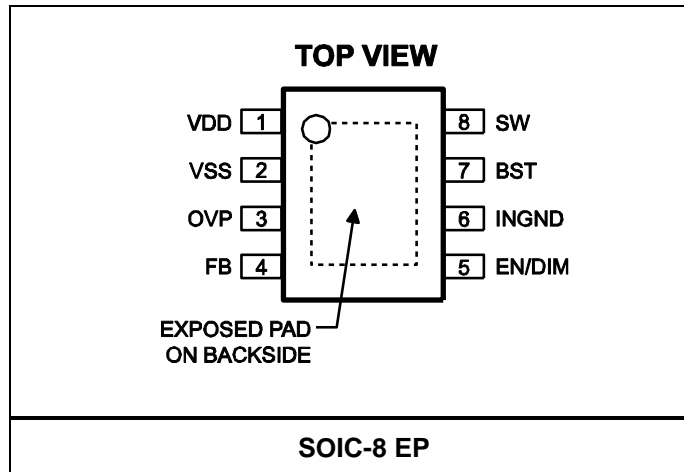

## PIN FUNCTIONS

Pin #	Name	Description
1	VDD	<b>Supply voltage.</b> The MPQ24833-B operates from a 4.5V to 55V unregulated input (with respect to VSS). An input capacitor is needed to prevent large voltage spikes from appearing at input.
2	VSS, exposed pad	<b>Power return.</b> VSS is the voltage reference for the regulated output voltage, and requires extra care during layout. Connect VSS to the lowest potential in the circuit, which is typically the anode of the Schottky rectifier. The exposed pad is also connected to VSS.
3	OVP	<b>Over-voltage protection.</b> Use a voltage divider to program the OVP threshold. When the OVP voltage reaches the shutdown threshold (2.43V), the switch turns off and recovers when the OVP voltage drops to its normal operating range. When the voltage (with respect to VSS) drops below 0.2V, and the FB voltage is below 0.1V, the chip treats this as a short circuit and the operating frequency folds back. Program the OVP voltage from 0.2V to 2.43V for normal operation.
4	FB	<b>LED current feedback input.</b> FB senses the current across the sensing resistor between FB and VSS. Connect the current-sensing resistor from the bottom of the LED strings to VSS. FB is connected to the bottom of the LED strings. The regulation voltage is 0.2V.
5	EN/DIM	<b>On/off control input and dimming command input.</b> A voltage above 0.8V turns on the chip. EN/DIM implements both DC and PWM dimming. When the EN/DIM voltage (with respect to INGND) rises from 0.75V to 1.5V, the LED current changes from 0% to 100% of the maximum LED current. To use PWM dimming, apply a 100Hz to 2kHz square wave signal with an amplitude above 1.7V to EN/DIM. For combined analog and PWM dimming, apply a 100Hz to 2kHz square wave signal with an amplitude between 0.75V and 1.5V.
6	INGND	<b>Input ground reference.</b> INGND is the reference for the EN/DIM signal.
7	BST	<b>Bootstrap.</b> Connect a capacitor between SW and BST to form a floating supply for the power switch driver. Use a 100nF or greater ceramic capacitor to provide sufficient energy to drive the power switch with this supply voltage.
8	SW	<b>Switch output.</b> SW is the source of the internal MOSFET. Connect SW to the power inductor and the cathode of the rectifier diode.

**ABSOLUTE MAXIMUM RATINGS** <sup>(1)</sup>

Supply voltage ( $V_{DD} - V_{SS}$ ).....	57V
$V_{SW} - V_{SS}$ .....	-0.3V to $V_{IN} + 0.3V$
$V_{BST}$ .....	$V_{SW} + 6V$
$V_{EN/DIM} - V_{INGND}$ .....	-0.3V to +6V
$V_{INGND} - V_{SS}$ .....	-0.3V to +57V
Other pins - $V_{SS}$ .....	-0.3V to +6V
Continuous power dissipation ( $T_A = 25^\circ C$ ) <sup>(2)</sup>	
SOIC-8 EP .....	2.5W
Junction temperature .....	150°C
Lead temperature .....	260°C
Storage temperature.....	-65°C to +150°C

**Electrostatic Discharge (ESD) Level**

HBM (human body model) .....	$\pm 1.8kV$
CDM (charged device model) .....	$\pm 750V$

**Recommended Operating Conditions**

Supply voltage ( $V_{DD} - V_{SS}$ ).....	4.5V to 55V
Operating junction temp ( $T_J$ ) <sup>(3)</sup>	
.....	-40°C to +125°C

<b>Thermal Resistance</b>	$\theta_{JA}$	$\theta_{JC}$
SOIC-8 EP		
JESD51-7 <sup>(4)</sup> .....	50 .....	10 ... °C/W
EVQ24833-B-00A <sup>(5)</sup> .....	42 .....	6 ... °C/W

**Notes:**

- 1) Exceeding these ratings may damage the device.
- 2) The maximum allowable power dissipation is a function of the maximum junction temperature  $T_J$  (MAX), the junction-to-ambient thermal resistance  $\theta_{JA}$ , and the ambient temperature  $T_A$ . The maximum allowable continuous power dissipation at any ambient temperature is calculated by  $P_D$  (MAX) =  $(T_J$  (MAX) -  $T_A$ ) /  $\theta_{JA}$ . Exceeding the maximum allowable power dissipation produces an excessive die temperature, causing the regulator to go into thermal shutdown. Internal thermal shutdown circuitry protects the device from permanent damage.
- 3) Mission profiles requiring operation above 125°C  $T_J$  may be supported; contact MPS for details.
- 4) Measured on JESD51-7, 6.35cmx6.35cm, 4-layer PCB.
- 5) Measured on MPS standard EVB of MPQ24833, 2-layer, 1oz. PCB.

## ELECTRICAL CHARACTERISTICS

$V_{IN} = 12V$ ,  $V_{EN} = 2V$ ,  $T_J = -40^{\circ}C$  to  $+125^{\circ}C$ , typical values at  $T_J = 25^{\circ}C$ , all voltages with respect to  $V_{SS}$ , unless otherwise noted.

Parameters	Symbol	Condition	Min	Typ	Max	Units
Feedback voltage	$V_{FB}$	$4.5V \leq V_{IN} \leq 55V$ <sup>(6)</sup>	0.19	0.2	0.21	V
Feedback current	$I_{FB}$	$V_{FB} = 0.22V$	-100		+100	nA
Switch on resistance	$R_{DS(ON)}$			150	280	m $\Omega$
Switch leakage		$V_{EN} = 0V$ , $V_{SW} = 0V$			1	$\mu A$
Current limit <sup>(7)</sup>			4.2	6		A
Oscillator frequency	$f_{SW}$		294	420	546	kHz
Foldback frequency		$V_{FB} = 0V$ , $V_{OVP} = 0V$		120		kHz
Maximum duty cycle			85	91	97	%
Minimum on time <sup>(7)</sup>	$t_{ON}$			100		ns
Under-voltage lockout rising threshold			2.9	3.3	3.7	V
Under-voltage lockout threshold hysteresis				200		mV
EN input current		$V_{EN} = 2V$			2.1	$\mu A$
EN off threshold (with respect to INGND)		$V_{EN}$ falling	0.4			V
EN on threshold (with respect to INGND)		$V_{EN}$ rising			0.7	V
Minimum EN dimming threshold		$V_{FB} = 0V$	0.6	0.75	0.9	V
Maximum EN dimming threshold		$V_{FB} = 0.2V$	1.3	1.5	1.7	V
Supply current (quiescent)	$I_Q$	$V_{EN} = 2V$ , $V_{FB} = 1V$		0.6	1	mA
Supply current (quiescent) at EN off	$I_{off}$	$V_{EN} = 0V$		6	12	$\mu A$
Thermal shutdown <sup>(7)</sup>				175		$^{\circ}C$
Thermal shutdown recovery hysteresis <sup>(7)</sup>				30		$^{\circ}C$
Open LED OV threshold	$V_{OVP\_th}$		2.3	2.43	2.6	V
Open LED OV hysteresis	$V_{OVP\_hys}$			80		mV

### Notes:

- 6)  $V_{IN} > 40V$  is guaranteed by design and characterization.  
 7) Not tested in production. Guaranteed by design and characterization.

## TYPICAL CHARACTERISTICS

Shutdown Current vs. Temperature

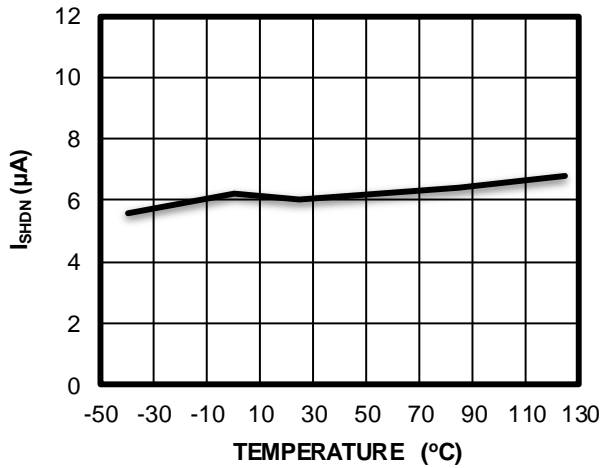

Quiescent Current vs. Temperature

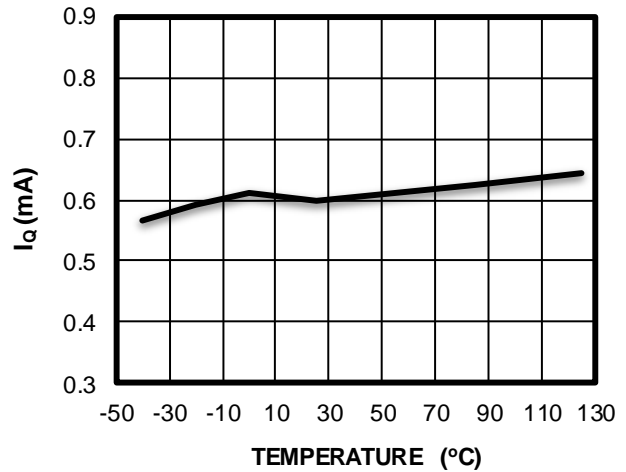

$V_{IN}$  UVLO Threshold vs. Temperature

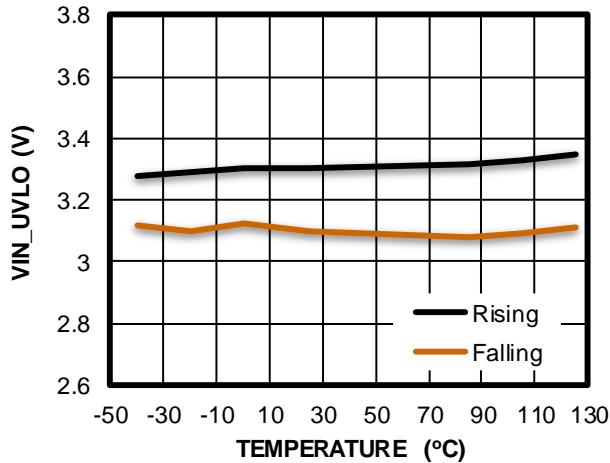

Switching Frequency vs. Temperature

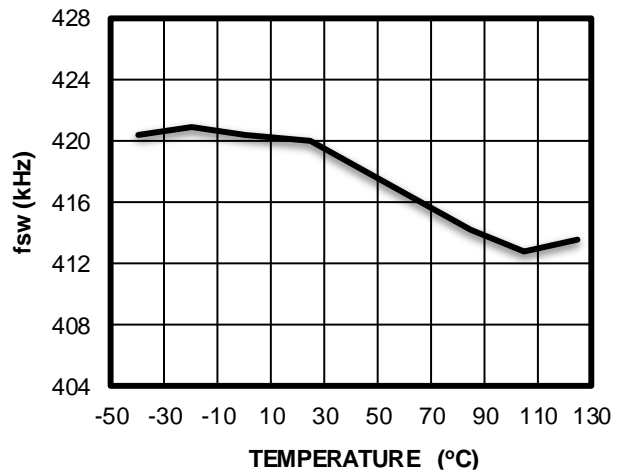

HS-FET On Resistance vs. Temperature

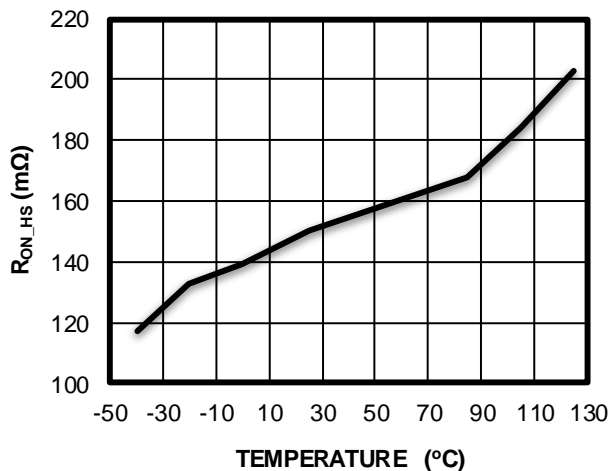

Current Limit vs. Temperature

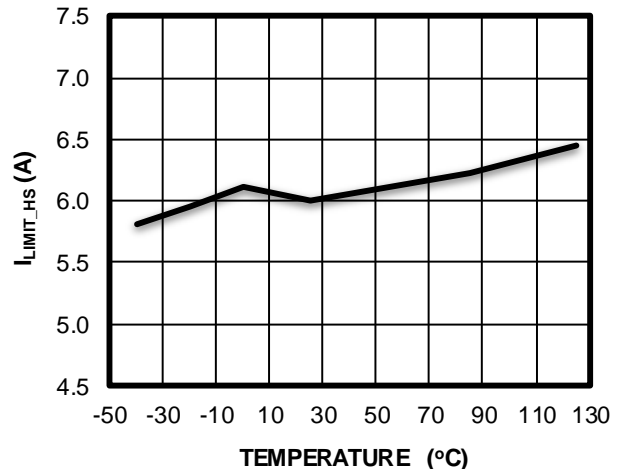

### TYPICAL CHARACTERISTICS

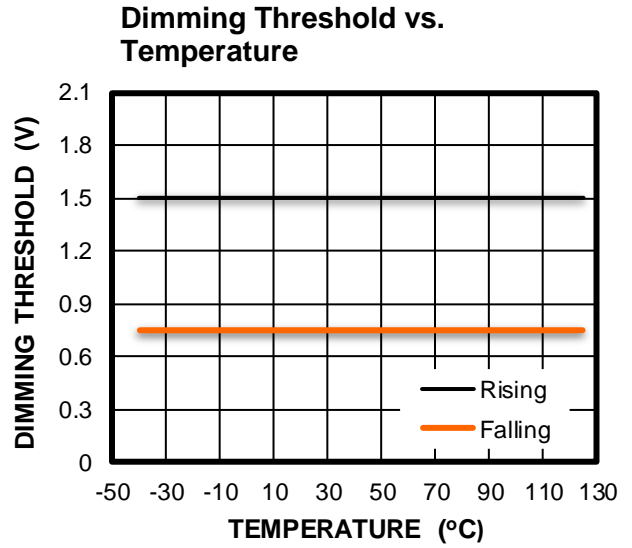
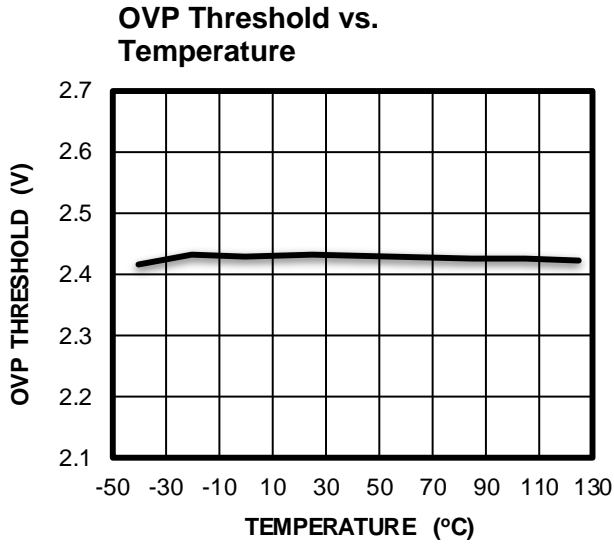



## TYPICAL PERFORMANCE CHARACTERISTICS

$V_{IN} = 12V$ ,  $I_{LED} = 3A$ ,  $V_{LED} = 6.2V$ ,  $L = 33\mu H$ ,  $T_A = 25^\circ C$ , buck application, unless otherwise noted.

$I_{LED}$  vs.  $V_{EN/DIM}$

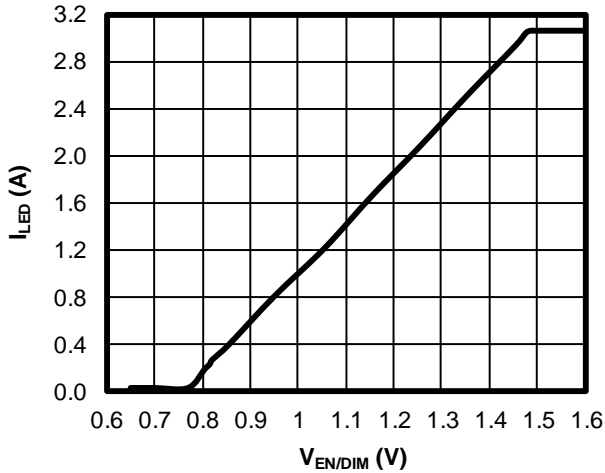

Current Limit vs. Duty

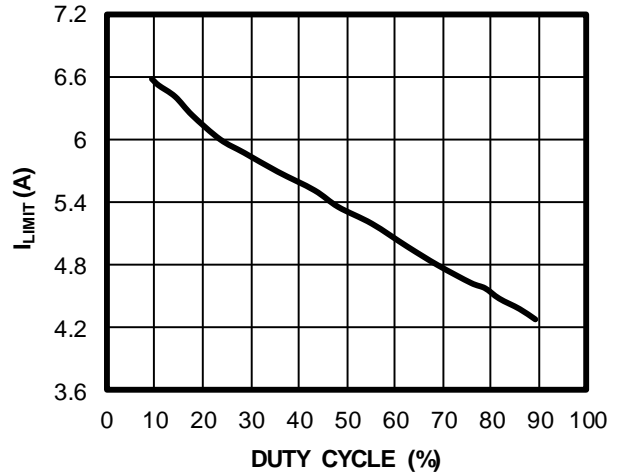

Efficiency vs. Input Voltage

$V_{LED} = 6.2V$

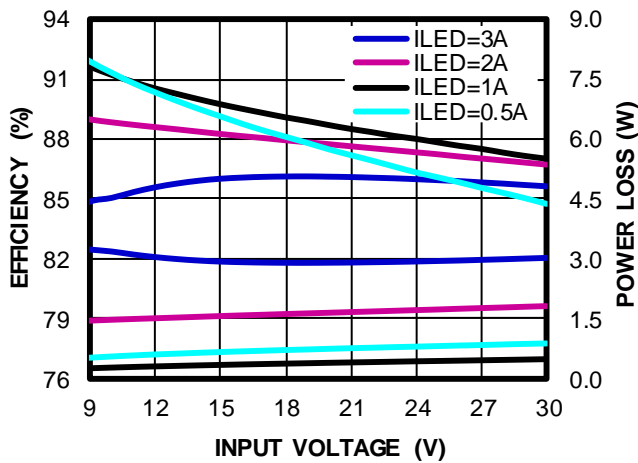

Efficiency vs. Input Voltage

$V_{LED} = 3.1V$

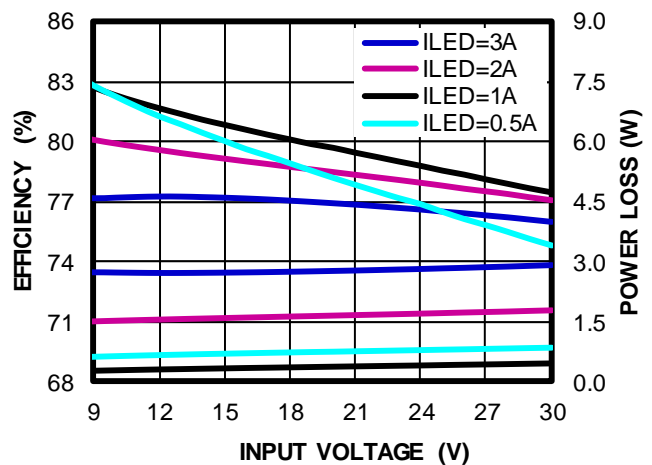

**TYPICAL PERFORMANCE CHARACTERISTICS (continued)**
 $V_{IN} = 12V$ ,  $I_{LED} = 3A$ ,  $V_{LED} = 6.2V$ ,  $L = 33\mu H$ ,  $T_A = 25^\circ C$ , buck application, unless otherwise noted.

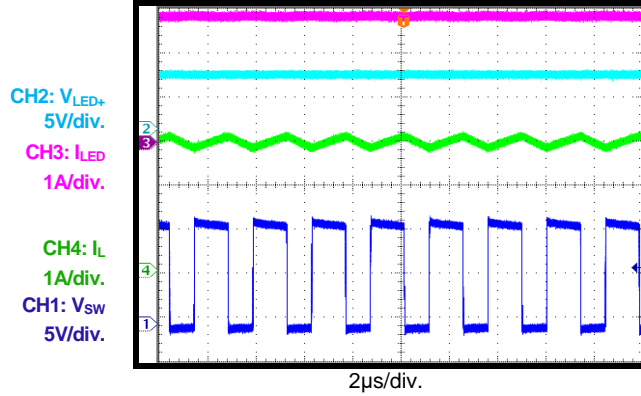
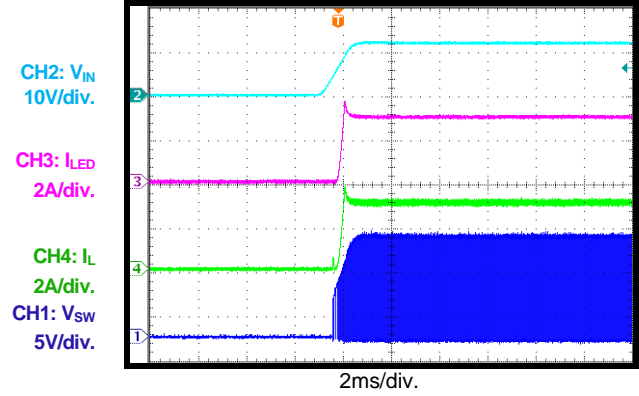
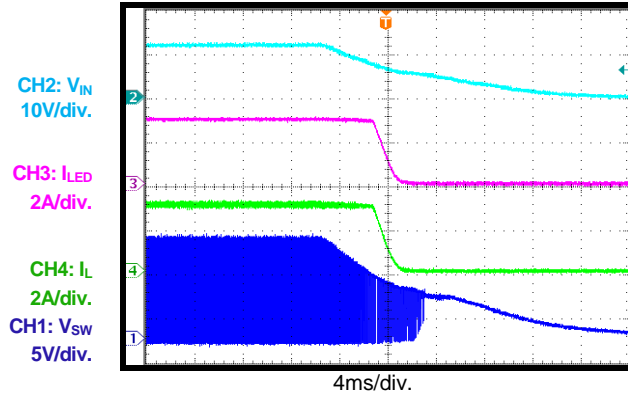
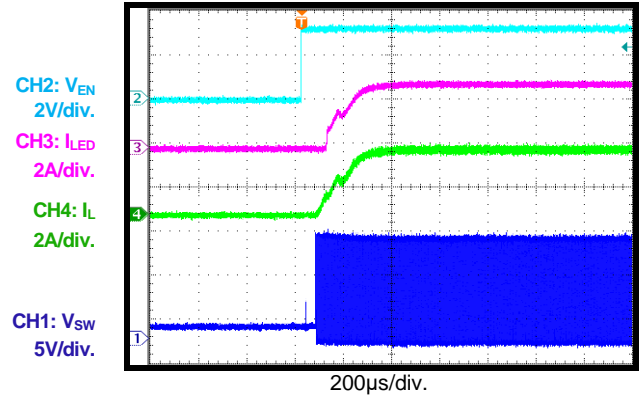
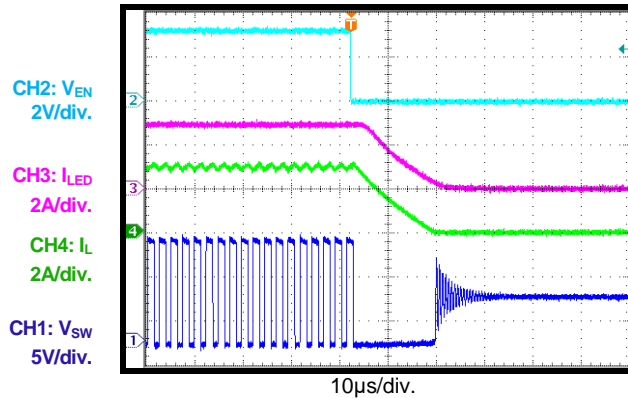
**Steady State**
 $I_{LED} = 3A$ 

**Start-Up through  $V_{IN}$** 
 $I_{LED} = 3A$ 

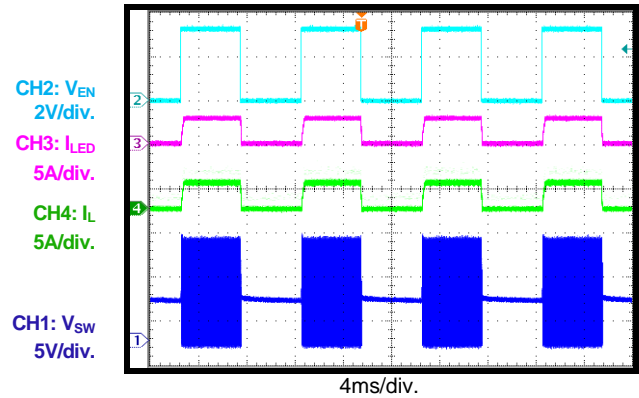
**Shutdown through  $V_{IN}$** 
 $I_{LED} = 3A$ 

**Start-Up through EN**
 $I_{LED} = 3A$ 

**Shutdown through EN**
 $I_{LED} = 3A$ 

**PWM Dimming Steady State**

Dimming frequency = 100Hz



**TYPICAL PERFORMANCE CHARACTERISTICS (continued)**
 $V_{IN} = 12V$ ,  $I_{LED} = 3A$ ,  $V_{LED} = 6.2V$ ,  $L = 33\mu H$ ,  $T_A = 25^\circ C$ , buck application, unless otherwise noted.

**PWM Dimming Steady State**

Dimming frequency = 500Hz

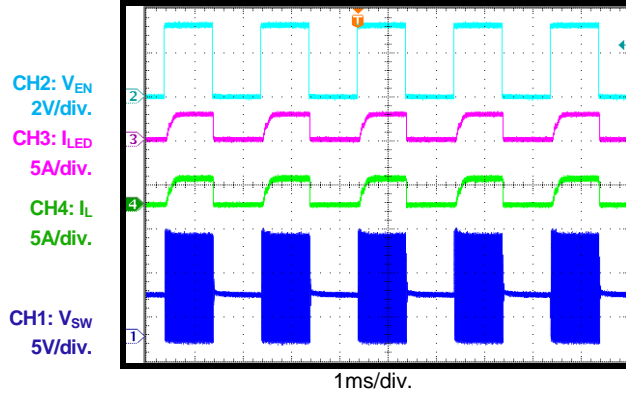
**PWM Dimming @  $f_{DIM} = 100Hz$** 

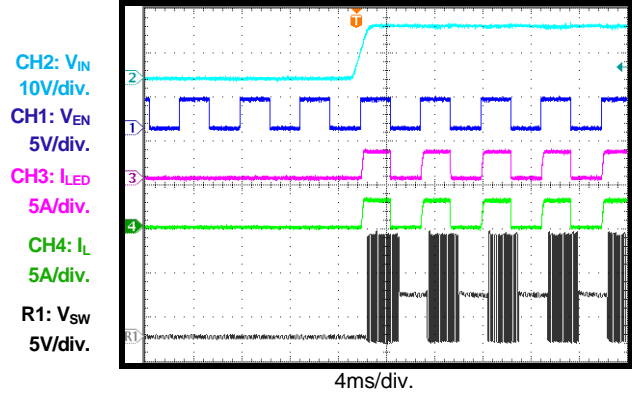
 Start-up through  $V_{IN}$ 

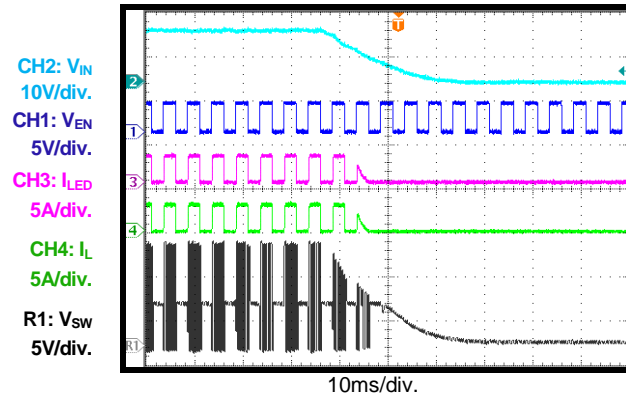
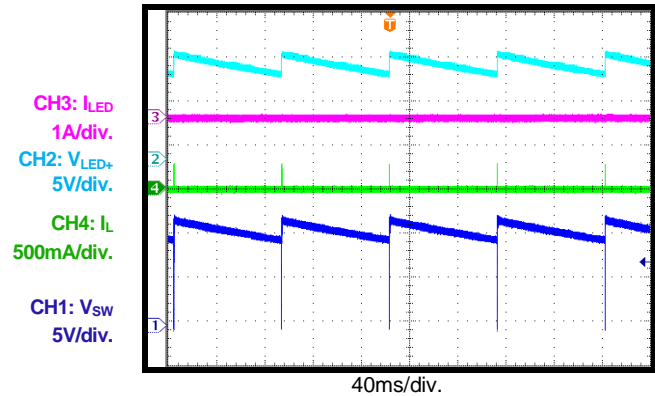
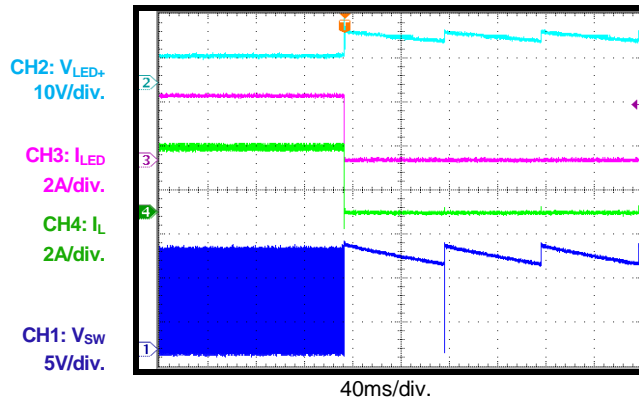
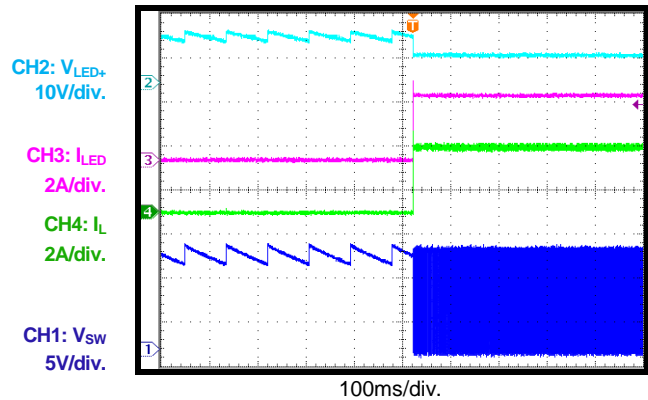
**PWM Dimming @  $f_{DIM} = 100Hz$** 

 Shutdown through  $V_{IN}$ 

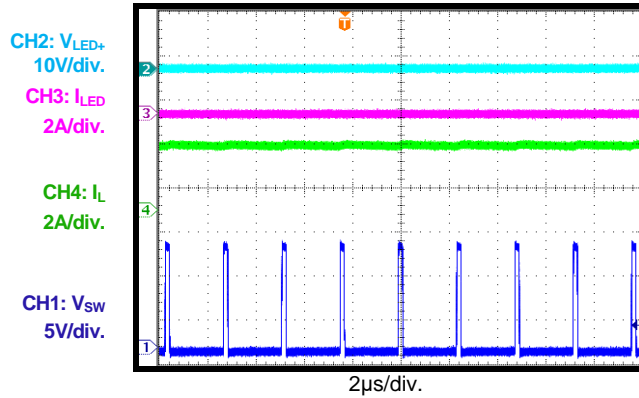
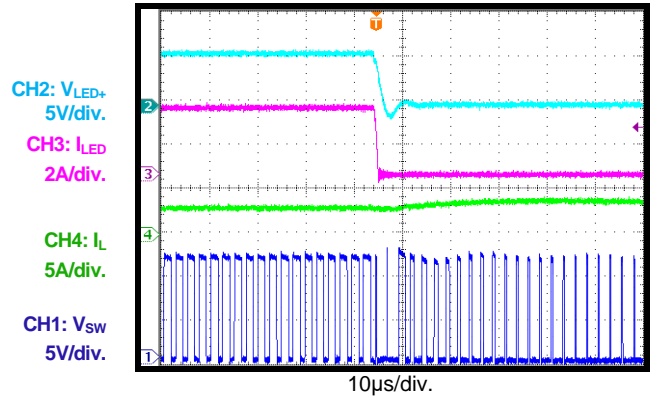
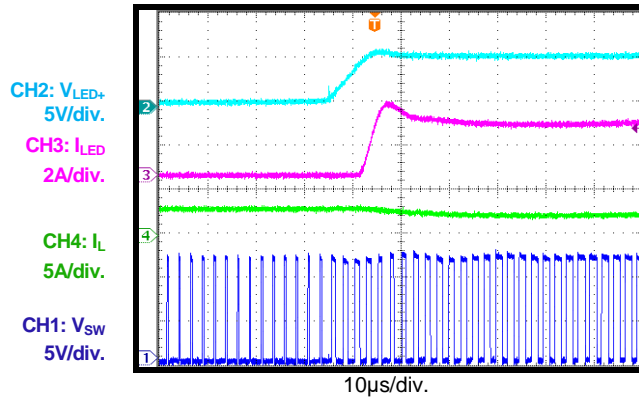
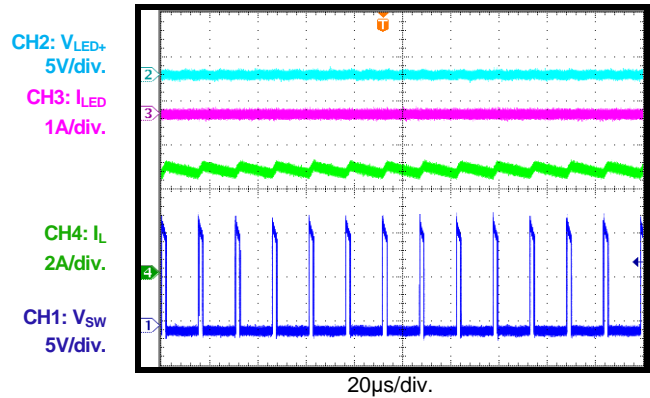
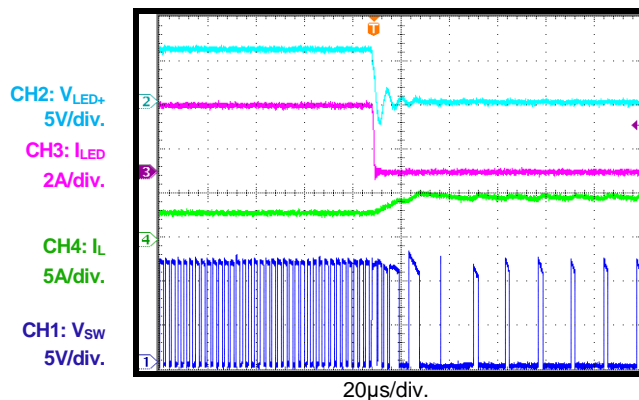
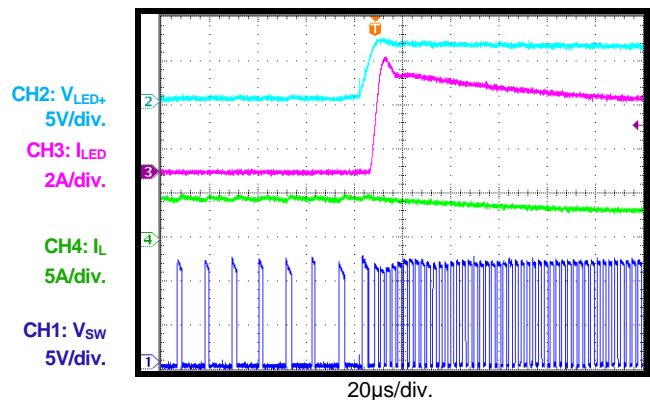
**LED Open Steady State**

**LED Open Entry**

**LED Open Recovery**

**TYPICAL PERFORMANCE CHARACTERISTICS (continued)**
 $V_{IN} = 12V$ ,  $I_{LED} = 3A$ ,  $V_{LED} = 6.2V$ ,  $L = 33\mu H$ ,  $T_A = 25^\circ C$ , buck application, unless otherwise noted.

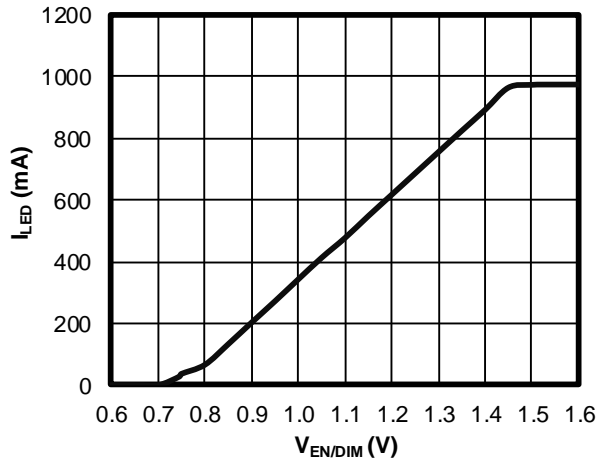
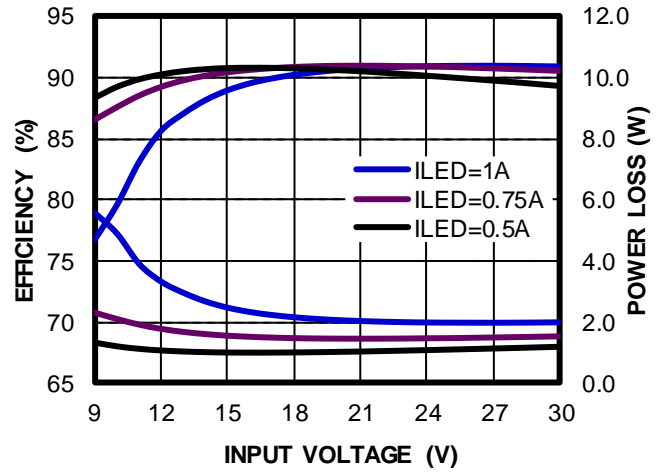
**LED+ Short to LED- Steady State**

**LED+ Short to LED- Entry**

**LED+ Short to LED- Recovery**

**LED+ Short to VSS Steady State**

**LED+ Short to VSS Entry**

**LED+ Short to VSS Recovery**

**TYPICAL PERFORMANCE CHARACTERISTICS (continued)**

$V_{IN} = 12V$ ,  $I_{LED} = 1A$ ,  $V_{LED} = 21V$ ,  $L = 33\mu H$ ,  $T_A = 25^\circ C$ , buck-boost application, unless otherwise noted.

 **$I_{LED}$  vs.  $V_{ENDIM}$** 

**Efficiency vs. Input Voltage**
 $V_{LED} = 21V$ 

**TYPICAL PERFORMANCE CHARACTERISTICS (continued)**

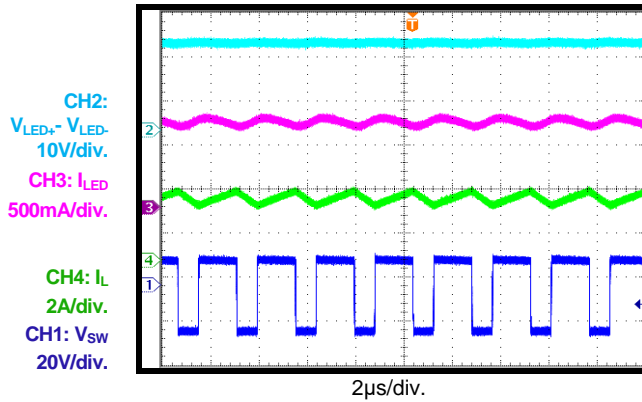
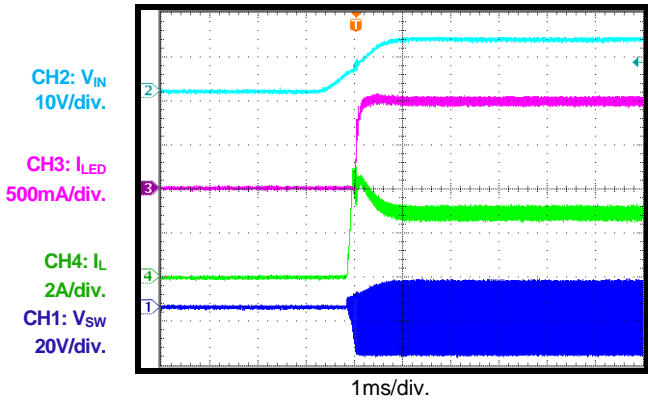
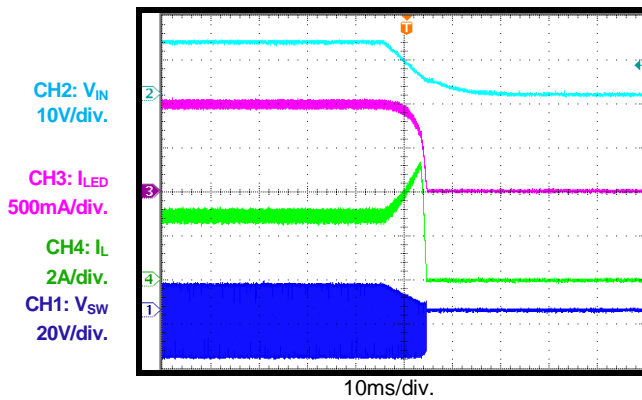
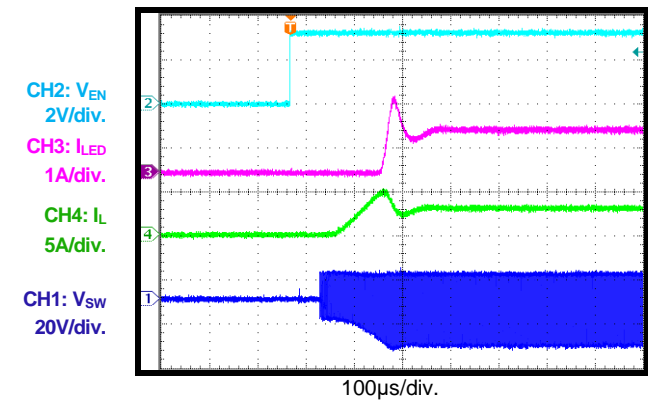
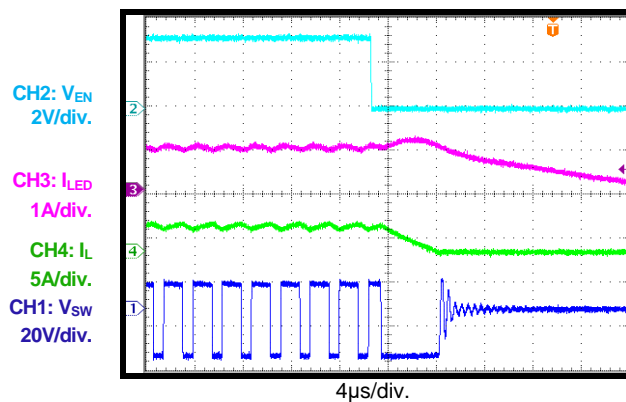
$V_{IN} = 12V$ ,  $I_{LED} = 1A$ ,  $V_{LED} = 21V$ ,  $L = 33\mu H$ ,  $T_A = 25^\circ C$ , buck-boost application, unless otherwise noted.

**Steady State**
 $I_{LED} = 1A$ 

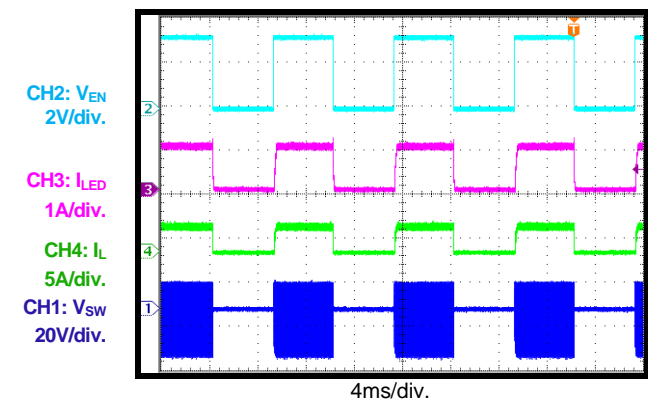
**Start-Up through  $V_{IN}$** 
 $I_{LED} = 1A$ 

**Shutdown through  $V_{IN}$** 
 $I_{LED} = 1A$ 

**Start-Up through EN**
 $I_{LED} = 1A$ 

**Shutdown through EN**
 $I_{LED} = 1A$ 

**PWM Dimming Steady State**

Dimming frequency = 100Hz



**TYPICAL PERFORMANCE CHARACTERISTICS (continued)**

$V_{IN} = 12V$ ,  $I_{LED} = 1A$ ,  $V_{LED} = 21V$ ,  $L = 33\mu H$ ,  $T_A = 25^\circ C$ , buck-boost application, unless otherwise noted.

**PWM Dimming Steady State**

Dimming frequency = 500Hz

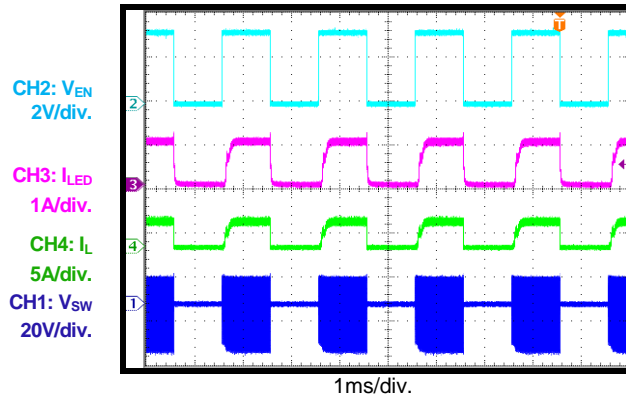

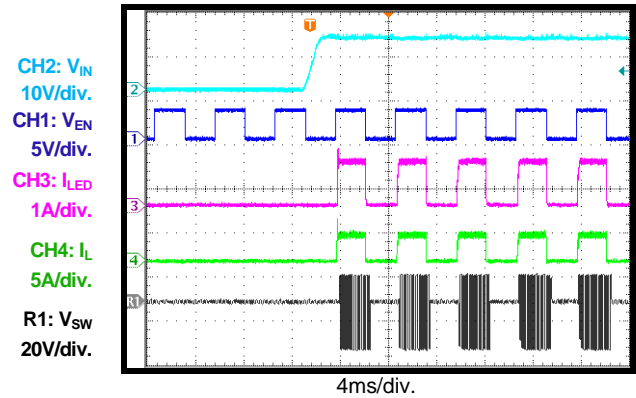
**PWM Dimming @  $f_{DIM} = 100Hz$** 

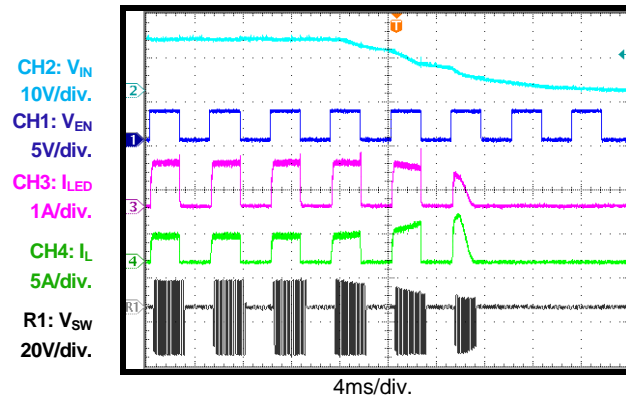
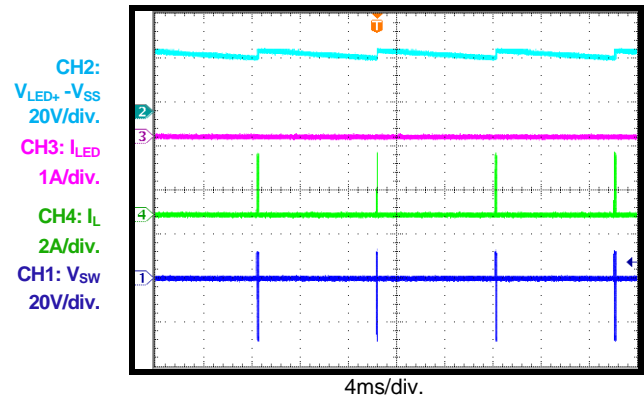
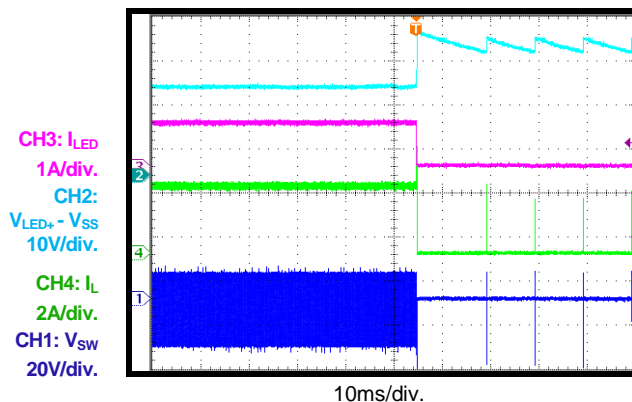
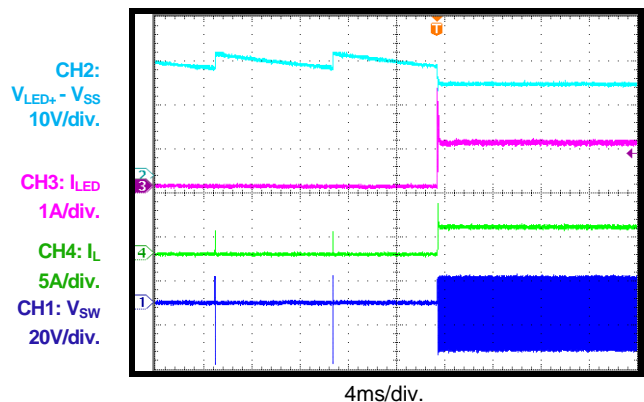
 Start-up through  $V_{IN}$ 

**PWM Dimming @  $f_{DIM} = 100Hz$** 

 Shutdown through  $V_{IN}$ 

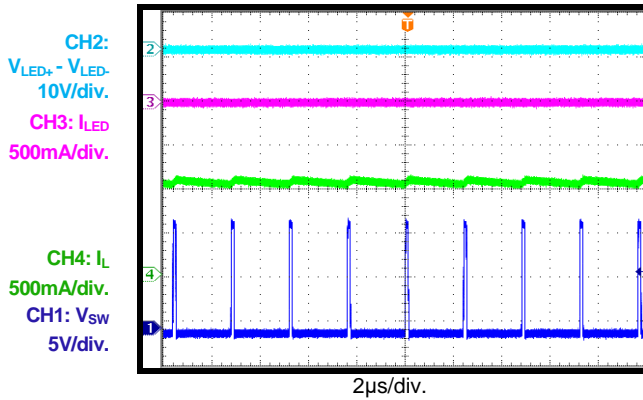
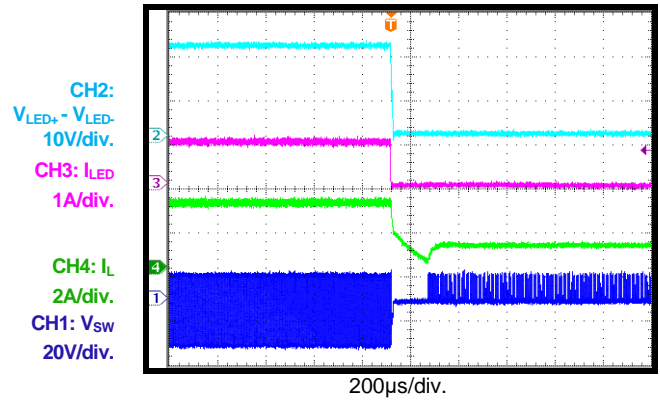
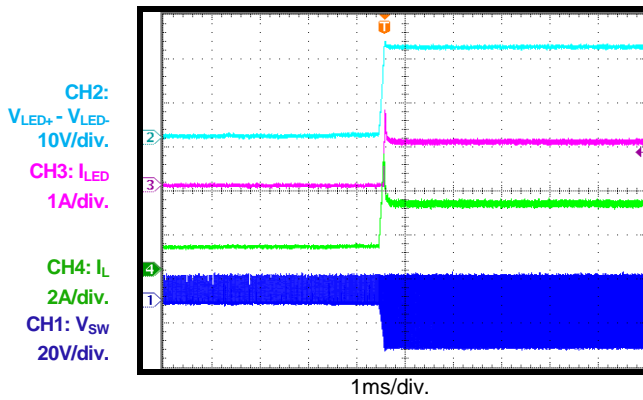
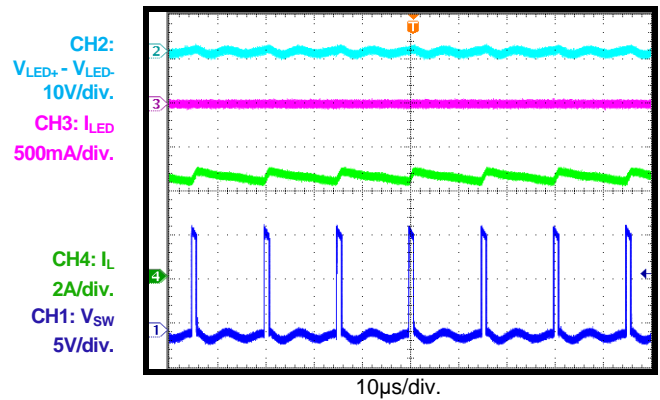
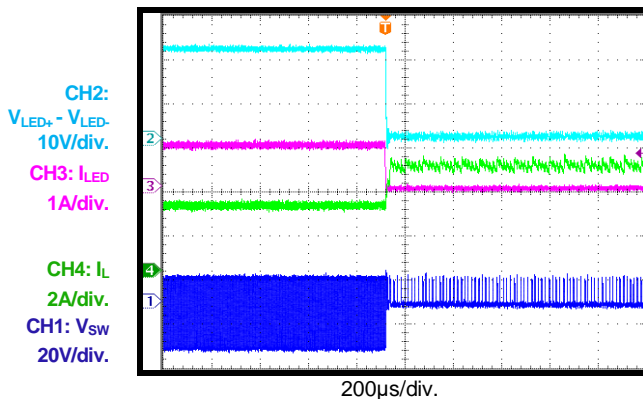
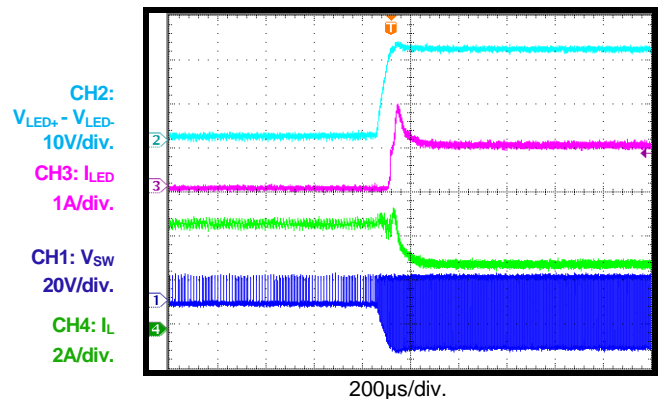
**LED Open Steady State**

**LED Open Entry**

**LED Open Recovery**

**TYPICAL PERFORMANCE CHARACTERISTICS (continued)**

$V_{IN} = 12V$ ,  $I_{LED} = 1A$ ,  $V_{LED} = 21V$ ,  $L = 33\mu H$ ,  $T_A = 25^\circ C$ , buck-boost application, unless otherwise noted.

**LED+ Short to LED- Steady State**

**LED+ Short to LED- Entry**

**LED+ Short to LED- Recovery**

**LED+ Short to VSS Steady State**

**LED+ Short to VSS Entry**

**LED+ Short to VSS Recovery**



## FUNCTIONAL BLOCK DIAGRAM

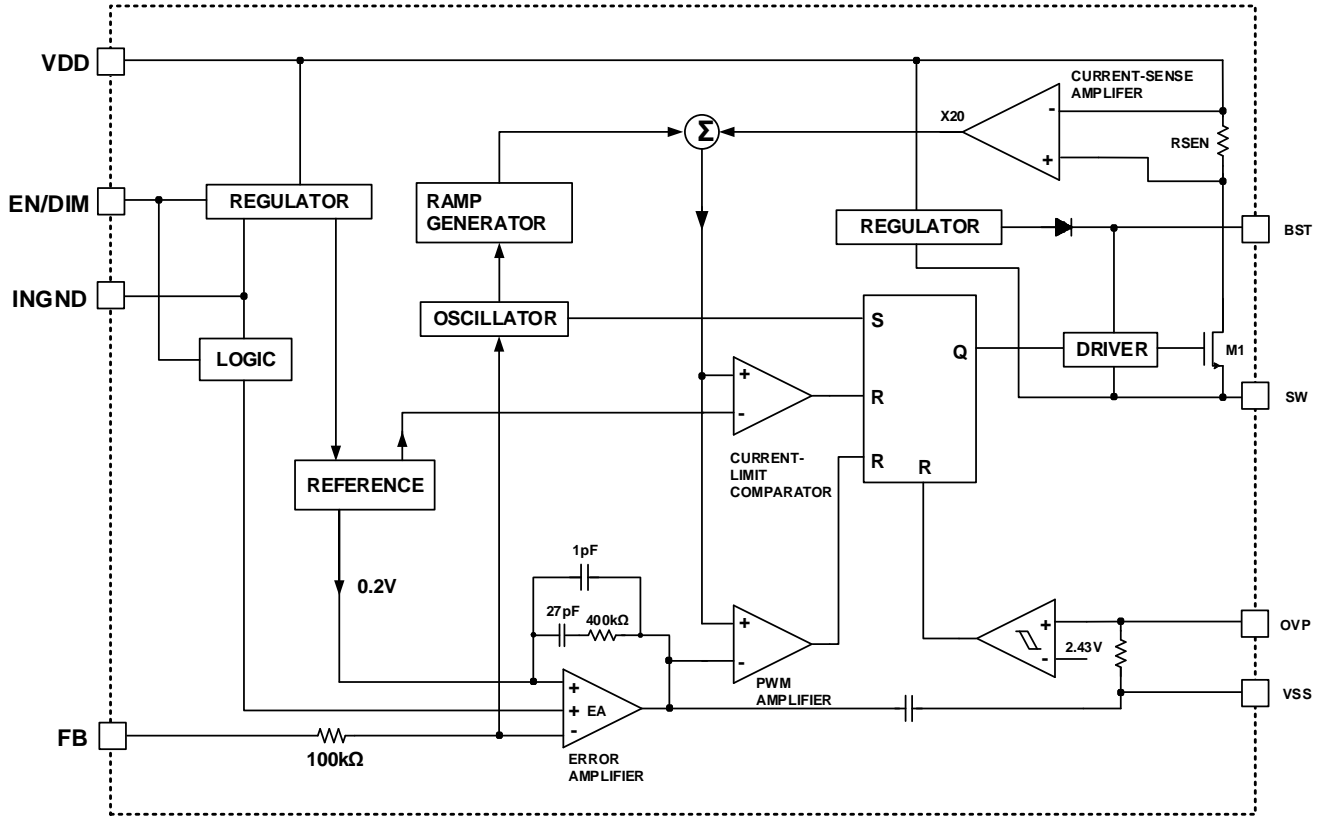

Figure 1: Functional Block Diagram

## OPERATION

The MPQ24833-B is a current-mode regulator. The error amplifier (EA) output voltage is proportional to the peak inductor current.

At the beginning of a cycle, the MOSFET is off. The EA output voltage is higher than the current-sense amplifier output, and the current comparator's output is low. The rising edge of the clock (CLK) signal sets the RS flip-flop. The CLK frequency is the operating frequency. The flip-flop output turns on the MOSFET that connects SW and the inductor to the input supply.

The current-sense amplifier detects and amplifies the rising inductor current. The PWM comparator compares the output of the EA against the sum of the ramp compensator and the current-sense amplifier. When the sum of the current-sense amplifier output and the slope compensation signal exceeds the EA output voltage, the RS flip-flop resets, and the MOSFET turns off. The external Schottky rectifier diode (D) conducts the inductor current.

If the sum of the current-sense amplifier output and the slope compensation signal does not exceed the EA output throughout the cycle, then the falling edge of the CLK resets the flip-flop.

The output of the EA integrates the voltage difference between the feedback and the 0.2V reference. The EA output increases when the FB voltage ( $V_{FB}$ ) is less than 0.2V. Since the EA output voltage is proportional to the peak inductor current, the increase in the EA output voltage also increases the current delivered to the output.

### Soft Start (SS)

When the MPQ24833-B is enabled and VDD exceeds the UVLO threshold, switching begins. Soft start is not active when  $V_{FB} - V_{SS}$  is below half of the reference voltage ( $V_{REF}$ ), which is useful for charging the output capacitor quickly. At the same time, the current limit is folded to half.

Once  $V_{FB} - V_{SS}$  rises up to half of  $V_{REF}$ , soft start begins and forces the internal reference

input of the EA to slowly rise up from  $\frac{2}{3}$  of  $V_{REF}$ . The current limit also recovers the normal value. The soft start function can make the duty cycle extend slowly to limit current overshoot at start-up.

### Open-LED Protection

The OVP pin is used for open-LED protection, and monitors the output voltage through a voltage divider. If the LED is open, there is no voltage on FB. The duty cycle increases until  $V_{OVP} - V_{SS}$  reaches the protection threshold set by the external resistor divider. The top switch turns off until  $V_{OVP} - V_{SS}$  decreases sufficiently.

### Dimming Control

The MPQ24833-B allows for both DC and PWM dimming. When the voltage on EN/DIM (reference to INGND) is below 0.75V, the chip turns off.

For analog dimming, the LED current is dependent linearly on the EN/DIM voltage range between 0.75V and 1.5V, from 0% to 100%. An EN/DIM voltage above 1.5V generates the maximum LED current.

For PWM dimming,  $V_{EN/DIM} - V_{INGND}$  must exceed 1.7V. Use a PWM frequency in the range of 100Hz to 2kHz for good dimming linearity. For combined analog and PWM dimming, apply a PWM signal with an amplitude from 0.75V to 1.5V to EN/DIM.

### Output Short-Circuit Protection (SCP)

The MPQ24833-B features output short-circuit protection (SCP). When the output is shorted to VSS, the voltage on OVP drops below 0.2V, and FB senses no voltage ( $<0.1V$ ), since no current is going through the LED. Under this condition, the operating frequency folds back to decrease power consumption.

In boost or buck-boost applications when there is a possibility that the LED+ can short-circuit to VSS, place a 100 $\Omega$  resistor in series from power GND to INGND of the IC to protect the IC.

## APPLICATION INFORMATION

### Setting the LED Current

The external resistor sets the maximum LED current (see the Typical Application Circuits section on page 22). The value of the external resistor can be determined using Equation (1):

$$R_{\text{SENSE}} = \frac{0.2V}{I_{\text{LED}}} \quad (1)$$

### Setting the Over-Voltage Protection (OVP)

The voltage divider sets the over-voltage protection (OVP) point (see the Typical Application Circuits section on page 22). Calculate  $V_{\text{OVP}}$  using Equation (2):

$$V_{\text{OVP}} = 2.43V \times \frac{R_{\text{OVP1}} + R_{\text{OVP2}}}{R_{\text{OVP2}}} \quad (2)$$

Normally, the OVP point is set about 10% to 30% higher than the LED voltage.

### Selecting the Inductor

For most applications, use an inductor with a value ranging from 10 $\mu$ H to 100 $\mu$ H with a DC current rating greater than the maximum inductor current. Include the DC resistance of the inductor when estimating the output current and the power consumption of the inductor.

For buck converter designs, derive the required inductance value with Equation (3):

$$L = \frac{V_{\text{OUT}} \times (V_{\text{IN}} - V_{\text{OUT}})}{V_{\text{IN}} \times \Delta I_L \times f_{\text{SW}}} \quad (3)$$

Choose the inductor ripple current to be 30% (usually in range of 30% to 60%) of the maximum load current. The maximum inductor peak current can be calculated with Equation (4):

$$I_{L_{\text{peak}}} = I_{L_{\text{AVG}}} + \frac{\Delta I_L}{2} \quad (4)$$

Where  $I_{L_{\text{AVG}}}$  is the average current through the inductor. It is equal to the output load current (LED current) for buck applications.

Under light-load conditions below 100mA, use a larger inductor for improved efficiency.

### Selecting the Input Capacitor

The input capacitor reduces the surge current drawn from the input supply and the switching noise from the device. Choose an input capacitor with a switching frequency impedance that is less than the input source impedance to prevent the high-frequency switching current from passing through the input. Ceramic capacitors with X7R dielectrics are recommended because of their low ESR and small temperature coefficients.

Select a capacitance that can limit the input voltage ripple ( $\Delta V_{\text{IN}}$ ), which is typically less than 5% to 10% of the DC value. For buck applications, the capacitance can be calculated with Equation (5):

$$C_{\text{IN}} > \frac{I_{\text{LED}} \times V_{\text{OUT}} \times (V_{\text{IN}} - V_{\text{OUT}})}{\Delta V_{\text{IN}} \times f_{\text{SW}} \times V_{\text{IN}}^2} \quad (5)$$

For most applications, use a 4.7 $\mu$ F capacitor.

See the Design Example section below for buck-boost applications.

### Selecting the Output Capacitor

The output capacitor keeps the output voltage ripple small and ensures a stable feedback loop. Select an output capacitor with low impedance at the switching frequency. Ceramic capacitors with X7R dielectrics are recommended because of their low ESR characteristics. For buck applications, the output capacitor can be selected using Equation (6):

$$C_{\text{OUT}} > \frac{\Delta I_L}{8\Delta V_{\text{OUT}} \times f_{\text{SW}}} \quad (6)$$

A 2.2 $\mu$ F to 10 $\mu$ F ceramic capacitor is sufficient for most applications.

See the Design Example section below for buck-boost applications.

### Design Example

Use the step-up/step-down application as an example to show the design procedure.

### Specifications

- Input: 12V, DC
- Output: LED current 1A maximum, LED voltage 21V
- Operating frequency: 420kHz

### Selecting the LED Current-Sense Resistor

Determine the LED current-sense resistor with Equation (7):

$$R_{\text{sense}} = \frac{0.2V}{I_{\text{LED}}} = 200\text{m}\Omega \quad (7)$$

Considering power consumption, use two 400mΩ resistors with 1206 packages in parallel for the LED current-sense resistor.

### Selecting the Inductor

The converter operates in continuous current mode (CCM). Determine the inductor value with Equation (8):

$$L = \frac{V_{\text{IN}} \times V_{\text{OUT}}}{(V_{\text{IN}} + V_{\text{OUT}}) \times \Delta I_L \times f_{\text{sw}}} \quad (8)$$

Where  $\Delta I_L$  is the inductor peak-to-peak current ripple. Select  $\Delta I_L$  to be 30% (usually from 30% to 60%) of the inductor average current, which can be calculated with Equation (9):

$$I_{L\_AVG} = I_{\text{LED}} \times \left(1 + \frac{V_{\text{OUT}}}{V_{\text{IN}}}\right) \quad (9)$$

The inductance is 22.04μH. Use a 33μH inductor. The current ripple of inductor is about 0.55A. The peak inductor current can be calculated with Equation (10):

$$I_{L\_peak} = I_{L\_AVG} + \frac{1}{2} \Delta I_L \quad (10)$$

The peak current is about 3.025A. Select an inductor with a saturation current of about 4A.

### Selecting the Input and Output Capacitor

The input capacitor reduces the surge current drawn from the input supply and the switching noise from the device. Select a capacitance that can limit the input voltage ripple ( $\Delta V_{\text{IN}}$ ), which is typically less than 5% to 10% of the DC value. Calculate  $C_{\text{IN}}$  with Equation (11):

$$C_{\text{IN}} > \frac{I_{\text{LED}} \times V_{\text{OUT}}}{f_{\text{sw}} \times \Delta V_{\text{IN}} \times (V_{\text{IN}} + V_{\text{OUT}})} \quad (11)$$

The output capacitor keeps the output voltage ripple ( $\Delta V_{\text{OUT}}$ ) small (typically less than 1% to 5% of the DC value) and ensures feedback loop stability. Calculate  $C_{\text{OUT}}$  with Equation (12):

$$C_{\text{OUT}} > \frac{I_{\text{LED}} \times V_{\text{OUT}}}{f_{\text{sw}} \times \Delta V_{\text{OUT}} \times (V_{\text{IN}} + V_{\text{OUT}})} \quad (12)$$

Use two 2.2μF/50V X7R ceramic capacitors in parallel as the input capacitor, and use a 4.7μF/50V X7R ceramic capacitor as the output capacitor.

### Selecting the Rectifier Diode

Use a Schottky diode as the rectifier diode. Select a diode that can withstand voltage stress greater than 55V. The diode should also have a current limit greater than the output current. Use B560 in this application.

### Setting the Over-Voltage Protection (OVP)

Set the OVP point 20% to 30% higher than the maximum output voltage by the voltage divider using Equation (13):

$$V_{\text{OVP}} = 2.43V \times \frac{R_{\text{OVP1}} + R_{\text{OVP2}}}{R_{\text{OVP2}}} \quad (13)$$

The OVP setting resistor is  $R_9 = 10\text{k}\Omega$  and  $R_8 = 100\text{k}\Omega$ .

**PCB Layout Guidelines <sup>(8)</sup>**

Efficient PCB layout is critical for stable operation. For best results, refer to Figure 2 and follow the guidelines below:

1. Place the high-current paths (VSS, VDD, and SW) close to the device with short, direct, and wide traces.
2. Place the input capacitor as close to VDD and VSS as possible.
3. Place the external feedback resistors next to FB.
4. Keep the switch node traces short and away from the feedback network.
5. Keep the switching frequency loop as small as possible.
6. Place the Schottky diode close to the IC (VDD and SW) and the input capacitor.
7. Place the output capacitor close to the IC and the input capacitor.

**Note:**

- 8) The recommended PCB layout is based on Figure 2.

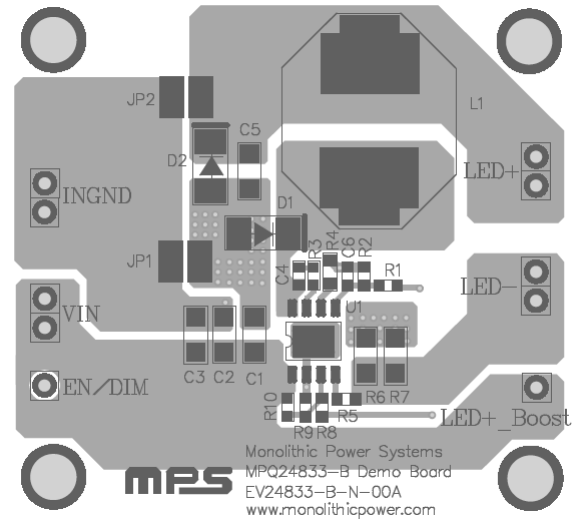
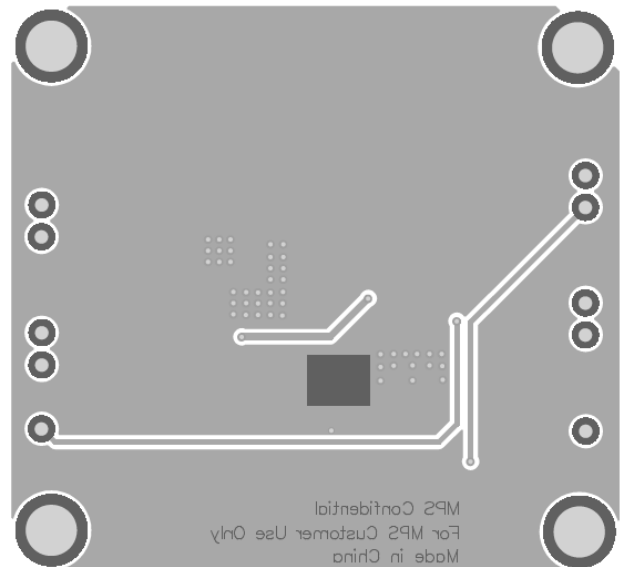
**Top Layer**

**Bottom Layer**
**Figure 2: Recommended PCB Layout**

### TYPICAL APPLICATION CIRCUITS

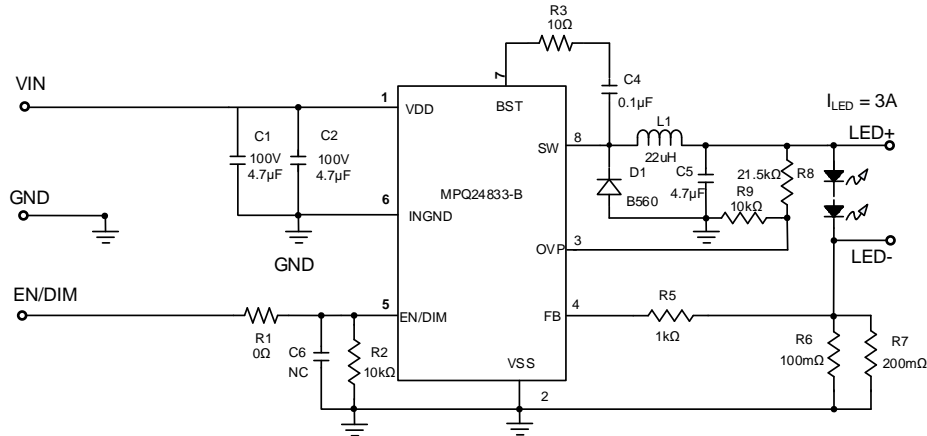

Figure 3: Typical Buck Converter Application,  $V_{IN} = 9V$  to  $20V$ ,  $V_{LED} = 6V$ ,  $I_{LED} = 3A$

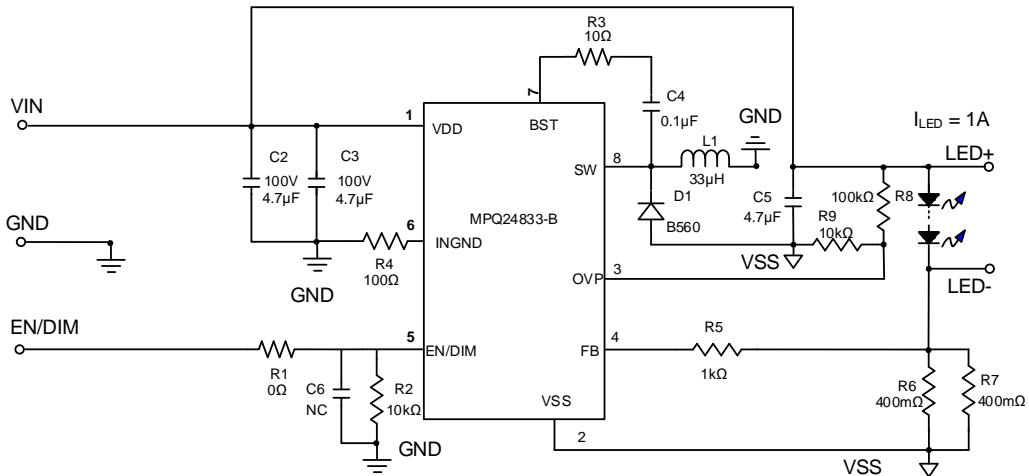

Figure 4: Typical Boost Converter Application,  $V_{IN} = 9V$  to  $20V$ ,  $V_{LED} = 21V$ ,  $I_{LED} = 1A$

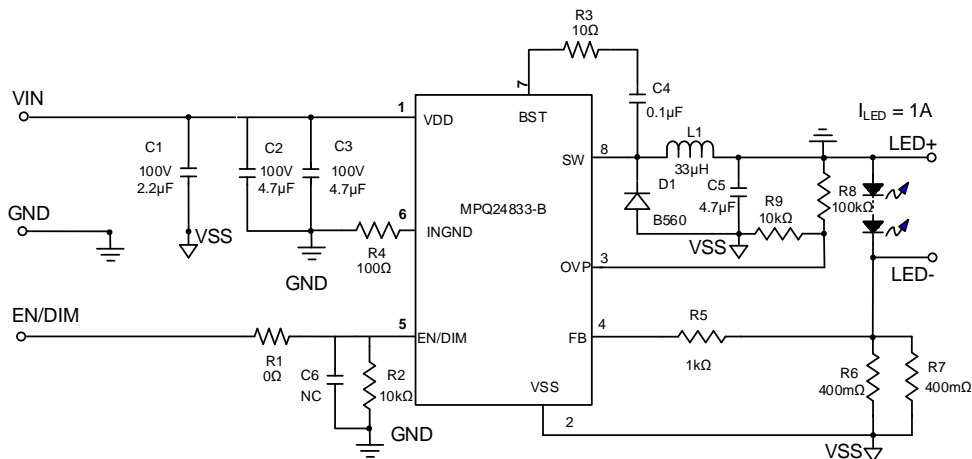
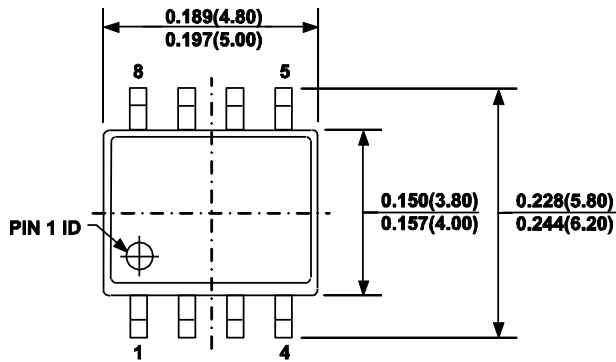

Figure 5: Typical Buck-Boost Converter Application,  $V_{IN} = 9V$  to  $20V$ ,  $V_{LED} = 21V$ ,  $I_{LED} = 1A$

## PACKAGE INFORMATION

## SOIC-8 EP



TOP VIEW

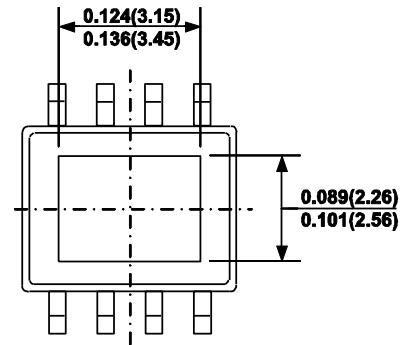

BOTTOM VIEW

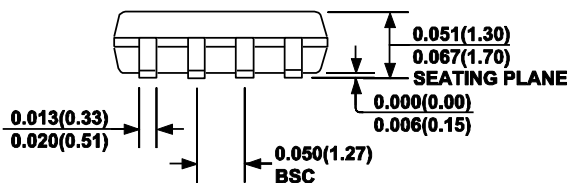

FRONT VIEW

SEE DETAIL "A"

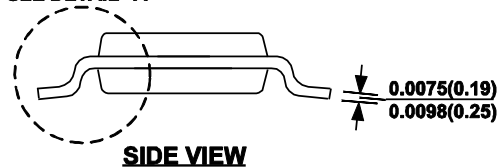

SIDE VIEW

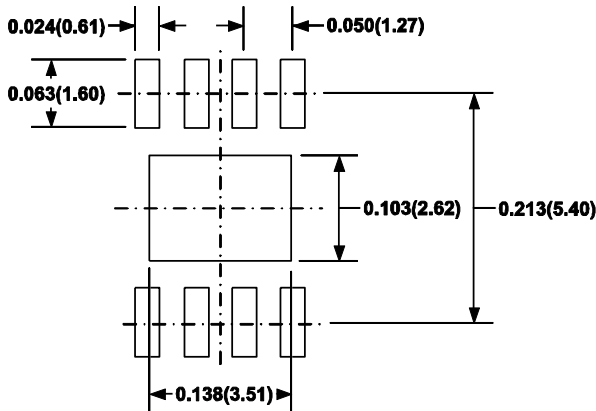

RECOMMENDED LAND PATTERN

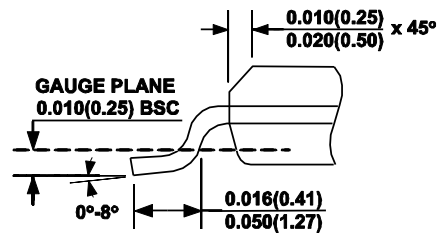

DETAIL "A"

## NOTE:

- 1) CONTROL DIMENSION IS IN INCHES. DIMENSION IN BRACKET IS IN MILLIMETERS.
- 2) PACKAGE LENGTH DOES NOT INCLUDE MOLD FLASH, PROTRUSIONS OR GATE BURRS.
- 3) PACKAGE WIDTH DOES NOT INCLUDE INTERLEAD FLASH OR PROTRUSIONS.
- 4) LEAD COPLANARITY (BOTTOM OF LEADS AFTER FORMING) SHALL BE 0.004" INCHES MAX.
- 5) DRAWING CONFORMS TO JEDEC MS-012, VARIATION BA.
- 6) DRAWING IS NOT TO SCALE.

## CARRIER INFORMATION

### SOIC-8 EP

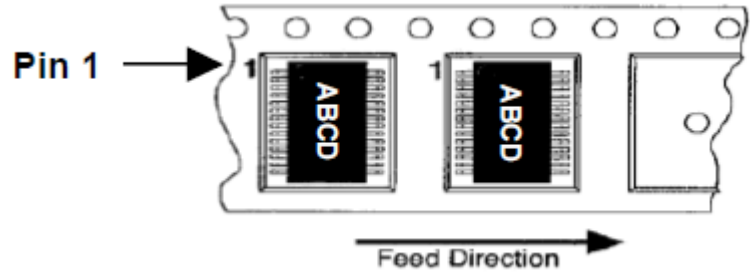
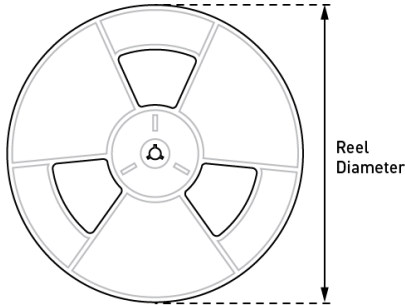

Part Number	Package Description	Quantity/Reel	Quantity/Tube	Reel Diameter	Carrier Tape Width	Carrier Tape Pitch
MPQ24833-B	SOIC-8 EP	2500	100	13in	12mm	8mm

**NOTICE:** The information in this document is subject to change without notice. Users should warrant and guarantee that third-party Intellectual Property rights are not infringed upon when integrating MPS products into any application. MPS will not assume any legal responsibility for any said applications.