

Technical Characteristics

Part Number

Han 24B Inline Kit

Hood	Top Entry
Housing	Double Lever Coupler
Material	Die Cast Aluminum
IP / NEMA	IP65 / 4, 4x, 12
Temp Rating	-40 to +125C
Cable Gland	M32 Metal
Cable Diameter	13-20mm / 18-25mm
Insert	Han 24E, 24+GND
Screw Terminals	18-14AWG
Wire Strip Length	7.5mm
Mating Cycles	>500
Flammability	V-0

73 10 100 0031

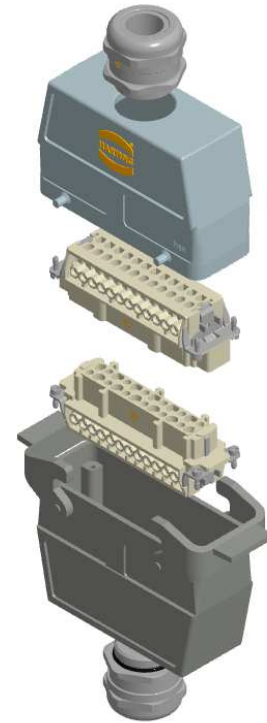

Electrical Characteristics

Rated Current	16amps
Rated Voltage	600V
Rated Impulse Voltage	6kV

Drawings and Assembly Information

Dimensions in mm

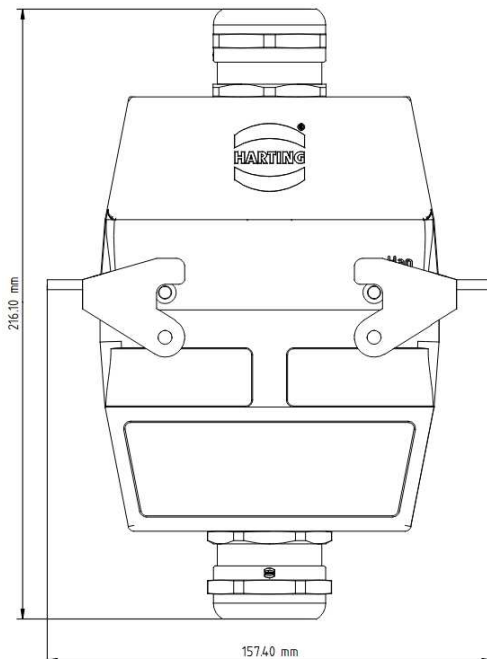

Tooling and Torque Values

Type	Tool	Torque (Nm)
Terminal Screws (M3)	PH1 or Slotted 0.6 x 3.5	0.50
Fixing Screw (M3)	PH2 or Slotted 0.6 x 3.5	0.50
Cable Gland (M32)	SW 40	15

Kit Contents

Male Insert	09 33 024 2601
Female insert	09 33 024 2701
Housing	19 30 024 0737
Hood	19 30 024 0427
Cable Gland (x2)	19 00 000 5095

For further information, please reach out to techsupportUS@HARTING.com