

| ITEM | Q'TY | PART NUMBER | PART DESCRIPTION |
|------|------|-------------|--|
| 1 | 1 | H-278C-2 | T-1¼ (5mm) Bi-Level LED Holder, 90° Mount |
| 2 | 2 | 5XX | T-1¼ (5mm) Non-Flange LED, See Following Pages |

| REV. | DESCRIPTION | DATE | APPROVED |
|------|---|----------|----------|
| C | Corrected Holder from H-278C to H-278C-1. | 02/28/05 | M. C. |
| D | Changed Holder from H-278C-1 to H-278C-2. | 02/14/07 | M. C. |
| E | Changed LED Protrusion from .180 to .170 | 02/27/07 | M. C. |
| F | Added P/N Designation Note | 03/04/09 | T. Y. |
| G | Added H278CGAD | 05/29/12 | T. Y. |
| H | Updated LED Offering List | 06/19/12 | T. Y. |
| J | Updated LED Optical Characteristics | 09/15/15 | J. C. |

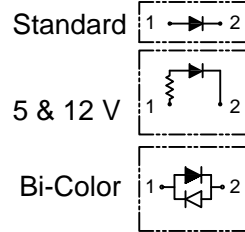
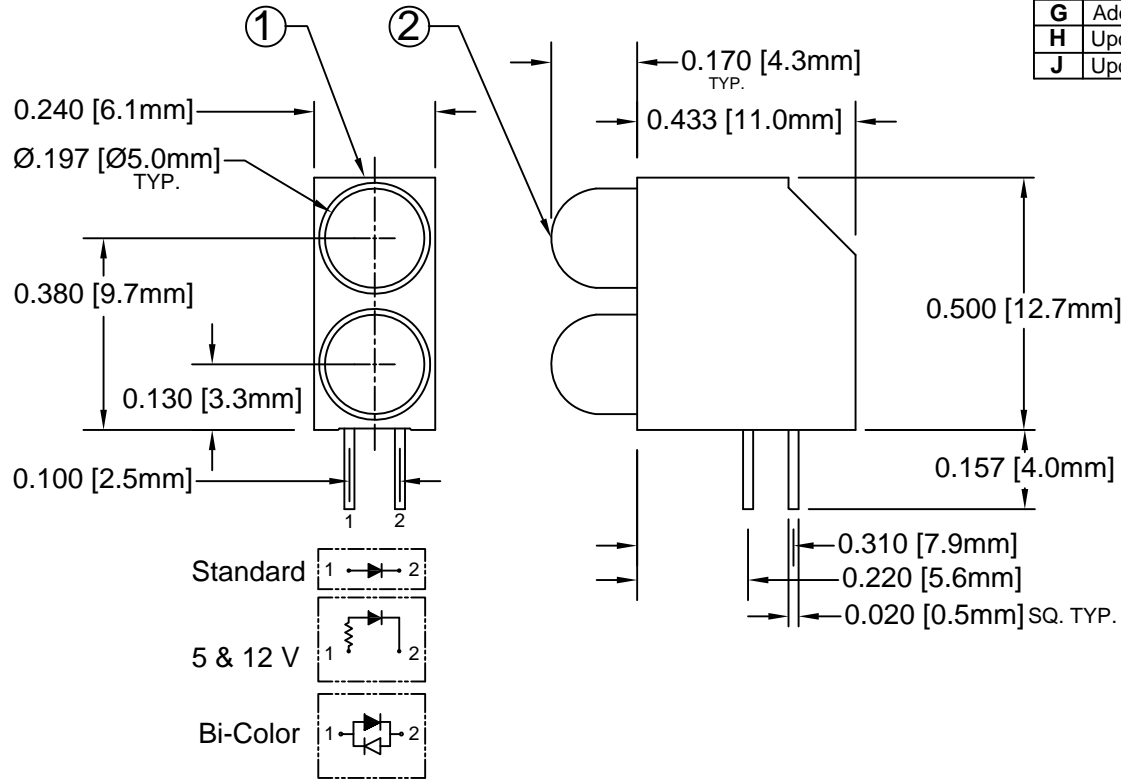

| BI-COLOR POLARITY | | |
|-------------------|-------------|-------------|
| LED P/N | (1) Cathode | (2) Cathode |
| 5BC | Green | Red |
| 5BC-Y/G | Green | Yellow |
| 5BC-R/Y | Yellow | Red |
| 5BC-A/G | Green | Amber |

NOTE: P/N CONFIGURATION

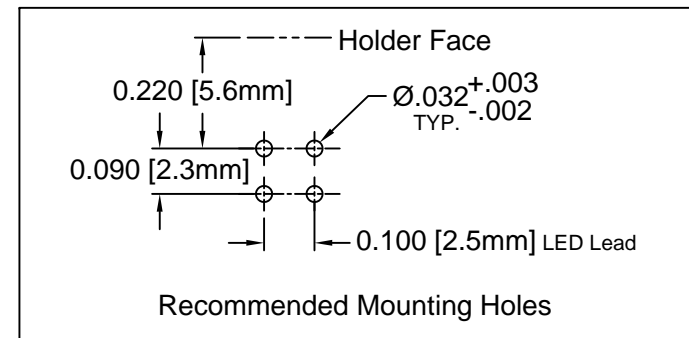
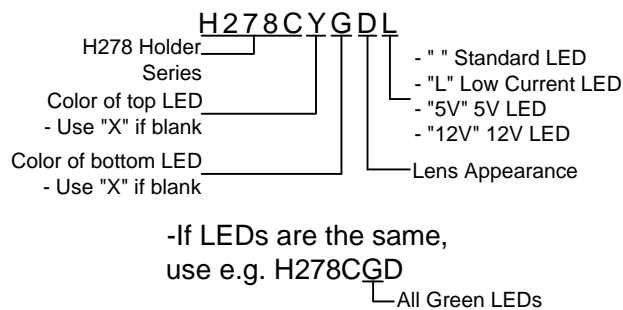

ABSOLUTE MAXIMUM RATINGS (Ta=25° C)

| | |
|---|----------------------|
| REVERSE VOLTAGE _____ | 5V |
| REVERSE CURRENT _____ | 100uA |
| OPERATING TEMPERATURE RANGE _____ | -25° C - 85° C |
| STORAGE TEMPERATURE _____ | -30° C - 100° C |
| LEAD SOLDERING TEMPERATURE(1/16" FROM BODY) _____ | 260° C FOR 5 SECONDS |

| | | | | | |
|---|---------|--|--|---|---|
| STANDARD TOLERANCE (UNLESS OTHERWISE SPECIFIED) | | 4 THOMAS, IRVINE, CA. 92618 TEL: (949) 951-8808 FAX: (949) 951-3974 | | | |
| DECIMALS | ANGULAR | | | | |
| .X ± .1 | X° ± 1° | TITLE: T-1¼ (5MM) 90° BI-LEVEL LED ASSY | | | |
| .XX ± .02 | | | | | |
| .XXX ± .010 | | DESIGNED: T. Yin CHECKED: D. Green | DATE: 03/05/04 DATE: 03/05/04 | PART NO: H278CXX CAGE CODE : 32559 | REVISION: J SHEET # 1 OF 4 |
| CAD GENERATED DOCUMENT. DO NOT MEASURE DRAWING. | | | | | |

| | | | |
|------|--------------|------|----------|
| REV. | DESCRIPTION | DATE | APPROVED |
| | SEE SHEET#1. | | |

| LED Assy. No. | Chip | | | Lens Appearance | Electro-Optical Data @ 20mA | | | | Viewing Angle 2 θ ½ (Deg) | LED P/N |
|---------------|-----------|------------------|---------------|-----------------|-----------------------------|--------|-----|----------|---------------------------------|---------|
| | Material | Peak Wave Length | Emitted Color | | If (mA) | Vf (V) | | Iv (mcd) | | |
| | | | | | MAX | TYP | MAX | TYP | | |
| H278CBWC | GaN/SiC | 430 | BLUE | WATER CLEAR | 25 | 4.0 | 4.5 | 25 | 20 | 5BWC |
| H278CBWD | GaN/SiC | 430 | BLUE | DIFFUSED | 25 | 4.0 | 4.5 | 15 | 45 | 5BWD |
| H278CBWT | GaN/SiC | 430 | BLUE | TINTED | 25 | 4.0 | 4.5 | 30 | 20 | 5BWT |
| H278CGC | GaP/GaP | 568 | GREEN | WATER CLEAR | 30 | 2.1 | 2.8 | 40 | 35 | 5GC |
| H278CGD | GaP/GaP | 568 | GREEN | DIFFUSED | 30 | 2.1 | 2.8 | 25 | 45 | 5GD |
| H278CGT | GaP/GaP | 568 | GREEN | TINTED | 30 | 2.1 | 2.8 | 40 | 35 | 5GT |
| H278CUGC | AlGaInP | 570 | GREEN | WATER CLEAR | 30 | 2.1 | 2.4 | 600 | 35 | 5UGC |
| H278CPGC | GaP/GaP | 555 | PURE GREEN | WATER CLEAR | 30 | 2.2 | 2.8 | 10 | 35 | 5PGC |
| H278CPGD | GaP/GaP | 555 | PURE GREEN | DIFFUSED | 30 | 2.2 | 2.8 | 10 | 45 | 5PGD |
| H278CPGT | GaP/GaP | 555 | PURE GREEN | TINTED | 30 | 2.2 | 2.8 | 10 | 35 | 5PGT |
| H278CYC | GaAsP/GaP | 590 | YELLOW | WATER CLEAR | 30 | 2.0 | 2.8 | 40 | 35 | 5YC |
| H278CYD | GaAsP/GaP | 590 | YELLOW | DIFFUSED | 30 | 2.0 | 2.8 | 25 | 45 | 5YD |
| H278CYT | GaAsP/GaP | 590 | YELLOW | TINTED | 30 | 2.0 | 2.8 | 40 | 35 | 5YT |
| H278CAC | GaAsP/GaP | 605 | AMBER | WATER CLEAR | 30 | 2.0 | 2.8 | 40 | 35 | 5AC |
| H278CAD | GaAsP/GaP | 605 | AMBER | DIFFUSED | 30 | 2.0 | 2.8 | 25 | 45 | 5AD |
| H278CAT | GaAsP/GaP | 605 | AMBER | TINTED | 30 | 2.0 | 2.8 | 40 | 35 | 5AT |
| H278CHC | GaAsP/GaP | 625 | HE RED | WATER CLEAR | 30 | 2.0 | 2.8 | 40 | 35 | 5HC |
| H278CHD | GaAsP/GaP | 625 | HE RED | DIFFUSED | 30 | 2.0 | 2.8 | 25 | 45 | 5HD |
| H278CHT | GaAsP/GaP | 625 | HE RED | TINTED | 30 | 2.0 | 2.8 | 40 | 35 | 5HT |
| H278CRC | GaP/GaP | 700 | RED | WATER CLEAR | 20 | 2.1 | 2.8 | 2 | 35 | 5RC |
| H278CRD | GaP/GaP | 700 | RED | DIFFUSED | 20 | 2.1 | 2.8 | 2 | 45 | 5RD |
| H278CRT | GaP/GaP | 700 | RED | TINTED | 20 | 2.1 | 2.8 | 2 | 35 | 5RT |
| H278CBC-A/G | GaAsP/GaP | 605 | AMBER | WHITE DIFFUSED | 30 | 2.0 | 2.8 | 6 | 45 | 5BC-A/G |
| | GaP/GaP | 568 | GREEN | | 30 | 2.1 | 2.8 | 6 | | |
| H278CBC | GaAsP/GaP | 625 | RED | WHITE DIFFUSED | 30 | 2.0 | 2.8 | 6 | 45 | 5BC |
| | GaP/GaP | 568 | GREEN | | 30 | 2.1 | 2.8 | 8 | | |
| H278CBC-R/Y | GaAsP/GaP | 625 | RED | WHITE DIFFUSED | 30 | 2.0 | 2.8 | 6 | 45 | 5BC-R/Y |
| | GaAsP/GaP | 590 | YELLOW | | 30 | 2.0 | 2.8 | 5 | | |
| H278CBC-Y/G | GaAsP/GaP | 590 | YELLOW | WHITE DIFFUSED | 30 | 2.0 | 2.8 | 5 | 45 | 5BC-Y/G |
| | GaP/GaP | 568 | GREEN | | 30 | 2.1 | 2.8 | 8 | | |

| | | | |
|---|--------------------------|---|-----------------------|
| STANDARD TOLERANCE (UNLESS OTHERWISE SPECIFIED) ±10% ALL VALUES | |  4 THOMAS, IRVINE, CA. 92618 TEL: (949) 951-8808 FAX: (949) 951-3974 | |
| ANGULAR X° ± 5° | | TITLE: T-1¾ (5MM) 90° BI-LEVEL LED ASSY | |
| DESIGNED: T. Yin | DATE: 03/05/04 | PART NO: H278CXX | REVISION: J |
| CHECKED: D. Green | DATE: 03/05/04 | CAGE CODE : 32559 | SHEET # 2 OF 4 |
| CAD GENERATED DOCUMENT. DO NOT MEASURE DRAWING. | | | |

| | | | |
|------|--------------|------|----------|
| REV. | DESCRIPTION | DATE | APPROVED |
| | SEE SHEET#1. | | |
| | | | |

| LED Assy. No. | Chip | | | Lens Appearance | Electro-Optical Data @ 20mA | | | | Viewing Angle 2 θ ½ (Deg) | LED P/N |
|---------------|-------------|------------------|---------------|-----------------|-----------------------------|--------|-----|----------|---------------------------------|-----------|
| | Material | Peak Wave Length | Emitted Color | | If (mA) | Vf (V) | | Iv (mcd) | | |
| | | | | | | MAX | TYP | | | |
| H278CUBWC | InGaN/SiC | 468 | BLUE | WATER CLEAR | 50 | 3.2 | 3.6 | 5000 | 15 | 5BWC2.515 |
| H278CSGC | GaP/GaP | 568 | GREEN | WATER CLEAR | 30 | 2.1 | 2.8 | 60 | 35 | 5SGC |
| H278CSGD | GaP/GaP | 568 | GREEN | DIFFUSED | 30 | 2.1 | 2.8 | 50 | 45 | 5SGD |
| H278CSGT | GaP/GaP | 568 | GREEN | TINTED | 30 | 2.1 | 2.8 | 60 | 35 | 5SGT |
| H278CSYC | GaAsP/GaP | 590 | YELLOW | WATER CLEAR | 30 | 2.0 | 2.8 | 600 | 35 | 5SYC |
| H278CSYD | GaAsP/GaP | 590 | YELLOW | DIFFUSED | 30 | 2.0 | 2.8 | 150 | 45 | 5SYD |
| H278CSYT | GaAsP/GaP | 590 | YELLOW | TINTED | 30 | 2.0 | 2.8 | 600 | 35 | 5SYT |
| H278CSRC | GaAlAs/GaAs | 645 | SUPER RED | WATER CLEAR | 30 | 1.7 | 2.4 | 60 | 35 | 5SRC |
| H278CSRD | GaAlAs/GaAs | 645 | SUPER RED | DIFFUSED | 30 | 1.7 | 2.4 | 40 | 45 | 5SRD |
| H278CSRT | GaAlAs/GaAs | 645 | SUPER RED | TINTED | 30 | 1.7 | 2.4 | 60 | 35 | 5SRT |
| H278CUGC | AlGaInP | 570 | GREEN | WATER CLEAR | 30 | 2.1 | 2.4 | 400 | 35 | 5UGC |
| H278CSUGC | AlGaInP | 570 | GREEN | WATER CLEAR | 30 | 2.1 | 2.4 | 300 | 35 | 5SUGC |
| H278CUYC | AlGaInP | 590 | YELLOW | WATER CLEAR | 30 | 2.0 | 2.4 | 1000 | 30 | 5UYC |
| H278CSUYC | AlGaInP | 590 | YELLOW | WATER CLEAR | 30 | 2.0 | 2.4 | 700 | 35 | 5SUYC |
| H278CUUYC | AlGaInP | 590 | YELLOW | WATER CLEAR | 30 | 2.0 | 2.4 | 500 | 35 | 5UUYC |
| H278CUOC | AlGaInP | 625 | ORANGE | WATER CLEAR | 30 | 1.8 | 2.4 | 1400 | 35 | 5UOC |
| H278CUOC | AlGaInP | 625 | ORANGE | WATER CLEAR | 30 | 1.8 | 2.4 | 1300 | 35 | 5SUOC |
| H278CURC | GaAlAs/GaAs | 645 | RED | WATER CLEAR | 30 | 1.7 | 2.4 | 400 | 30 | 5URC |
| H278CSURC | AlGaInP | 640 | RED | WATER CLEAR | 30 | 1.8 | 2.4 | 500 | 35 | 5SURC |
| H278CUWC | InGaN/SiC | 6500K | WHITE | WATER CLEAR | 100 | 3.5 | 4.2 | 2700 | 30 | 5WC2.730 |

| | | | |
|---|--|--|--|
| STANDARD TOLERANCE (UNLESS OTHERWISE SPECIFIED) ±10% ALL VALUES | |  BIVAR [®] 4 THOMAS, IRVINE, CA. 92618 TEL: (949) 951-8808 FAX: (949) 951-3974 | |
| ANGULAR X° ± 5° | | | |
| DESIGNED: T. Yin | | DATE: 03/05/04 | TITLE: T-1¾ (5MM) 90° BI-LEVEL LED ASSY |
| CHECKED: D. Green | | DATE: 03/05/04 | PART NO: H278CXX REVISION: J |
| | | CAGE CODE : 32559 | SHEET # 3 OF 4 |
| CAD GENERATED DOCUMENT. DO NOT MEASURE DRAWING. | | | |

| | | | |
|------|--------------|------|----------|
| REV. | DESCRIPTION | DATE | APPROVED |
| | SEE SHEET#1. | | |

| LED Assy. No. | Peak Wave Length λ_p (nm) | Emitted Color | Lens Appearance | Max. Rating | Electro-Optical Data @ 2mA | | | Viewing Angle 2 θ 1/2 (Deg) | LED P/N |
|---------------|--------------------------------------|---------------|-----------------|-------------|----------------------------|-----|-------------|--|---------|
| | | | | If (mA) | Vf (V) | | Iv (mcd) | | |
| | | | | MAX | TYP | MAX | TYP | | |
| H278CBWDL | 430 | BLUE | DIFFUSED | 7 | 3.8 | 4.2 | 4 | 45 | 5BWDL |
| H278CPGDL | 555 | PURE GREEN | DIFFUSED | 7 | 2.1 | 2.6 | 1 | 45 | 5PGDL |
| H278CGDL | 568 | GREEN | DIFFUSED | 7 | 2.1 | 2.6 | 4 | 45 | 5GDL |
| H278CYDL | 590 | YELLOW | DIFFUSED | 7 | 2.0 | 2.6 | 4 | 45 | 5YDL |
| H278CADL | 605 | AMBER | DIFFUSED | 7 | 2.0 | 2.6 | 4 | 45 | 5ADL |
| H278CHDL | 625 | HE RED | DIFFUSED | 7 | 2.0 | 2.6 | 5 | 45 | 5HDL |
| H278CSRDL | 645 | SUPER RED | DIFFUSED | 7 | 1.7 | 2.3 | 6 | 45 | 5SRDL |

| LED Assy. No. | Peak Wave Length λ_p (nm) | Emitted Color | Lens Appearance | Electro-Optical Data | | | | Viewing Angle 2 θ 1/2 (Deg) | LED P/N |
|----------------|--------------------------------------|---------------|-----------------|----------------------|-----------|-----|-------------|--|---------|
| | | | | If (mA) | Vf (V) | | Iv (mcd) | | |
| | | | | MAX | TYP | MAX | TYP | | |
| 5 Volt | | | | Data @ 5V | | | | | |
| H278CBWD5V | BLUE | 430 | DIFFUSED | - | - | 5 | 15 | 45 | 5BWD5V |
| H278CGC5V | GREEN | 568 | WATER CLEAR | - | - | 5 | 40 | 35 | 5GC5V |
| H278CGD5V | GREEN | 568 | DIFFUSED | - | - | 5 | 25 | 45 | 5GD5V |
| H278CGT5V | GREEN | 568 | TINTED | - | - | 5 | 40 | 35 | 5GT5V |
| H278CAD5V | AMBER | 605 | DIFFUSED | - | - | 5 | 25 | 45 | 5AD5V |
| H278CHD5V | HE RED | 625 | DIFFUSED | - | - | 5 | 30 | 45 | 5HD5V |
| H278CRD5V | RED | 700 | DIFFUSED | - | - | 5 | 1.5 | 45 | 5RD5V |
| H278CYD5V | YELLOW | 590 | DIFFUSED | - | - | 5 | 25 | 45 | 5YD5V |
| 12 Volt | | | | Data @ 12V | | | | | |
| H278CGC12V | GREEN | 568 | WATER CLEAR | - | - | 12 | 40 | 35 | 5GC12V |
| H278CGD12V | GREEN | 568 | DIFFUSED | - | - | 12 | 25 | 45 | 5GD12V |
| H278CHC12V | HE RED | 625 | WATER CLEAR | - | - | 12 | 50 | 35 | 5HC12V |
| H278CHD12V | HE RED | 625 | DIFFUSED | - | - | 12 | 30 | 45 | 5HD12V |
| H278CRC12V | RED | 700 | WATER CLEAR | - | - | 12 | 2 | 35 | 5RC12V |
| H278CRD12V | RED | 700 | DIFFUSED | - | - | 12 | 1.5 | 45 | 5RD12V |
| H278CYC12V | YELLOW | 590 | WATER CLEAR | - | - | 12 | 25 | 35 | 5YC12V |
| H278CYD12V | YELLOW | 590 | DIFFUSED | - | - | 12 | 20 | 45 | 5YD12V |

| | | | | |
|---|--|----------------------------|--|--|
| STANDARD TOLERANCE (UNLESS OTHERWISE SPECIFIED) $\pm 10\%$ ALL VALUES | | ANGULAR X° \pm 5° | |  BIVAR [®] 4 THOMAS, IRVINE, CA. 92618 TEL: (949) 951-8808 FAX: (949) 951-3974 |
| DESIGNED: T. Yin | | DATE: 03/05/04 | | |
| CHECKED: D. Green | | DATE: 03/05/04 | | TITLE: T-1 1/4 (5MM) 90° BI-LEVEL LED ASSY |
| | | PART NO: H278CXX | | REVISION: J |
| | | CAGE CODE : 32559 | | SHEET # 4 OF 4 |
| CAD GENERATED DOCUMENT. DO NOT MEASURE DRAWING. | | | | |