

CKT SIZE	① HOUSING	② TPA	③ POWER TERMINAL	④ SIGNAL TERMINAL	⑤ SIGNAL HOUSING (3 OF EA REQ'D)	DIMENSION 'A'	DIMENSION 'B'	DIMENSION 'C'	DIMENSION 'D'	DIMENSION 'E'
	MATERIAL: PBT, FILLED	MATERIAL: PBT, FILLED	MATERIAL: COPPER ALLOY FINISH: TIN OVER NICKEL W/SELECT GOLD	MATERIAL: PHOS. BRONZE FINISH: TIN OVER NICKEL W/SELECT GOLD	MATERIAL: NYLON, UNFILLED					
2P-12S	172512-3212	46708-3212	173693-****	70058-****	46709-0004	63.81	55.01	26.48	12.37	43.74
2P-18S	172512-3218	46708-3218	173693-****	70058-****	46709-0006	68.89	60.09	31.80	17.44	48.82
2P-24S	172512-3224	46708-3224	173693-****	70058-****	46709-0008	73.97	65.17	36.85	22.53	53.90
4P-12S	172512-3412	46708-3412	173693-****	70058-****	46709-0004	78.81	70.01	41.48	12.37	58.74
4P-18S	172512-3418	46708-3418	173693-****	70058-****	46709-0006	83.89	75.09	46.80	17.44	63.82
4P-24S	172512-3424	46708-3424	173693-****	70058-****	46709-0008	88.97	80.17	51.85	22.53	68.90
6P-12S	172512-3612	46708-3612	173693-****	70058-****	46709-0004	93.81	85.01	55.73	12.37	73.74
6P-18S	172512-3618	46708-3618	173693-****	70058-****	46709-0006	98.89	90.09	61.85	17.44	78.82
6P-24S	172512-3624	46708-3624	173693-****	70058-****	46709-0008	103.97	95.17	66.93	22.53	83.90

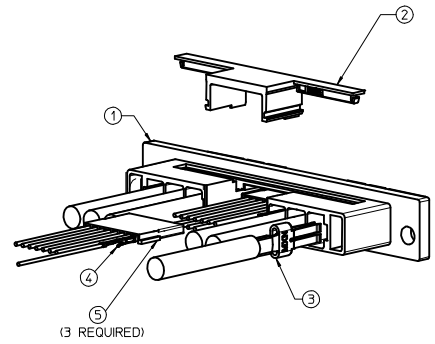

EXPLODED VIEW

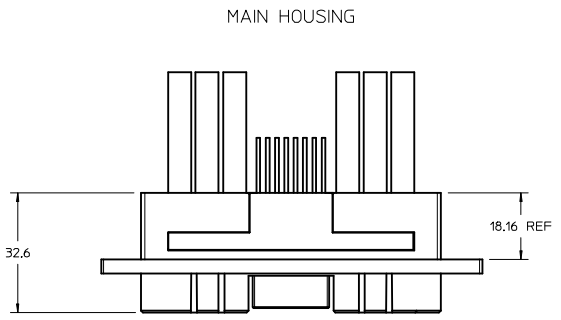

MAIN HOUSING

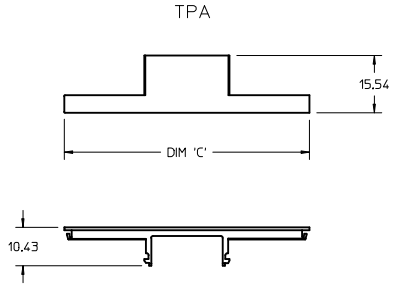

TPA

SIGNAL HOUSING

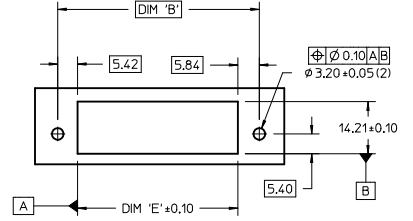
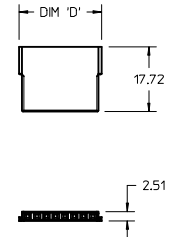

PANEL CUTOUT
(FRONT VIEW)

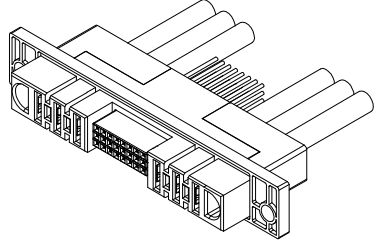
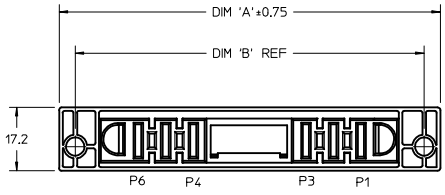

- NOTES:
- SEE CHART FOR MATERIAL DETAILS
 - PART MATES TO MOLEX PLUG SERIES 172458.
 - ASSEMBLY SHOWN FOR REFERENCE ONLY. EACH ITEM HAS TO BE ORDERED SEPARATELY.
 - PANEL MOUNTING HARDWARE: (2) M3 X 0.5 X 4.00 LG PRECISION SHOULDER SCREWS AND (2) M3 X 0.5 HEX NUTS TO BE PURCHASED SEPARATELY BY CUSTOMER.
 - SEE SD-173693-001 FOR POWER TERMINAL DETAILS.
 - SEE SD-70058-*** FOR SIGNAL TERMINAL DETAILS.

CHG TRMNL P/N EC NO: UCP2016-4071 DRAWN: JSCHAER 2016/04/18 CHKD: APPR: BPISZCZOR 2016/10/03	QUALITY SYMBOLS	GENERAL TOLERANCES (UNLESS SPECIFIED)	DIMENSION STYLE	SCALE	DESIGN UNITS	THIRD ANGLE PROJECTION
	▽=0	mm INCH	MM ONLY	1.5:1	METRIC	
	▽=0	4 PLACES ± ---				
	▽=0	3 PLACES ± 0.13				
		ANGULAR ±1/2°	DRAWN BY	DATE	TITLE	
		DRAFT WHERE APPLICABLE MUST REMAIN WITHIN DIMENSIONS	JSCHAER	2014/01/24	TEN60 RECEIPT ASSY POWER/SIGNAL MIXED PANEL-TO-BOARD	
			CHECKED BY	DATE	molex	
			APPROVED BY	DATE	SD-172512-001	
			BPISZCZOR	2016/10/03	SHEET NO. 1 OF 1	
			MATERIAL NO.	DOCUMENT NO.	THIS DRAWING CONTAINS INFORMATION THAT IS PROPRIETARY TO MOLEX INCORPORATED AND SHOULD NOT BE USED WITHOUT WRITTEN PERMISSION	
			SEE CHART	SD-172512-001		

CKT SIZE	① HOUSING	② TPA	③ POWER TERMINAL	④ SIGNAL TERMINAL	⑤ SIGNAL HOUSING (3 OF EA REQ'D)	DIMENSION 'A'	DIMENSION 'B'	DIMENSION 'C'	DIMENSION 'D'	DIMENSION 'E'
	MATERIAL: PBT, FILLED	MATERIAL: PBT, FILLED	MATERIAL: COPPER ALLOY FINISH: TIN OVER NICKEL W/SELECT GOLD	MATERIAL: PHOS. BRONZE FINISH: TIN OVER NICKEL W/SELECT GOLD	MATERIAL: NYLON, UNFILLED					
2P-12S	172512-3212	46708-3212	173693-****	70058-****	46709-0004	63.81	55.01	26.48	12.37	43.74
2P-18S	172512-3218	46708-3218	173693-****	70058-****	46709-0006	68.89	60.09	31.80	17.44	48.82
2P-24S	172512-3224	46708-3224	173693-****	70058-****	46709-0008	73.97	65.17	36.85	22.53	53.90
4P-12S	172512-3412	46708-3412	173693-****	70058-****	46709-0004	78.81	70.01	41.48	12.37	58.74
4P-18S	172512-3418	46708-3418	173693-****	70058-****	46709-0006	83.89	75.09	46.80	17.44	63.82
4P-24S	172512-3424	46708-3424	173693-****	70058-****	46709-0008	88.97	80.17	51.85	22.53	68.90
6P-12S	172512-3612	46708-3612	173693-****	70058-****	46709-0004	93.81	85.01	55.73	12.37	73.74
6P-18S	172512-3618	46708-3618	173693-****	70058-****	46709-0006	98.89	90.09	61.85	17.44	78.82
6P-24S	172512-3624	46708-3624	173693-****	70058-****	46709-0008	103.97	95.17	66.93	22.53	83.90

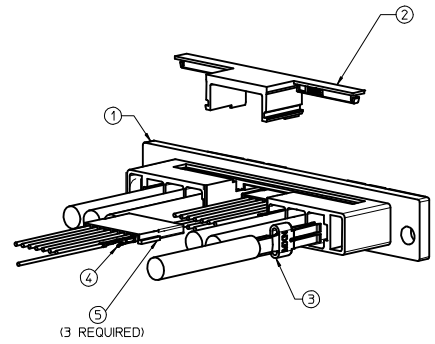

EXPLODED VIEW

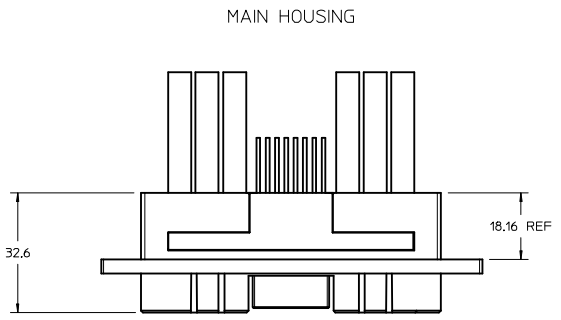

MAIN HOUSING

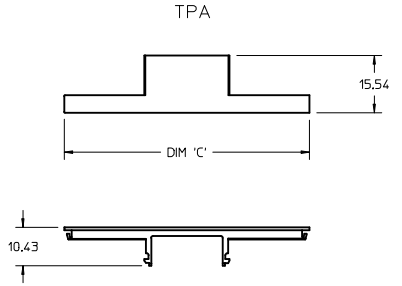

TPA

SIGNAL HOUSING

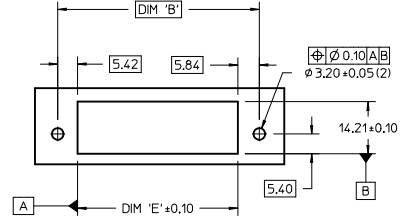
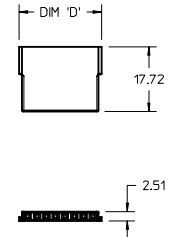

PANEL CUTOUT
(FRONT VIEW)

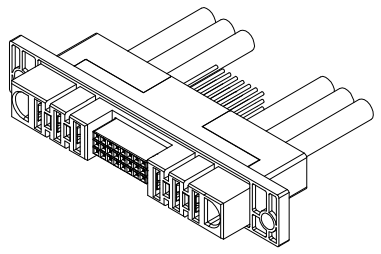
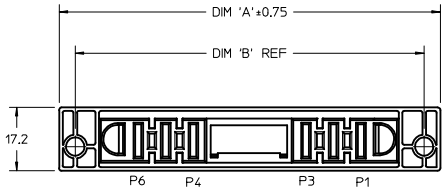

- NOTES:
- SEE CHART FOR MATERIAL DETAILS
 - PART MATES TO MOLEX PLUG SERIES 172458.
 - ASSEMBLY SHOWN FOR REFERENCE ONLY. EACH ITEM HAS TO BE ORDERED SEPARATELY.
 - PANEL MOUNTING HARDWARE: (2) M3 X 0.5 X 4.00 LG PRECISION SHOULDER SCREWS AND (2) M3 X 0.5 HEX NUTS TO BE PURCHASED SEPARATELY BY CUSTOMER.
 - SEE SD-173693-001 FOR POWER TERMINAL DETAILS.
 - SEE SD-70058-*** FOR SIGNAL TERMINAL DETAILS.

CHG TRMNL P/N EC NO: UCP2016-4071 DRAWN: JSCHAER 2016/04/18 CHKD: APPR: BPISZCZOR 2016/10/03	QUALITY SYMBOLS	GENERAL TOLERANCES (UNLESS SPECIFIED)	DIMENSION STYLE	SCALE	DESIGN UNITS	THIRD ANGLE PROJECTION																		
	$\nabla=0$ $\nabla=0$ $\nabla=0$	<table border="1"> <thead> <tr> <th></th> <th>mm</th> <th>INCH</th> </tr> </thead> <tbody> <tr> <td>4 PLACES</td> <td>±---</td> <td>±---</td> </tr> <tr> <td>3 PLACES</td> <td>±---</td> <td>±---</td> </tr> <tr> <td>2 PLACES</td> <td>±0.13</td> <td>±---</td> </tr> <tr> <td>1 PLACE</td> <td>±0.25</td> <td>±---</td> </tr> <tr> <td>0 PLACE</td> <td>±---</td> <td>±---</td> </tr> </tbody> </table>		mm	INCH	4 PLACES	±---	±---	3 PLACES	±---	±---	2 PLACES	±0.13	±---	1 PLACE	±0.25	±---	0 PLACE	±---	±---	MM ONLY	1.5:1	METRIC	
		mm	INCH																					
	4 PLACES	±---	±---																					
3 PLACES	±---	±---																						
2 PLACES	±0.13	±---																						
1 PLACE	±0.25	±---																						
0 PLACE	±---	±---																						
DESCRIPTION	APPROVED BY	DATE	TITLE	TEN60 RECEIPT ASSY POWER/SIGNAL MIXED PANEL-TO-BOARD																				
	BPISZCZOR	2016/10/03	SEE CHART																					
	DRAFT WHERE APPLICABLE MUST REMAIN WITHIN DIMENSIONS		MATERIAL NO.		DOCUMENT NO.	SHEET NO.																		
			SD-172512-001		1 OF 1																			
THIS DRAWING CONTAINS INFORMATION THAT IS PROPRIETARY TO MOLEX INCORPORATED AND SHOULD NOT BE USED WITHOUT WRITTEN PERMISSION																								