

GloTek, Inc. www.globtek.com 186 Veterans Drive, Northvale, NJ 07647 Tel. (201) 784-1000 Fax (201) 784-0111	Drawing Title: GT-83084-0806-0.8-USB-W2IN, ICT/ITE Power Supply, Efficiency Level: USA DOE Level VI / Eco-design Directive 2009/125/EC, (EU) 2019/1782, Case Color/Style: GloTek Black, Wall Plug-in, AC/DC Switching Adapter with USB Power Supply AC Adaptor, Input Rating: 100-240V- , 50/60Hz, India Fixed , Output Rating: 7.8W, 5.2V@1.5A, Output Configuration: N/A mm, N/A/4 Cond, N/A, Type "A" USB "JACK", integral to power supply enclosure, Ferrite: None, N/A, GT Cord # C0132, Pin Out: Pin 1:(+), Pin 2 (D-): Connected to Pin 3 (D+), Pin 3 (D+): Connected to Pin 2 (D-), Pin 4:(-); P2 (D-) and P3 (D+) are shorted together inside power supply., Blades/Input Cord: Fixed Blades India 2 Conductor, Approvals: RoHS; CE; China RoHS; Double Insulation; EAC; Level VI; WEEE; SIQ; CB 60950; India; CB 62368; LPS 62368;	
	Model No. GT-83084-0806-0.8-USB-W2IN	
	Part No./Ordering No. WR9WA1500U53INF(R6B)	Rev A1

In Addition to GloTek Inc.'s renewed ISO9001:2015 - Quality Management System Certification, GloTek Inc. is now certified to:

ISO13485:2016 - Medical Devices Quality Management System Certification

ISO14001:2015 - Environmental Management System Certification

ISO Certificates are available online at <https://www.globtek.com/iso-certificates/>

The acceptance of this specification and use of the product described in this document indicates the acceptance and binding of the customer to GloTek TERMS AND CONDITIONS (attached to the end of this document), which supersede all other agreements, terms, and conditions (<https://en.globtek.com/terms-and-conditions/>).

The purchaser of this product (Customer) agrees that it is their sole responsibility to determine suitability/fitness of the product described in this specification for their application and to take precautions for protection against any hazards attendant to the handling and use of the product.

Footnote:

GloTek Inc. will not be liable for the safety and performance of these power supplies/battery packs if unauthorized access and repair occurs. End user should consult applicable UL, CSA or EN standards for proper installation instruction.

Limitation of Use:

GloTek products are intended for use with commercial, medical, and/or industrial equipment only. GloTek product are not authorized for use as mission critical components in life support hazardous environment, nuclear or aircraft applications without prior written approval from the CEO of GloTek Inc.

Contents of this document are subject to change without prior notice.

### Customer Approval of Specification:

Please approve, sign and send back to GloTek so we can complete order processing.

A delay in receipt of this form will delay delivery schedule.

Company Name: _____	Customer P/N: _____
Quote Number: _____	Date: _____
Authorized Representative Name: _____	Authorized Representative Signature: _____

GloTek, Inc. www.globtek.com 186 Veterans Drive, Northvale, NJ 07647 Tel. (201) 784-1000 Fax (201) 784-0111	Drawing Title: GT-83084-0806-0.8-USB-W2IN, ICT/ITE Power Supply, Efficiency Level: USA DOE Level VI / Eco-design Directive 2009/125/EC, (EU) 2019/1782, Case Color/Style: GlobTek Black, Wall Plug-in, AC/DC Switching Adapter with USB Power Supply AC Adaptor, Input Rating: 100-240V- , 50/60Hz, India Fixed , Output Rating: 7.8W, 5.2V@1.5A, Output Configuration: N/A mm, N/A/4 Cond, N/A, Type "A" USB "JACK", integral to power supply enclosure, Ferrite: None, N/A, GT Cord # C0132, Pin Out: Pin 1:(+), Pin 2 (D-): Connected to Pin 3 (D+), Pin 3 (D+): Connected to Pin 2 (D-), Pin 4:(-); P2 (D-) and P3 (D+) are shorted together inside power supply., Blades/Input Cord: Fixed Blades India 2 Conductor, Approvals: RoHS; CE; China RoHS; Double Insulation; EAC; Level VI; WEEE; SIQ; CB 60950; India; CB 62368; LPS 62368;	
	Model No. GT-83084-0806-0.8-USB-W2IN	
	Part No./Ordering No. WR9WA1500U53INF(R6B)	Rev A1

## REVISION HISTORY

REV	DESCRIPTION	SUB	DATE	APPROVED
A1	Add label to deviation	QA	01/20/2022	QA
A	initial release	krakoM	12/06/2019	QA

### POWER SUPPLY INFORMATION

TYPE	Wall Plug-in
TECHNOLOGY	AC/DC Switching Adapter with USB Power Supply AC Adaptor
CASE COLOR	GlobTek Black
NAMEPLATE RATED INPUT	100-240V- , 50/60Hz, 0.3A
INPUT CONFIG	India Fixed
WATTS	7.80
VOLTS OUT	5.2
CURRENT OUT (Amps)	1.5
BLADE/CORD INCLUDED	FBIndia2 Fixed Blades India 2 Conductor
BLADE/CORD INSTALLED	FBIndia2 :Fixed Blades India 2 Conductor
INGRESS PROTECTION	
GROUNDING CONFIGURATION	(F1) Class II / Double Insulated
EFFICIENCY LEVEL	USA DOE Level VI / Eco-design Directive 2009/125/EC, (EU) 2019/1782
OUTPUT CONFIGURATION	N/A mm, N/A/4 Cond, N/A, Type "A" USB "JACK", integral to power supply enclosure, Ferrite: None, N/A, GT Cord # C0132
CONNECTOR PIN OUT	Pin 1:(+), Pin 2 (D-): Connected to Pin 3 (D+), Pin 3 (D+): Connected to Pin 2 (D-), Pin 4:(-); P2 (D-) and P3 (D+) are shorted together inside power supply.
LABEL SPECS	Standard GT - See Deviations,L-1604
SPECIAL BARCODE LABEL MATERIAL	No
PACK SPEC	
USER MANUAL	

#### PROPRIETARY INFORMATION

GloTek, Inc. www.globtek.com 186 Veterans Drive, Northvale, NJ 07647 Tel. (201) 784-1000 Fax (201) 784-0111	Drawing Title: GT-83084-0806-0.8-USB-W2IN, ICT/ITE Power Supply, Efficiency Level: USA DOE Level VI / Eco-design Directive 2009/125/EC, (EU) 2019/1782, Case Color/Style: GloTek Black, Wall Plug-in, AC/DC Switching Adapter with USB Power Supply AC Adaptor, Input Rating: 100-240V~, 50/60Hz, India Fixed, Output Rating: 7.8W, 5.2V@1.5A, Output Configuration: N/A mm, N/A/4 Cond, N/A, Type "A" USB "JACK", integral to power supply enclosure, Ferrite: None, N/A, GT Cord # C0132, Pin Out: Pin 1:(+), Pin 2 (D-): Connected to Pin 3 (D+), Pin 3 (D+): Connected to Pin 2 (D-), Pin 4:(-); P2 (D-) and P3 (D+) are shorted together inside power supply., Blades/Input Cord: Fixed Blades India 2 Conductor, Approvals: RoHS; CE; China RoHS; Double Insulation; EAC; Level VI; WEEE; SIQ; CB 60950; India; CB 62368; LPS 62368;	
	Model No. GT-83084-0806-0.8-USB-W2IN	
	Part No./Ordering No. WR9WA1500U53INF(R6B)	Rev A1

Notes/Modifications/Customizations (notes in this section supersede the values shown in the standard spec)

DIMENSIONS ARE IN MM UNLESS SPECIFIED OTHERWISE



**Build Per RFP RFI-793492**

2) Label to be marked with 5.2V rating (power supply is set to 5.3V, within allowable tolerance of 5.2V label rating).

Specified output rating: 5.2V -3%/+5% (see table below):

Parameter	Min	Typical	Max	Units
Input Voltage	100	-	240	VAC
Input Frequency	50	-	60	Hz
Output Voltage	5.00	5.30	5.46	VDC
Output Current	1.5	-	-	Amps
Output Power (for reference only)	7.5			Watts

3) Label may not be revised without customer approval.

4) Label QR code naming rule:

I + WWYY+ 00000001—99999999 (13 letters in total)

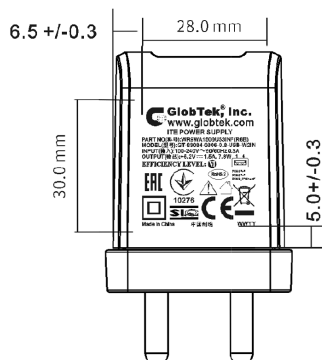

GlobTek, Inc. www.globtek.com 186 Veterans Drive, Northvale, NJ 07647 Tel. (201) 784-1000 Fax (201) 784-0111	Drawing Title: GT-83084-0806-0.8-USB-W2IN, ICT/ITE Power Supply, Efficiency Level: USA DOE Level VI / Eco-design Directive 2009/125/EC, (EU) 2019/1782, Case Color/Style: GlobTek Black, Wall Plug-in, AC/DC Switching Adapter with USB Power Supply AC Adaptor, Input Rating: 100-240V- , 50/60Hz, India Fixed , Output Rating: 7.8W, 5.2V@1.5A, Output Configuration: N/A mm, N/A/4 Cond, N/A, Type "A" USB "JACK", integral to power supply enclosure, Ferrite: None, N/A, GT Cord # C0132, Pin Out: Pin 1:(+), Pin 2 (D-): Connected to Pin 3 (D+), Pin 3 (D+): Connected to Pin 2 (D-), Pin 4:(-); P2 (D-) and P3 (D+) are shorted together inside power supply., Blades/Input Cord: Fixed Blades India 2 Conductor, Approvals: RoHS; CE; China RoHS; Double Insulation; EAC; Level VI; WEEE; SIQ; CB 60950; India; CB 62368; LPS 62368;	
	Model No. GT-83084-0806-0.8-USB-W2IN	
	Part No./Ordering No. WR9WA1500U53INF(R6B)	Rev A1

## ELECTRICAL SPECIFICATIONS

01. Input Voltage: Specified 90-264 Vac, Nameplate rated: 100-240Vac
02. Input Frequency: Specified 47-63 Hz, Nameplate rated 50-60Hz
03. Output Regulation: +/- 5% measured at the end of a 0.6 meter USB cordset employing #22 Gauge conductors
04. Line Voltage Regulation: +/- 1% typical measured at the end of a 0.6 meter USB cordset employing #22 Gauge conductors
05. Output Ripple (Vp-p): +/-1% or 100 mV whichever is greater measured at the end of a 0.6 meter USB cordset employing #22 Gauge conductors. Measured at 20 MHz bandwidth with 0.1 uf ceramic capacitor in parallel with 10 uf electrolytic capacitor connected at the end of the output connector.
06. Hold-up Time: 5 mS minimum
07. Inrush Current: at full load, 25°C, cold start
08. Efficiency: 79% minimum, Meet standard for energy star level: VI, ERP :2009/125/EC

### B) PROTECTION

01. Over-current protection: 4A maximum with auto-recovery function
02. Over-voltage protection: 10VDC maximum with zener clamp
03. Short-circuit protection: The adapter shall not be damaged by short the DC output to Ground.

### C) SAFETY

01. Dielectric Withstand Voltage: Primary To Secondary: 3000VAC 10mA 1minute or 4242VDC 10mA 1minute
02. Leakage Current: 25mA maximum, at nominal AC input voltage and frequency
03. ESD Immunity per EN61000-4-2, ±8 kV contact, ±15 kV air, Perf Criteria A Standard.

### D) EMC

01. Emissions, per EN 55032, EN 61000-6-3, EN 61000-6-4
  - Conducted Emissions: Class B, FCC Part 15, Class B
  - Radiated Emissions: Class B, FCC Part 15, Class B
02. Line Frequency Harmonics EN61000-3-2, Class A
03. Voltage Fluctuations/Flicker EN61000-3-3
04. Immunity, per EN 55024, EN 61000-6-1, EN 61000-6-2
  - Static Discharge Immunity EN61000-4-2, 4kV Contact Discharge, 8kV air discharge
  - Radiated RF Immunity EN61000-4-3, 3V/m 80-1000MHz, 80% 1KHz AM.
  - EFT/Burst Immunity EN61000-4-4, 1kV/100kHz.
  - Line Surge Immunity EN61000-4-5, 1kV differential, 2kV common-mode
  - Conducted RF Immunity EN61000-4-6, 3Vrms, 80% 1KHz AM
  - Power Frequency Magnetic Field Immunity EN61000-4-8, 1A/m
  - Voltage Dip Immunity EN61000-4-11, Criteria

### E) OTHER:

01. MTBF: 200,000 Hours @ 25°C ambient temperature
02. Operating Temperature: -10°C to 50°C ambient temperature
03. Operating Humidity: 20 ~ 85 % RH. non-condensing
05. Storage Temperature: -20°C to 60°C
06. Storage Humidity: 5 ~ 95 % RH. non-condensing
07. Cooling: Cooling shall be with natural convection cooling
08. RoHS 2: Complies with EU 2011/65/EU China SJ/T 11364-2014

## PROPRIETARY INFORMATION

PROPRIETARY OF GLOBTEK, INC. ANY REPRODUCTION, DISCLOSURE OR USE OF THIS DRAWING, IN WHOLE OR IN PART, IS HEREBY PROHIBITED EXCEPT AS SPECIFIED IN

WRITING BY GLOBTEK, INC. © GlobTek, Inc. 2019 - 2023

quest / 05/17/2023 10:01:23 AM GMT CLONED FROM WR9WA1500U53INF(R6W)

GlobTek, Inc. www.globtek.com 186 Veterans Drive, Northvale, NJ 07647 Tel. (201) 784-1000 Fax (201) 784-0111	Drawing Title: GT-83084-0806-0.8-USB-W2IN, ICT/ITE Power Supply, Efficiency Level: USA DOE Level VI / Eco-design Directive 2009/125/EC, (EU) 2019/1782, Case Color/Style: GlobTek Black, Wall Plug-in, AC/DC Switching Adapter with USB Power Supply AC Adaptor, Input Rating: 100-240V- , 50/60Hz, India Fixed , Output Rating: 7.8W, 5.2V@1.5A, Output Configuration: N/A mm, N/A/4 Cond, N/A, Type "A" USB "JACK", integral to power supply enclosure, Ferrite: None, N/A, GT Cord # C0132, Pin Out: Pin 1:(+), Pin 2 (D-): Connected to Pin 3 (D+), Pin 3 (D+): Connected to Pin 2 (D-), Pin 4:(-); P2 (D-) and P3 (D+) are shorted together inside power supply., Blades/Input Cord: Fixed Blades India 2 Conductor, Approvals: RoHS; CE; China RoHS; Double Insulation; EAC; Level VI; WEEE; SIQ; CB 60950; India; CB 62368; LPS 62368;	
	Model No. GT-83084-0806-0.8-USB-W2IN	
	Part No./Ordering No. WR9WA1500U53INF(R6B)	Rev A1

F) ENCLOSURE

- 01. Housing: High impact plastic, 94V0 polycarbonate, non-vented
- 02. Markings: Label and/or Pad Printed and/or Molded in the case

TO ADDRESS SYSTEM-LEVEL EMI CONCERNS, FERRITE CHOKES/BEADS MAY BE ADDED/REVISED UPON REQUEST. A SAMPLE KIT OF GLOBTEK'S STANDARD FERRITES IS AVAILABLE UNDER GLOBTEK P/N: EMI-MITIGATION-KIT1

FOR ADDITIONAL INFORMATION, PLEASE READ OUR WHITE PAPER AT:

<https://en.globtek.com/technical-articles/ferrite-kit-radiated-emi-suppression-kit-for-globtek-power-supplies-cable-assemblies>

<p>GlobTek, Inc.  www.globtek.com  186 Veterans Drive,  Northvale, NJ 07647  Tel. (201) 784-1000  Fax (201) 784-0111</p>	<p>Drawing Title: GT-83084-0806-0.8-USB-W2IN, ICT/ITE Power Supply, Efficiency Level: USA DOE Level VI / Eco-design Directive 2009/125/EC, (EU) 2019/1782, Case Color/Style: GlobTek Black, Wall Plug-in, AC/DC Switching Adapter with USB Power Supply AC Adaptor, Input Rating: 100-240V- , 50/60Hz, India Fixed , Output Rating: 7.8W, 5.2V@1.5A, Output Configuration: N/A mm, N/A/4 Cond, N/A, Type "A" USB "JACK", integral to power supply enclosure, Ferrite: None, N/A, GT Cord # C0132, Pin Out: Pin 1:(+), Pin 2 (D-): Connected to Pin 3 (D+), Pin 3 (D+): Connected to Pin 2 (D-), Pin 4:(-); P2 (D-) and P3 (D+) are shorted together inside power supply., Blades/Input Cord: Fixed Blades India 2 Conductor, Approvals: RoHS; CE; China RoHS; Double Insulation; EAC; Level VI; WEEE; SIQ; CB 60950; India; CB 62368; LPS 62368;</p>	
	<p>Model No. GT-83084-0806-0.8-USB-W2IN</p>	
	<p>Part No./Ordering No. WR9WA1500U53INF(R6B)</p>	<p>Rev A1</p>

3D File Download [https://www.globtek.com/dl/gt-83084-wwwv-usb-w2in\\_asm\\_asm\\_asm.igs](https://www.globtek.com/dl/gt-83084-wwwv-usb-w2in_asm_asm_asm.igs)

Mechanical drawing

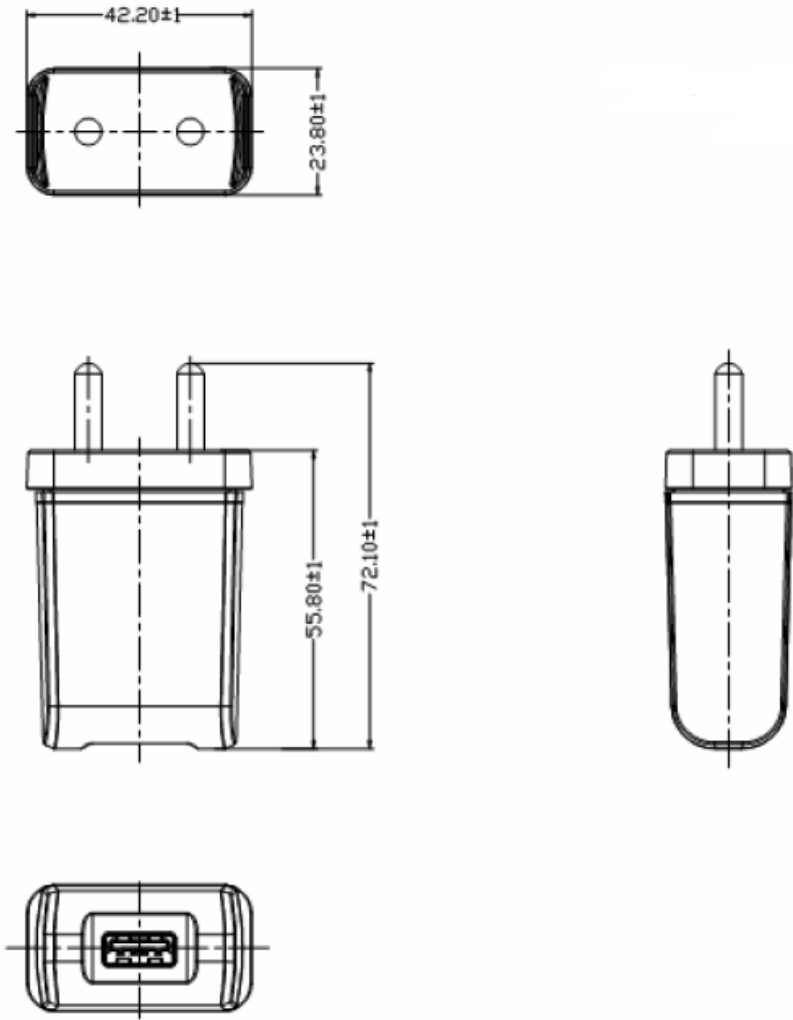

<p>GlobTek, Inc.  www.globtek.com  186 Veterans Drive,  Northvale, NJ 07647  Tel. (201) 784-1000  Fax (201) 784-0111</p>	<p>Drawing Title: GT-83084-0806-0.8-USB-W2IN, ICT/ITE Power Supply, Efficiency Level: USA DOE Level VI / Eco-design Directive 2009/125/EC, (EU) 2019/1782, Case Color/Style: GlobTek Black, Wall Plug-in, AC/DC Switching Adapter with USB Power Supply AC Adaptor, Input Rating: 100-240V- , 50/60Hz, India Fixed , Output Rating: 7.8W, 5.2V@1.5A, Output Configuration: N/A mm, N/A/4 Cond, N/A, Type "A" USB "JACK", integral to power supply enclosure, Ferrite: None, N/A, GT Cord # C0132, Pin Out: Pin 1:(+), Pin 2 (D-): Connected to Pin 3 (D+), Pin 3 (D+): Connected to Pin 2 (D-), Pin 4:(-); P2 (D-) and P3 (D+) are shorted together inside power supply., Blades/Input Cord: Fixed Blades India 2 Conductor, Approvals: RoHS; CE; China RoHS; Double Insulation; EAC; Level VI; WEEE; SIQ; CB 60950; India; CB 62368; LPS 62368;</p>	
	<p>Model No. GT-83084-0806-0.8-USB-W2IN</p>	
	<p>Part No./Ordering No. WR9WA1500U53INF(R6B)</p>	<p>Rev A1</p>

DERATING CURVE

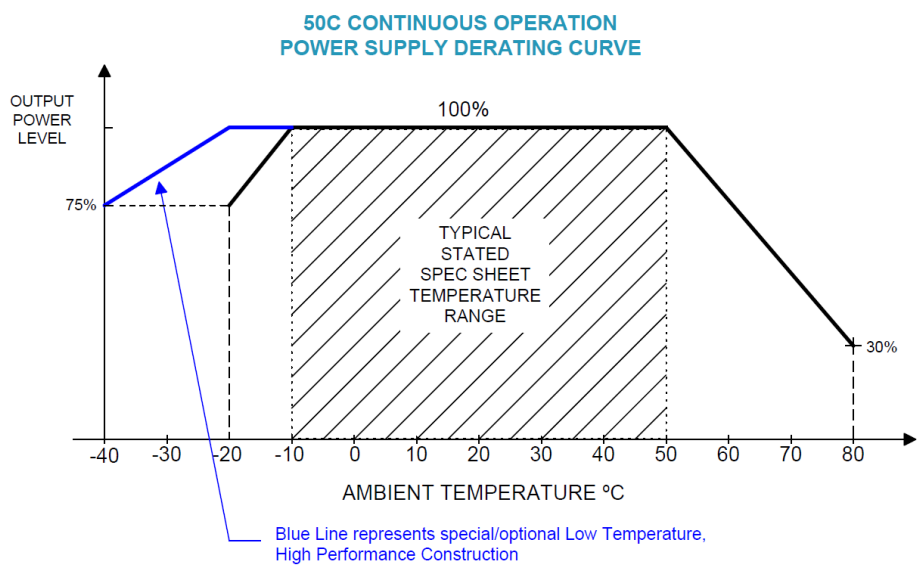

<p>GlobTek, Inc.  www.globtek.com  186 Veterans Drive,  Northvale, NJ 07647  Tel. (201) 784-1000  Fax (201) 784-0111</p>	Drawing Title: GT-83084-0806-0.8-USB-W2IN, ICT/ITE Power Supply, Efficiency Level: USA DOE Level VI / Eco-design Directive 2009/125/EC, (EU) 2019/1782, Case Color/Style: GlobTek Black, Wall Plug-in, AC/DC Switching Adapter with USB Power Supply AC Adaptor, Input Rating: 100-240V- , 50/60Hz, India Fixed , Output Rating: 7.8W, 5.2V@1.5A, Output Configuration: N/A mm, N/A/4 Cond, N/A, Type "A" USB "JACK", integral to power supply enclosure, Ferrite: None, N/A, GT Cord # C0132, Pin Out: Pin 1:(+), Pin 2 (D-): Connected to Pin 3 (D+), Pin 3 (D+): Connected to Pin 2 (D-), Pin 4:(-); P2 (D-) and P3 (D+) are shorted together inside power supply., Blades/Input Cord: Fixed Blades India 2 Conductor, Approvals: RoHS; CE; China RoHS; Double Insulation; EAC; Level VI; WEEE; SIQ; CB 60950; India; CB 62368; LPS 62368;	
	Model No. GT-83084-0806-0.8-USB-W2IN	
	Part No./Ordering No. WR9WA1500U53INF(R6B)	Rev A1

**INPUT CONFIGURATION**

(F1) Class II / Double Insulated

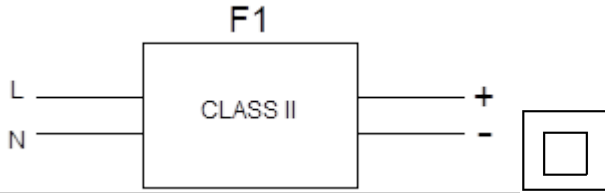

[Alternate grounding configurations](#) available upon request.

Blades/Cord Included:FBIndia2:Fixed Blades India 2 Conductor

Blades/Cord Installed:FBIndia2:Fixed Blades India 2 Conductor

IS 1293 India, 2 Blade Ground Class II

- Class II plugs are rated at 2.5 and 6 amps



GlobTek, Inc. www.globtek.com 186 Veterans Drive, Northvale, NJ 07647 Tel. (201) 784-1000 Fax (201) 784-0111	Drawing Title: GT-83084-0806-0.8-USB-W2IN, ICT/ITE Power Supply, Efficiency Level: USA DOE Level VI / Eco-design Directive 2009/125/EC, (EU) 2019/1782, Case Color/Style: GlobTek Black, Wall Plug-in, AC/DC Switching Adapter with USB Power Supply AC Adaptor, Input Rating: 100-240V- , 50/60Hz, India Fixed , Output Rating: 7.8W, 5.2V@1.5A, Output Configuration: N/A mm, N/A/4 Cond, N/A, Type "A" USB "JACK", integral to power supply enclosure, Ferrite: None, N/A, GT Cord # C0132, Pin Out: Pin 1:(+), Pin 2 (D-): Connected to Pin 3 (D+), Pin 3 (D+): Connected to Pin 2 (D-), Pin 4:(-); P2 (D-) and P3 (D+) are shorted together inside power supply., Blades/Input Cord: Fixed Blades India 2 Conductor, Approvals: RoHS; CE; China RoHS; Double Insulation; EAC; Level VI; WEEE; SIQ; CB 60950; India; CB 62368; LPS 62368;	
	Model No. GT-83084-0806-0.8-USB-W2IN	
	Part No./Ordering No. WR9WA1500U53INF(R6B)	Rev A1

**OUTPUT CORD AND CONNECTOR: USBMT/C0132**

ACTUAL CONNECTORS, OVERMOLDS, FERRITES MAY VARY SLIGHTLY FROM THE PICTURE BELOW

CABLE TYPE	N/A
CABLE LENGTH (mm)	N/A
CABLE TOLERANCE (mm)	N/A
WIRE GAUGE (AWG)	N/A
CONDUCTORS	4
HANK DIMENSION (mm)	N/A
CABLE / CONNECTOR OVERMOLD COLOR	N/A
FERRITE TYPE AND DIMENSION	None
FERRITE NUMBER OF TURNS(Definition)	N/A
FERRITE DIMENSION FROM STRAIN RELIEF	N/A
FERRITE DIMENSION FROM PLUG	N/A
PLUG TYPE	Type "A" USB "JACK", integral to power supply enclosure
OVER MOLD ORIENTATION	PCB Mount Connector
CONNECTOR PIN OUT	Pin 1:(+), Pin 2 (D-): Connected to Pin 3 (D+), Pin 3 (D+): Connected to Pin 2 (D-), Pin 4:(-); P2 (D-) and P3 (D+) are shorted together inside power supply.

**ADDITIONAL REQUIREMENTS**

Front View

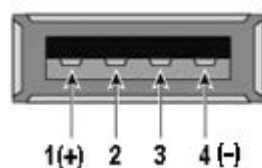

ADDITIONAL OUTPUT PLUG OPTIONS ARE AVAILABLE AT <https://www.globtek.com/connectors/>  
STANDARD PLUGS AND CONNECTORS CAN BE SEEN ONLINE AT <https://www.globtek.com/connectors/>  
CALCULATE VOLTAGE REGULATION/DROP WITH OUR ONLINE CALCULATOR: <https://en.globtek.com/output-cable-regulation-calculator/>

<p>GlobTek, Inc. www.globtek.com 186 Veterans Drive, Northvale, NJ 07647 Tel. (201) 784-1000 Fax (201) 784-0111</p>	<p>Drawing Title: GT-83084-0806-0.8-USB-W2IN, ICT/ITE Power Supply, Efficiency Level: USA DOE Level VI / Eco-design Directive 2009/125/EC, (EU) 2019/1782, Case Color/Style: GlobTek Black, Wall Plug-in, AC/DC Switching Adapter with USB Power Supply AC Adaptor, Input Rating: 100-240V- , 50/60Hz, India Fixed , Output Rating: 7.8W, 5.2V@1.5A, Output Configuration: N/A mm, N/A/4 Cond, N/A, Type "A" USB "JACK", integral to power supply enclosure, Ferrite: None, N/A, GT Cord # C0132, Pin Out: Pin 1:(+), Pin 2 (D-): Connected to Pin 3 (D+), Pin 3 (D+): Connected to Pin 2 (D-), Pin 4:(-); P2 (D-) and P3 (D+) are shorted together inside power supply., Blades/Input Cord: Fixed Blades India 2 Conductor, Approvals: RoHS; CE; China RoHS; Double Insulation; EAC; Level VI; WEEE; SIQ; CB 60950; India; CB 62368; LPS 62368;</p>
	<p>Model No. GT-83084-0806-0.8-USB-W2IN</p>
	<p>Part No./Ordering No. WR9WA1500U53INF(R6B) <span style="float: right;">Rev A1</span></p>

## OUTPUT CONNECTOR HOOK UP

TO ADDRESS SYSTEM-LEVEL EMI CONCERNS, FERRITE CHOKES/BEADS MAY BE ADDED/REVISED UPON REQUEST. A SAMPLE KIT OF GLOBTEK'S STANDARD FERRITES IS AVAILABLE UNDER GLOBTEK P/N: EMI-MITIGATION-KIT1

FOR ADDITIONAL INFORMATION, PLEASE READ OUR WHITE PAPER AT:

<https://en.globtek.com/technical-articles/ferrite-kit-radiated-emi-suppression-kit-for-globtek-power-supplies-cable-assemblies>

GlobTek, Inc. www.globtek.com 186 Veterans Drive, Northvale, NJ 07647 Tel. (201) 784-1000 Fax (201) 784-0111	Drawing Title: GT-83084-0806-0.8-USB-W2IN, ICT/ITE Power Supply, Efficiency Level: USA DOE Level VI / Eco-design Directive 2009/125/EC, (EU) 2019/1782, Case Color/Style: GlobTek Black, Wall Plug-in, AC/DC Switching Adapter with USB Power Supply AC Adaptor, Input Rating: 100-240V- , 50/60Hz, India Fixed , Output Rating: 7.8W, 5.2V@1.5A, Output Configuration: N/A mm, N/A/4 Cond, N/A, Type "A" USB "JACK", integral to power supply enclosure, Ferrite: None, N/A, GT Cord # C0132, Pin Out: Pin 1:(+), Pin 2 (D-): Connected to Pin 3 (D+), Pin 3 (D+): Connected to Pin 2 (D-), Pin 4:(-); P2 (D-) and P3 (D+) are shorted together inside power supply., Blades/Input Cord: Fixed Blades India 2 Conductor, Approvals: RoHS; CE; China RoHS; Double Insulation; EAC; Level VI; WEEE; SIQ; CB 60950; India; CB 62368; LPS 62368;	
	Model No. GT-83084-0806-0.8-USB-W2IN	
	Part No./Ordering No. WR9WA1500U53INF(R6B)	Rev A1

LABEL:L-1604

LABEL P/N	Standard GT - See Deviations
MATERIAL	Flat Thermal Transfer, Imprintable, Polyester Label and/or Pad Printed and/or Molded, and/or Laser Engraved in the case
BACKGROUND COLOR	Black if housing is Black, White or Silver if housing is White or Gray.
TEXT COLOR	White or Silver if label is Black Background for Black housing. Black if label is White or Silver background and Housing is White or Gray.
LABEL WIDTH (mm)	28.0
LABEL HEIGHT (mm)	30.0
SPECIAL BARCODE LABEL MATERIAL	No

Below is the minimum information which will appear on the label. NOTE: in the logo area additional/actual positioning of symbols and text is subjected to change as per agency updates/requirements or additional model approvals become available. Regulatory certifications/label markings may be in logo area on the label or molded into the case housing outside the label area. Information will be shown via label and/or pad printed and/or molded and/or laser engraved in the case. \* Date code markings at GlobTek option.



Please refer to the deviations section of the product specifications for additional details regarding the label.

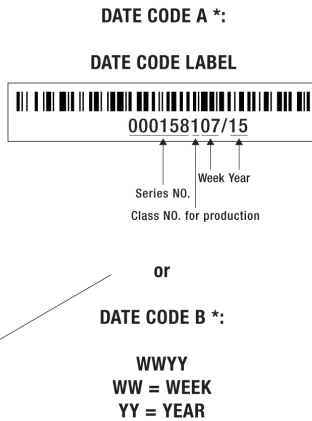
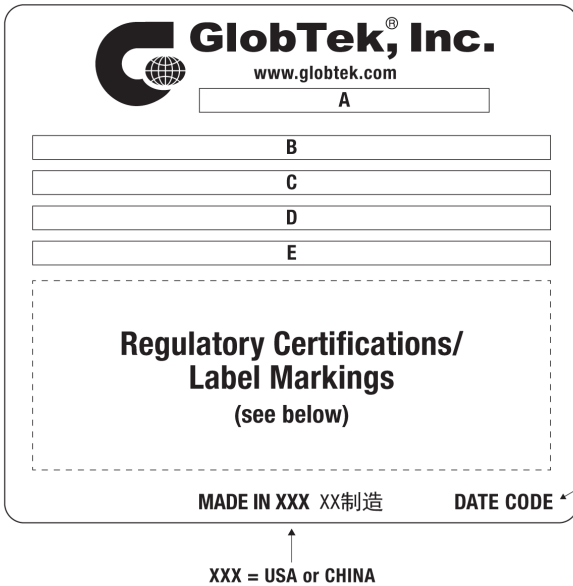

- A=ICT/ITE Power Supply
- B=P/N: (料号) WR9WA1500U53INF(R6B)
- C=Model (型号) GT-83084-0806-0.8-USB-W2IN
- D=Input (输入)100-240V- , 50/60Hz, 0.3A
- E=Output (输出)5.2 V 1.5 A, 7.80W

GlobTek, Inc. www.globtek.com 186 Veterans Drive, Northvale, NJ 07647 Tel. (201) 784-1000 Fax (201) 784-0111	Drawing Title: GT-83084-0806-0.8-USB-W2IN, ICT/ITE Power Supply, Efficiency Level: USA DOE Level VI / Eco-design Directive 2009/125/EC, (EU) 2019/1782, Case Color/Style: GlobTek Black, Wall Plug-in, AC/DC Switching Adapter with USB Power Supply AC Adaptor, Input Rating: 100-240V- , 50/60Hz, India Fixed , Output Rating: 7.8W, 5.2V@1.5A, Output Configuration: N/A mm, N/A/4 Cond, N/A, Type "A" USB "JACK", integral to power supply enclosure, Ferrite: None, N/A, GT Cord # C0132, Pin Out: Pin 1:(+), Pin 2 (D-): Connected to Pin 3 (D+), Pin 3 (D+): Connected to Pin 2 (D-), Pin 4:(-); P2 (D-) and P3 (D+) are shorted together inside power supply., Blades/Input Cord: Fixed Blades India 2 Conductor, Approvals: RoHS; CE; China RoHS; Double Insulation; EAC; Level VI; WEEE; SIQ; CB 60950; India; CB 62368; LPS 62368;	
	Model No. GT-83084-0806-0.8-USB-W2IN	
	Part No./Ordering No. WR9WA1500U53INF(R6B)	Rev A1

AGENCY ONLINE DOCUMENTS	<a href="http://www.globtek.info/certs/GT-83084-USB-W2Z/">http://www.globtek.info/certs/GT-83084-USB-W2Z/</a>
CE EC-Declaration for Medical	<a href="#">Contact GlobTek for more information</a>
CE EC-Declaration for Industrial/Commercial/ITE	<a href="http://globtek.force.com/models/ec_declaration_product?id=01t3a000004eNhl&amp;i=2">http://globtek.force.com/models/ec_declaration_product?id=01t3a000004eNhl&amp;i=2</a>
CE EC-Declaration for Household	<a href="#">Contact GlobTek for more information</a>
UKCA-Declaration for Medical	<a href="#">Contact GlobTek for more information</a>
UKCA-Declaration for Industrial/Commercial/ITE	<a href="http://globtek.force.com/models/ukca_declaration_product?id=01t3a000004eNhl&amp;i=2">http://globtek.force.com/models/ukca_declaration_product?id=01t3a000004eNhl&amp;i=2</a>
UKCA-Declaration for Household	<a href="#">Contact GlobTek for more information</a>
Morocco SDoC Declaration	<a href="https://globtek.secure.force.com/models/Morocco_SDoC_Declaration?id=a003a00000LtuiNEAR">https://globtek.secure.force.com/models/Morocco_SDoC_Declaration?id=a003a00000LtuiNEAR</a>
RoHS/RoHS3 Declaration	<a href="https://www.globtek.com/pdf/rohs_cert/01t3a000004eNhlAAU">https://www.globtek.com/pdf/rohs_cert/01t3a000004eNhlAAU</a>
REACH Declaration	<a href="https://www.globtek.com/pdf/iso_certificates/REACH.pdf">https://www.globtek.com/pdf/iso_certificates/REACH.pdf</a>
Conflict Minerals Declaration	<a href="https://www.globtek.com/pdf/conflict-minerals.pdf">https://www.globtek.com/pdf/conflict-minerals.pdf</a>
Prop 65 Statement	<a href="https://en.globtek.com/prop-65-statement.pdf">https://en.globtek.com/prop-65-statement.pdf</a>

IPXY rating is based on 3rd party testing and customers should check suitability and test system level IPXY rating before ordering.

## Regulatory Certifications/Label Markings

Below follows a link to the latest regulatory certifications and marks for this specific product. National standards as well as certification schemes are constantly changing and so is the set of certification marks and symbols applicable to this product. Various standards, marks and symbols, and certificates are subject to change at any time without notice.

Additional standards or unique country certifications are available upon request. Please contact Globtek to request a quotation.

LATEST PRODUCT/MODEL CERTIFICATIONS:	<a href="https://www.globtek.com/datasheet/w70572">https://www.globtek.com/datasheet/w70572</a>
AGENCY ONLINE DOCUMENTS	<a href="http://www.globtek.info/certs/GT-83084-USB-W2Z/">http://www.globtek.info/certs/GT-83084-USB-W2Z/</a>



(F1) Class II / Double Insulated



BC 1.2 compliant Dedicated Charging Port (DCP)  
This port does not support any data transfer, but is capable of supplying charge currents beyond 1.5A.

It features a short between the D+ and D- lines.  
This type of port allows for wall chargers and car chargers with high-charge capability without the need for enumeration.

Pin 1:(+), Pin 2 (D-): Connected to Pin 3 (D+), Pin 3 (D+): Connected to Pin 2 (D-), Pin 4:(-);  
P2 (D-) and P3 (D+) are shorted together inside power supply.

GlobTek, Inc. www.globtek.com 186 Veterans Drive, Northvale, NJ 07647 Tel. (201) 784-1000 Fax (201) 784-0111	Drawing Title: GT-83084-0806-0.8-USB-W2IN, ICT/ITE Power Supply, Efficiency Level: USA DOE Level VI / Eco-design Directive 2009/125/EC, (EU) 2019/1782, Case Color/Style: GlobTek Black, Wall Plug-in, AC/DC Switching Adapter with USB Power Supply AC Adaptor, Input Rating: 100-240V- , 50/60Hz, India Fixed , Output Rating: 7.8W, 5.2V@1.5A, Output Configuration: N/A mm, N/A/4 Cond, N/A, Type "A" USB "JACK", integral to power supply enclosure, Ferrite: None, N/A, GT Cord # C0132, Pin Out: Pin 1:(+), Pin 2 (D-): Connected to Pin 3 (D+), Pin 3 (D+): Connected to Pin 2 (D-), Pin 4:(-); P2 (D-) and P3 (D+) are shorted together inside power supply., Blades/Input Cord: Fixed Blades India 2 Conductor, Approvals: RoHS; CE; China RoHS; Double Insulation; EAC; Level VI; WEEE; SIQ; CB 60950; India; CB 62368; LPS 62368;	
	Model No. GT-83084-0806-0.8-USB-W2IN	
	Part No./Ordering No. WR9WA1500U53INF(R6B)	Rev A1

## PACKAGING

Packing Spec P/N:

Box Qty	300
Gift Box Size (mm):	N/A
Gift Box Color:	None
Master Carton Size (mm):	455 x 325 x 257
Master Carton Cubic Volume (m <sup>3</sup> ):	0.04
Master GW (Kg):	12.0 kg
BLADES INCLUDED:	FBIndia2: Fixed Blades India 2 Conductor
BLADE/CORD INSTALLED:	FBIndia2: Fixed Blades India 2 Conductor
USER MANUAL*:	
USER MANUAL WEB LINK:	

\* This specification sheet is considered the user manual for all applications. It is expected that the buyer of this product will use it to formulate their own user manual for their end product and a user manual specifically for the power adapter is not usually required. If a user manual is not specifically listed above then none will be provided with this unit.

### PROPRIETARY INFORMATION

<p>GlobTek, Inc. www.globtek.com 186 Veterans Drive, Northvale, NJ 07647 Tel. (201) 784-1000 Fax (201) 784-0111</p>	<p>Drawing Title: GT-83084-0806-0.8-USB-W2IN, ICT/ITE Power Supply, Efficiency Level: USA DOE Level VI / Eco-design Directive 2009/125/EC, (EU) 2019/1782, Case Color/Style: GlobTek Black, Wall Plug-in, AC/DC Switching Adapter with USB Power Supply AC Adaptor, Input Rating: 100-240V- , 50/60Hz, India Fixed , Output Rating: 7.8W, 5.2V@1.5A, Output Configuration: N/A mm, N/A/4 Cond, N/A, Type "A" USB "JACK", integral to power supply enclosure, Ferrite: None, N/A, GT Cord # C0132, Pin Out: Pin 1:(+), Pin 2 (D-): Connected to Pin 3 (D+), Pin 3 (D+): Connected to Pin 2 (D-), Pin 4:(-); P2 (D-) and P3 (D+) are shorted together inside power supply., Blades/Input Cord: Fixed Blades India 2 Conductor, Approvals: RoHS; CE; China RoHS; Double Insulation; EAC; Level VI; WEEE; SIQ; CB 60950; India; CB 62368; LPS 62368;</p>
	<p>Model No. GT-83084-0806-0.8-USB-W2IN</p>
	<p>Part No./Ordering No. WR9WA1500U53INF(R6B) <span style="float: right;">Rev A1</span></p>

## INSTRUCTIONS TO THE OEM SYSTEMS ENGINEER

It is the responsibility of the OEM systems engineer to provide the end system user instructions and warnings for the use of this product in the end system.

If an input cord is required for this product, AC Mains voltage should be provided to the power supply by a power supply cord approved to the national standards of the country in which it will be used.

This product is not designed to be repaired. No serviceable parts inside. A blown internal fuse is an indication of catastrophic failure of circuit component(s). If a Failure Analysis is required for a failed power supply/battery charger, please return the damaged unit to GlobTek for an accurate determination of the root cause of the failure.

EMC Compliance of the complete OEM product, including the GlobTek power supply/battery charger needs to be verified by the OEM systems engineer.

## INSTRUCTION SHEET

N/A

<p>GlobTek, Inc.  www.globtek.com  186 Veterans Drive,  Northvale, NJ 07647  Tel. (201) 784-1000  Fax (201) 784-0111</p>	Drawing Title: GT-83084-0806-0.8-USB-W2IN, ICT/ITE Power Supply, Efficiency Level: USA DOE Level VI / Eco-design Directive 2009/125/EC, (EU) 2019/1782, Case Color/Style: GlobTek Black, Wall Plug-in, AC/DC Switching Adapter with USB Power Supply AC Adaptor, Input Rating: 100-240V- , 50/60Hz, India Fixed , Output Rating: 7.8W, 5.2V@1.5A, Output Configuration: N/A mm, N/A/4 Cond, N/A, Type "A" USB "JACK", integral to power supply enclosure, Ferrite: None, N/A, GT Cord # C0132, Pin Out: Pin 1:(+), Pin 2 (D-): Connected to Pin 3 (D+), Pin 3 (D+): Connected to Pin 2 (D-), Pin 4:(-); P2 (D-) and P3 (D+) are shorted together inside power supply., Blades/Input Cord: Fixed Blades India 2 Conductor, Approvals: RoHS; CE; China RoHS; Double Insulation; EAC; Level VI; WEEE; SIQ; CB 60950; India; CB 62368; LPS 62368;	
	Model No. GT-83084-0806-0.8-USB-W2IN	
	Part No./Ordering No. WR9WA1500U53INF(R6B)	Rev A1

