

APPROVED: _____
 DATE: _____ TITLE: _____

Rev	AWO #	Description	Date	Appr
-		RELEASED	2/23/16	

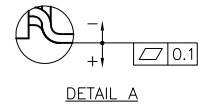

Note:
 0.4mm compression
 required to fully
 seat O-Ring

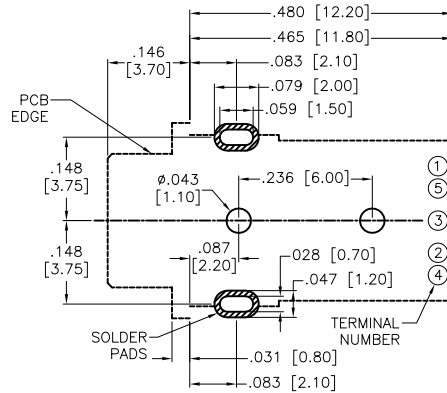
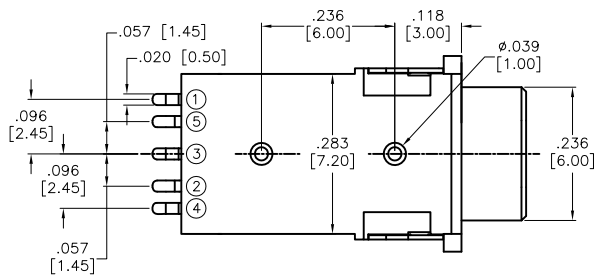
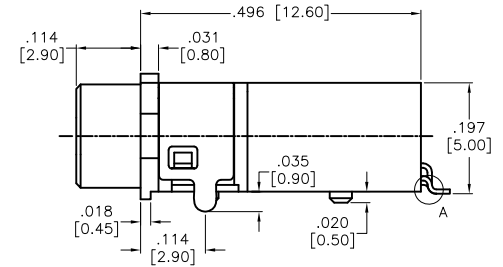
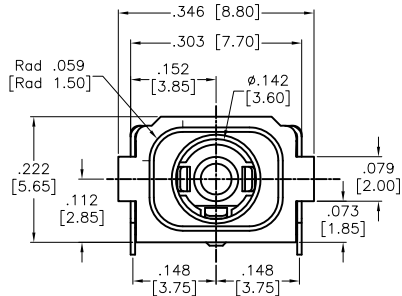
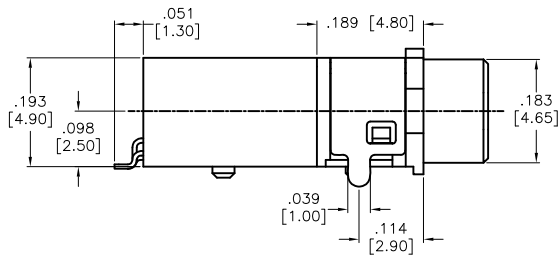
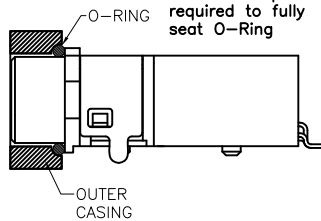

RECOMMENDED PCB LAYOUT

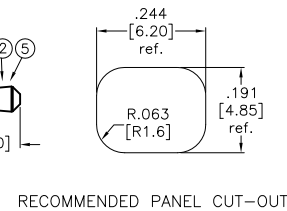
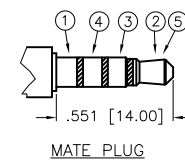
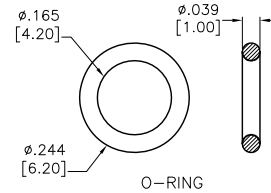

SPECIFICATIONS:

Material:
 Insulator: Hi-Temp Thermoplastic, Rated UL94V-0
 Insulator Color: Black
 Contacts: Copper Alloy
 Shield: Brass, Nickel plated
 O-Ring: Silicone, 94V-0
 Plating:
 Gold Flash over Nickel underplate overall
 Electrical:
 Rating: 12 VDC, 1A max.
 Contact Resistance: 50 mohm Max intinal
 Insulation Resistane: 100 Mohm Min @ 500 VDC
 Dielectric Withstanding Voltage: 500 VRMS For 1 Minute.
 Temperature Rating:
 Operating temperature: -25°C to +85°C
 Environmental:
 Waterproof Rating: IP67
 Lead free, RoHS compliant.

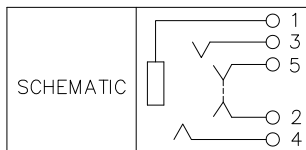

UNLESS OTHERWISE SPECIFIED ALL DIMENSIONS ARE INCHES [MM] TOLERANCES: EXCEPT AS NOTED		
INCHES		HOLES
.X ± .10	∅X ± .10	
.XX ± .020	∅XX ± .015	
.XXX ± .015	∅XXX ± .010	
APPROVALS		DATE
DRAWN	HR	2/23/16
CHECKED	TW	2/23/16
APPROVED		

ADAM TECH
 909 Rahway Avenue, Union, NJ 07083
 Phone: 908-687-5000 Fax: 908-687-5710

TITLE: **3.5MM WATERPROOF STEREO JACK**
WATERPROOF RATE: IP67

SIZE X	PART NO. ASJ-181-1A-HDW-WP	REV. -
REF: S00021C	SCALE: NTS	SHEET 1 OF 1