

DESCRIPTION

The MP21600 is a monolithic, step-down, switch-mode converter with built-in, internal power MOSFETs. The MP21600 achieves 0.6A of continuous output current from a 2.3V to 5.5V input voltage range with excellent load and line regulation. The output voltage can be regulated as low as 0.6V.

The constant-on-time (COT) control scheme provides fast transient response and eases loop stabilization. Fault protections include cycle-by-cycle current limiting and thermal shutdown.

The MP21600 is ideal for a wide range of applications, including high-performance DSPs, wireless power, portable and mobile devices, and other low-power systems.

The MP21600 requires a minimal number of readily available, standard, external components is available in an ultra-small QFN-6 (1.0mmx1.5mm) package.

FEATURES

- Low I_Q: 11 μ A
- 2.4MHz Switching Frequency
- Enable (EN) Pin for Power Sequencing
- Wide 2.3V to 5.5V Operating Input Range
- Output Adjustable from 0.6V
- Up to 0.6A Output Current
- 120m Ω and 80m Ω Internal Power MOSFET Switches
- Output Discharge
- 100% Duty Cycle
- Short-Circuit Protection (SCP) with Hiccup Mode
- Stable with Low ESR Output Ceramic Capacitors
- Available in a QFN-6 (1.0mmx1.5mm) Package

APPLICATIONS

- Wireless/Networking Cards
- Portable and Mobile Devices
- Battery-Powered/Wearable Devices
- Low-Voltage I/O System Power

All MPS parts are lead-free, halogen-free, and adhere to the RoHS directive. For MPS green status, please visit the MPS website under Quality Assurance. "MPS" and "The Future of Analog IC Technology" are registered trademarks of Monolithic Power Systems, Inc.

TYPICAL APPLICATION

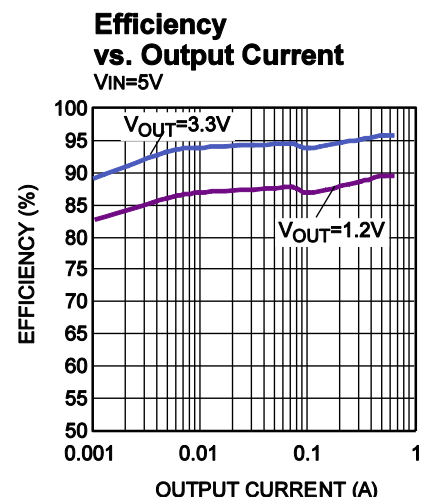
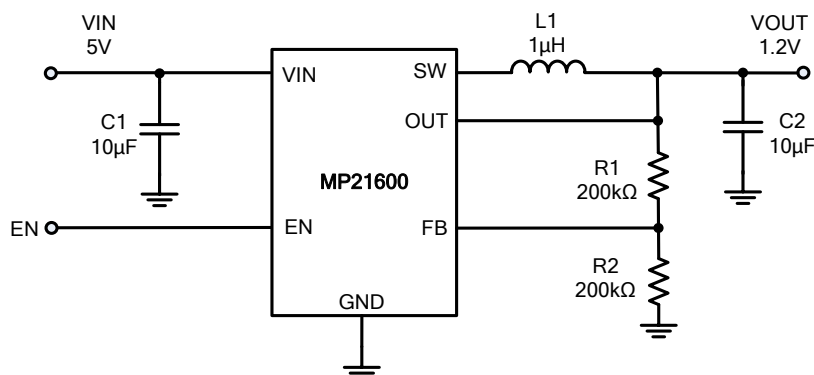

ORDERING INFORMATION

Part Number*	Package	Top Marking
MP21600GQD	QFN-6 (1.0mmx1.5mm)	See Below

* For Tape & Reel, add suffix -Z (e.g. MP21600GQD-Z)

TOP MARKING

—
FC
LL

FC: Product code of MP21600GQD

LL: Lot number

PACKAGE REFERENCE

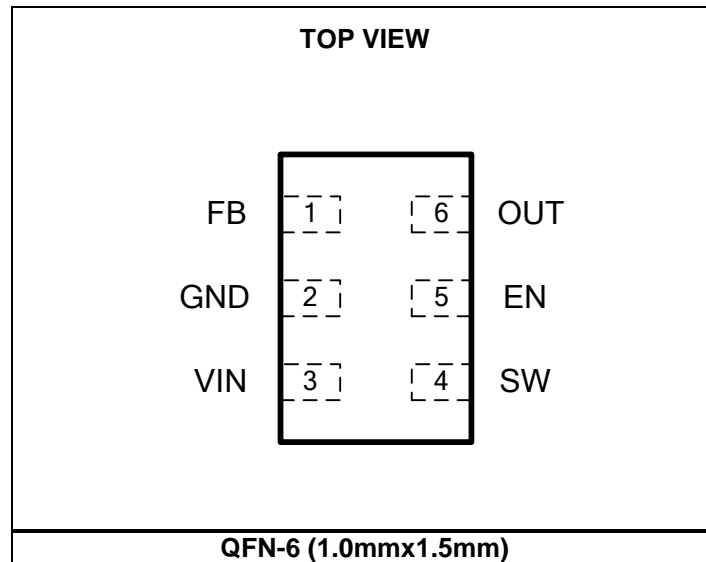

ABSOLUTE MAXIMUM RATINGS ⁽¹⁾

Supply voltage (V _{IN}).....	6V
V _{SW}	-0.3V (-5V for <10ns) to 6V (8V for <10ns or 10V for <3ns)
All other pins.....	-0.3V to 6V
Junction temperature	150°C
Lead temperature	260°C
Continuous power dissipation (T _A = +25°C) ⁽²⁾	0.6W
Storage temperature.....	-65°C to +150°C

Recommended Operating Conditions ⁽³⁾

Supply voltage (V _{IN}).....	2.3V to 5.5V
Operating junction temp. (T _J) ..	-40°C to +125°C

Thermal Resistance ⁽⁴⁾	θ_{JA}	θ_{JC}
QFN-6 (1.0mmx1.5mm)	220.....	110 .. °C/W

NOTES:

- 1) Exceeding these ratings may damage the device.
- 2) The maximum allowable power dissipation is a function of the maximum junction temperature T_J (MAX), the junction-to-ambient thermal resistance θ_{JA} , and the ambient temperature T_A. The maximum allowable continuous power dissipation at any ambient temperature is calculated by P_D (MAX) = (T_J (MAX)-T_A)/ θ_{JA} . Exceeding the maximum allowable power dissipation produces an excessive die temperature, causing the regulator to go into thermal shutdown. Internal thermal shutdown circuitry protects the device from permanent damage.
- 3) The device is not guaranteed to function outside of its operating conditions.
- 4) Measured on JESD51-7, 4-layer PCB.

ELECTRICAL CHARACTERISTICS

V_{IN} = 3.6V, T_J = -40°C to +125°C, typical value is tested at T_J = +25°C. The limit over temperature is guaranteed by characterization, unless otherwise noted.

Parameter	Symbol	Condition	Min	Typ	Max	Units
Feedback voltage	V _{FB}	2.3V ≤ V _{IN} ≤ 5.5V, T _J = 25°C	594	600	606	mV
		T _J = -40°C to +125°C	588		612	
Feedback current	I _{FB}	V _{FB} = 0.63V		50	100	nA
PFET switch on resistance	R _{DSON_P}			120		mΩ
NFET switch on resistance	R _{DSON_N}			80		mΩ
Switch leakage current		V _{EN} = 0V, T _J = 25°C		0	1	μA
PFET peak current limit		Sourcing	1	1.3	1.6	A
NFET valley current limit		Sourcing, valley current limit		0.4		A
ZCD ⁽⁶⁾				0		mA
On time	T _{ON}	V _{IN} = 5V, V _{OUT} = 1.2V		100		ns
		V _{IN} = 3.6V, V _{OUT} = 1.2V		135		
Switching frequency	f _s	V _{OUT} = 1.2V	1920	2400	2910	kHz
		V _{OUT} = 1.2V, T _J = -40°C to +125°C ⁽⁵⁾	1800	2400	3000	
Minimum off time	T _{MIN-OFF}			60		ns
Minimum on time ⁽⁵⁾	T _{MIN-ON}			60		ns
Soft-start time	T _{SS-ON}	V _{OUT} rise from 10% to 90%		0.5		ms
Under-voltage lockout threshold rising				2	2.25	V
Under-voltage lockout threshold hysteresis				150		mV
EN input logic low voltage					0.4	V
EN input logic high voltage			1.2			V
Output discharge resistor	R _{DIS}	V _{EN} = 0V, V _{OUT} = 1.2V		1		kΩ
EN input current		V _{EN} = 2V		1.2		μA
		V _{EN} = 0V		0		μA
Supply current (shutdown)		V _{EN} = 0V, T _J = 25°C		0	1	μA
Supply current (quiescent)		V _{EN} = 2V, V _{FB} = 0.63V, V _{IN} = 3.6V, 5V, T _J = 25°C		11	13	μA
Thermal shutdown ⁽⁶⁾				160		°C
Thermal hysteresis ⁽⁶⁾				30		°C

NOTES:

5) Guaranteed by characterization.

6) Guaranteed by design.

TYPICAL PERFORMANCE CHARACTERISTICS

V_{IN} = 5V, V_{OUT} = 1.2V, L = 1.0µH, T_A = +25°C, unless otherwise noted.

Efficiency vs. Output Current

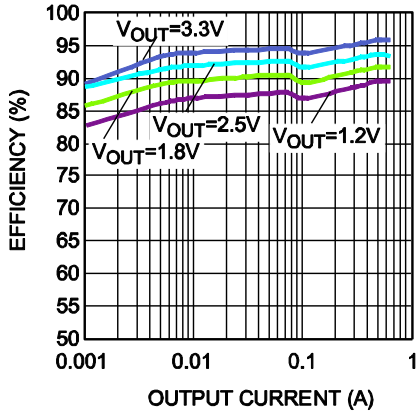

Efficiency vs. Output Current

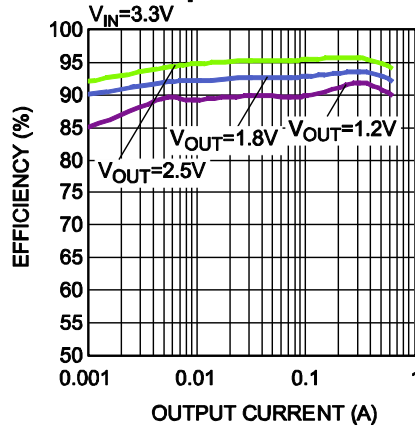

Load Regulation vs. Output Current

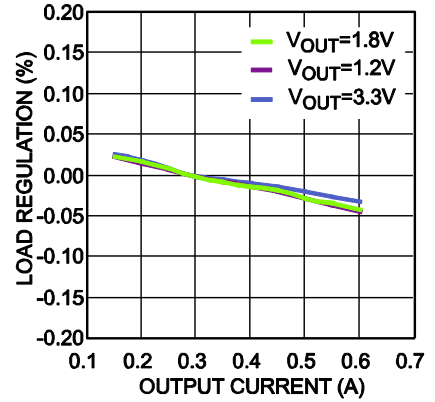

Line Regulation vs. Input Voltage

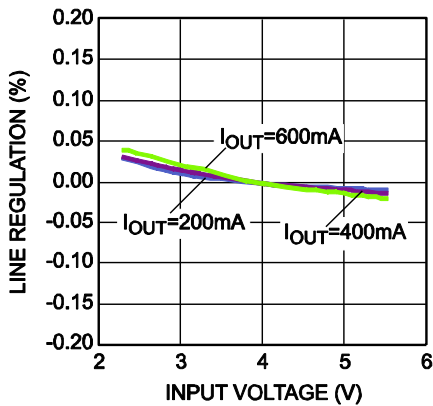

Quiescent Current vs. Input Voltage

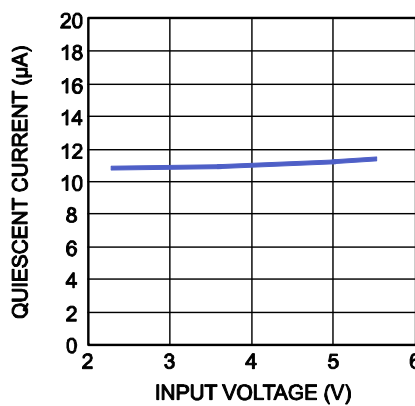

Shutdown Current vs. Input Voltage

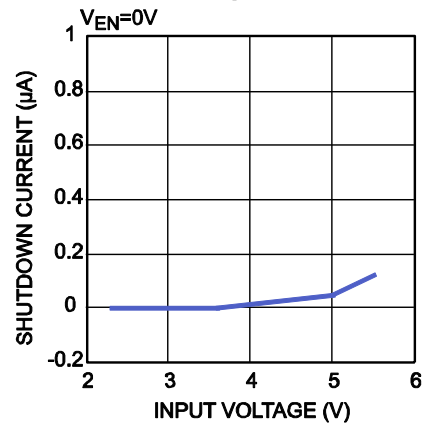

Current Limit vs. Input Voltage

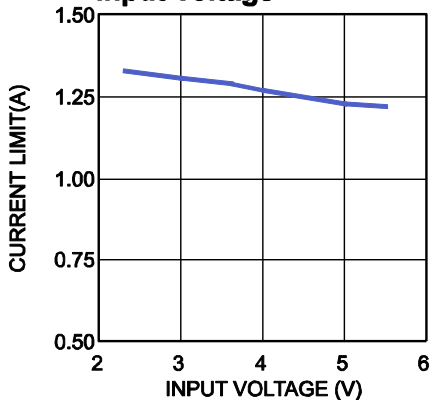

Quiescent Current vs. Temperature

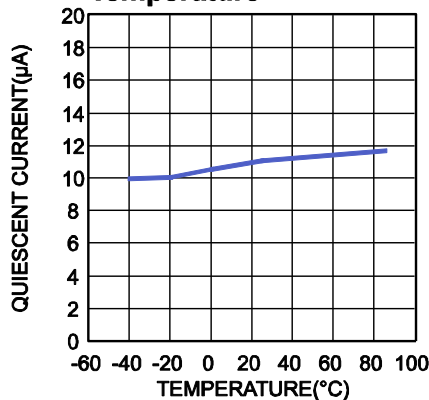

VIN UVLO Rising Threshold vs. Temperature

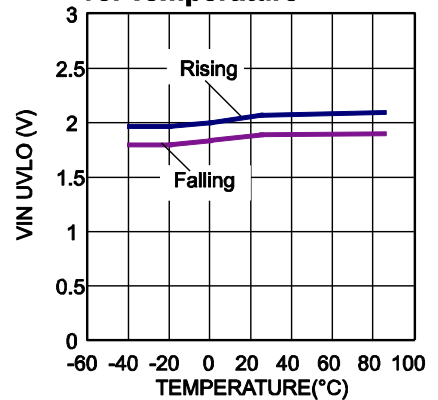

TYPICAL PERFORMANCE CHARACTERISTICS (continued)

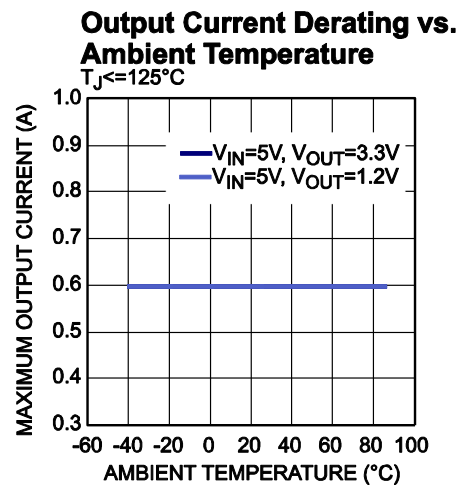
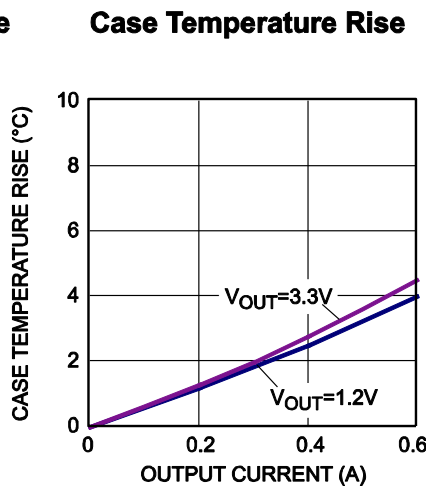
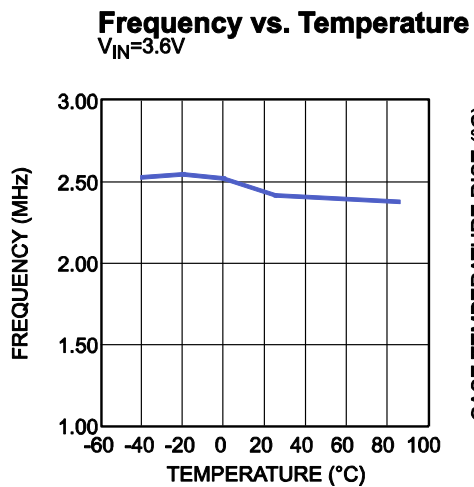
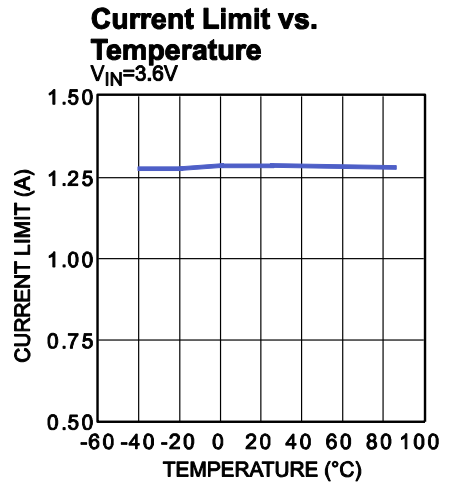
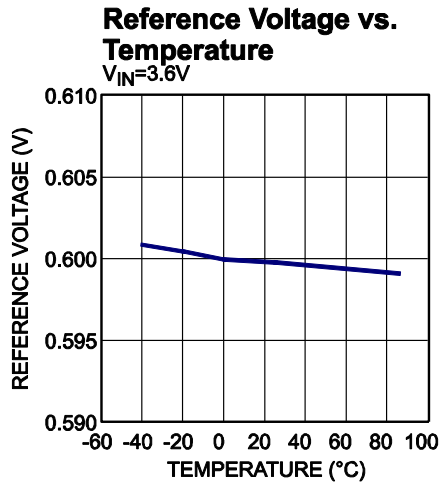
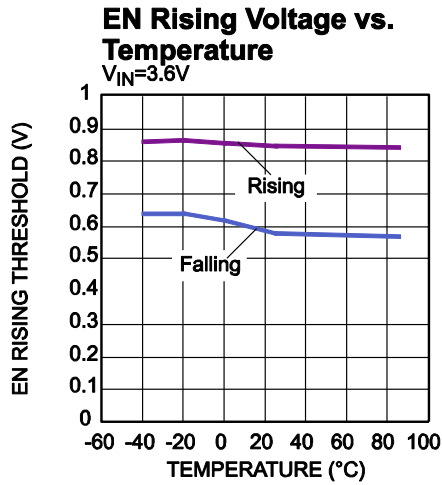
 V_{IN} = 5V, V_{OUT} = 1.2V, L = 1.0µH, T_A = +25°C, unless otherwise noted.

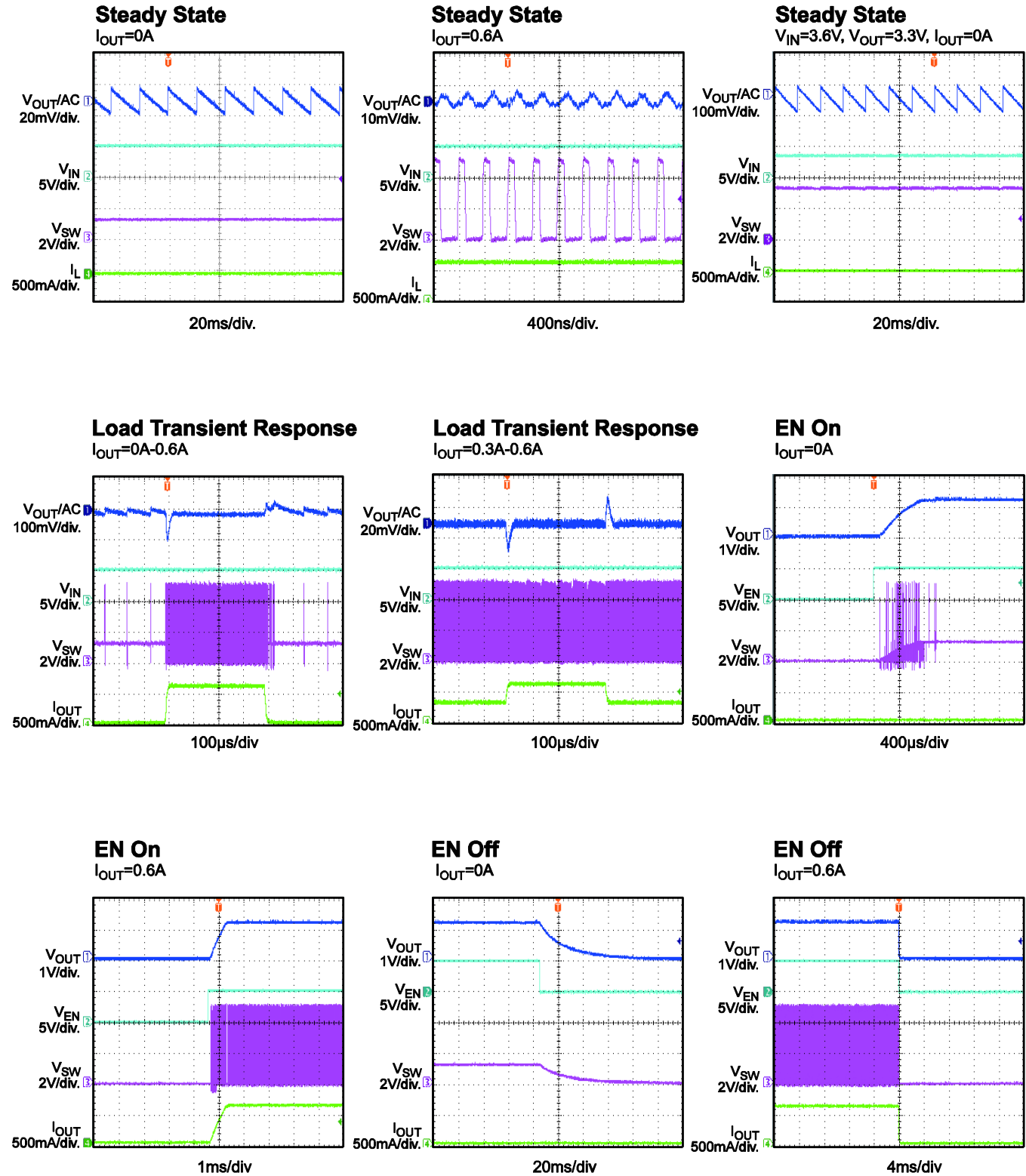
TYPICAL PERFORMANCE CHARACTERISTICS (continued)
 $V_{IN} = 5V$, $V_{OUT} = 1.2V$, $L = 1.0\mu H$, $C_o = 22\mu F$, $T_A = +25^\circ C$, unless otherwise noted.

TYPICAL PERFORMANCE CHARACTERISTICS (continued)

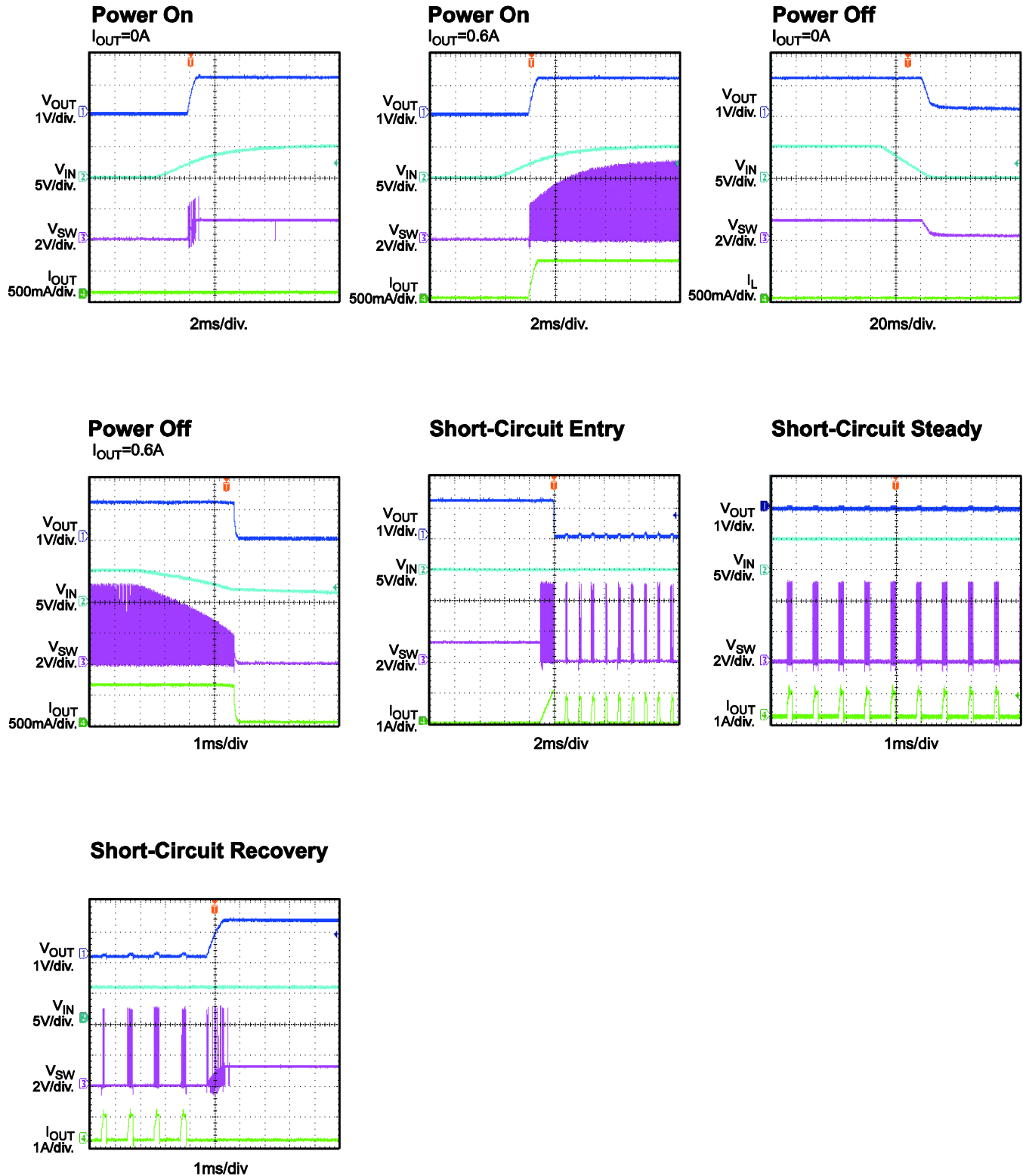
 VIN = 5V, V_{OUT} = 1.2V, L = 1.0 μ H, Co = 22 μ F, T_A = +25°C, unless otherwise noted.

PIN FUNCTIONS

Pin #	Name	Description
1	FB	Feedback. An external resistor divider from the output to GND tapped to FB sets the output voltage.
2	GND	Power ground.
3	VIN	Supply voltage. The MP21600 operates from a 2.3V to 5.5V unregulated input. A decouple capacitor is needed to prevent large voltage spikes from appearing at the input.
4	SW	Output switching node. SW is the drain of the internal, high-side, P-channel MOSFET. Connect the inductor to SW to complete the converter.
5	EN	On/off control.
6	OUT	Output voltage power rail and input sense for output voltage. Connect the load to OUT. An output capacitor is needed to decrease the output voltage ripple.

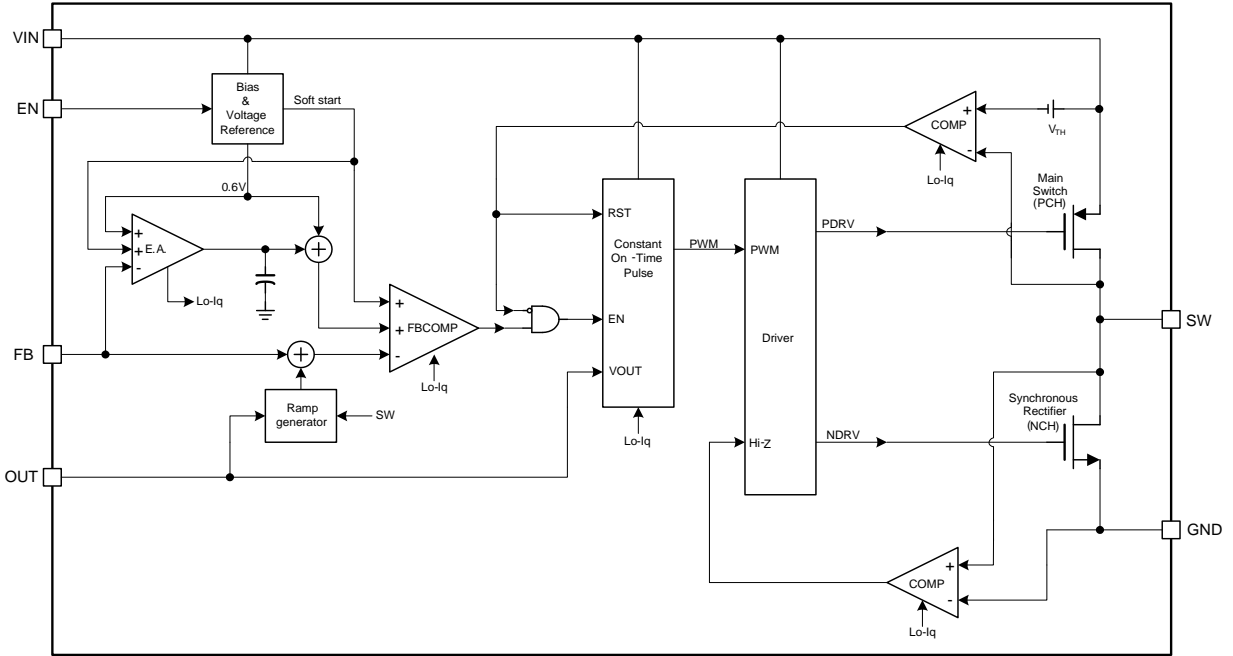
BLOCK DIAGRAM

Figure 1: Functional Block Diagram

OPERATION

The MP21600 uses constant-on-time (COT) control with input voltage feed-forward to stabilize the switching frequency over the full input range. The MP21600 achieves 0.6A of continuous output current from a 2.3V to 5.5V input voltage range with excellent load and line regulation. The output voltage can be regulated as low as 0.6V.

Constant-On-Time (COT) Control

Compared to fixed-frequency pulse-width modulation (PWM) control, constant-on-time (COT) control offers a simpler control loop and a faster transient response. By using input-voltage feed-forward, the MP21600 maintains a nearly constant switching frequency across the input and output voltage ranges. The switching pulse on time can be estimated with Equation (1):

$$T_{ON} = \frac{V_{OUT}}{V_{IN}} \cdot 0.416\mu s \quad (1)$$

To prevent inductor current runaway during the load transient, the MP21600 has a fixed minimum off time of 60ns.

Sleep Mode Operation

The MP21600 features sleep mode to achieve high efficiency at extremely light loads. In sleep mode, most of the circuit blocks are turned off, except for the error amplifier (EA) and PWM comparator. Therefore, the operation current is reduced to a minimal value (see Figure 2).

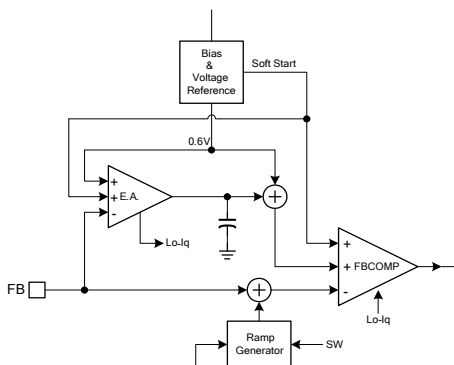

Figure 2: Operation Blocks in Sleep Mode

When the load becomes lighter, the ripple of the output voltage is larger and drives the error amplifier output (EAO) lower. When the EAO reaches an internal low threshold, it is clamped

at that level, and the MP21600 enters sleep mode. During sleep mode, the valley of the FB voltage is regulated to the internal reference voltage, making the average output voltage slightly higher than the output voltage at discontinuous conduction mode (DCM) or continuous conduction mode (CCM). The on-time pulse at sleep mode is around 40% larger than that in DCM or CCM. Figure 3 shows the average FB voltage relationship with the internal reference in sleep mode.

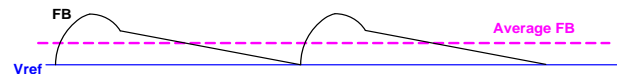

Figure 3: FB Average Voltage in Sleep Mode

When MP21600 is in sleep mode, the average output voltage is higher than the internal reference voltage. The EAO is kept low and clamped in sleep mode. When the loading increases, the PWM switching period decreases to keep the output voltage regulated, and the output voltage ripple is decreased relatively. When the EAO is greater than the internal low threshold, the MP21600 exits sleep mode and enters DCM or CCM depending on the load. In DCM or CCM, the EA regulates the average output voltage to the internal reference (see Figure 4).

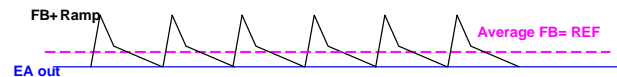

Figure 4: DCM Control

There is always a loading hysteresis when entering sleep mode and exiting sleep mode due to the EA clamping response time.

AAM Operation in Light-Load Operation

The MP21600 uses an advanced asynchronous modulation (AAM) power-save mode together with zero-current cross detection (ZCD) circuit for light loads.

The MP21600 uses AAM power-save mode for light loads (see Figure 5). The AAM current (I_{AAM}) is set internally. The SW on pulse time is decided by the on-time generator and AAM comparator. At light load condition, the SW on pulse time is the longer one. If the AAM comparator pulse is longer than the on-timer generator, the operation mode follows the diagram shown in Figure 6.

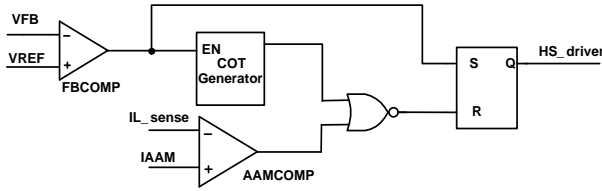
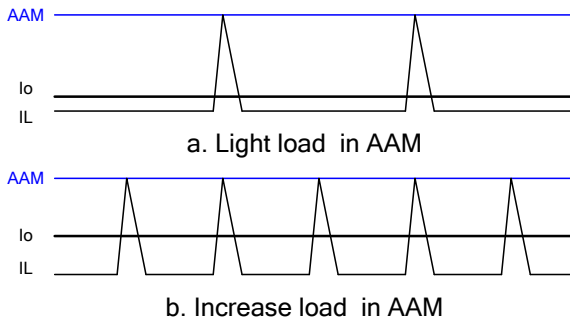
Figure 5: Simplified AAM Control Logic

Figure 6: AAM Comparator Control T_{ON}

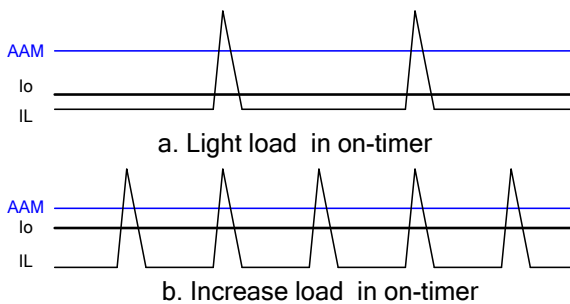
If the AAM comparator pulse is shorter than the on-time generator, the operation mode follows the diagram shown in Figure 7. Generally, this can occur by using a very small inductance.

Figure 7: On-Timer Control T_{ON}

In addition to the above on-timer method, the AAM circuit has another 150ns of AAM blank time in sleep mode. If the on-timer is less than 150ns, the high-side MOSFET (HS-FET) may turn off after the on-timer generator pulse without AAM control. In this condition, the inductor current (I_L) may not reach the AAM threshold (see Figure 8). The on-time pulse in sleep mode is around 40% larger than that the on-time pulse in DCM or CCM.

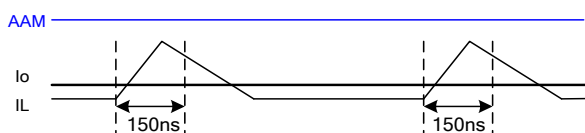
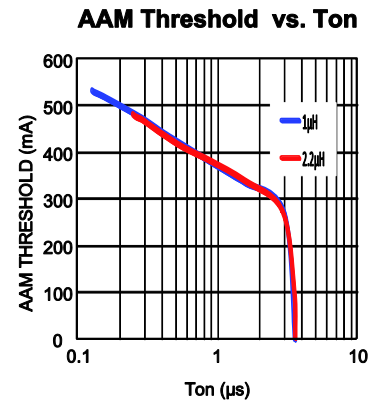

Figure 8: AAM Blank Time in Sleep Mode

Figure 9 shows the AAM threshold decreasing as T_{ON} increases gradually. For CCM, the output current (I_o) must be more than half of the AAM threshold at least.

Figure 9: AAM Threshold Decreases with T_{ON} Increase

The MP21600 has a ZCD to determine when the inductor current starts reversing. When the inductor current reaches the ZCD threshold, the low-side switch turns off. AAM and the ZCD circuit make the MP21600 work in DCM mode at light load continuously, even if V_{OUT} is close to V_{IN}.

Enable (EN)

When the input voltage is greater than the under-voltage lockout threshold (UVLO) (typically 2V), the MP21600 can be enabled by pulling EN higher than 1.2V. Leave EN floating or pull EN down to ground to disable the MP21600. There is an internal 1M Ω resistor from EN to ground. When the device is disabled, the part enters output discharge mode automatically. The internal discharge MOSFET provides a resistive discharge path for the output capacitor.

Soft Start (SS)

The MP21600 has a built-in soft start that ramps up the output voltage at a controlled slew rate to avoid overshooting at start-up. The soft start time is about 0.5ms, typically.

Current Limit

The MP21600 has a 1.3A high-side switch current limit, typically. When the high-side switch reaches its current limit, the MP21600 remains in hiccup mode until the current drops.

This prevents the inductor current from rising and damaging components.

Short Circuit and Recovery

The MP21600 enters short-circuit protection (SCP) mode when it reaches the current limit and attempts to recover with hiccup mode. The MP21600 disables the output power stage, discharges the soft-start capacitor, and attempts to soft start again automatically. If the short-circuit condition remains after the soft start ends, the MP21600 repeats this cycle until the short circuit is removed and the output rises back to the regulation level.

APPLICATION INFORMATION

Setting the Output Voltage

The external resistor divider sets the output voltage (see the Typical Application Circuit in Figure 12). Select a feedback resistor (R1) to reduce the V_{OUT} leakage current, typically between 100kΩ to 200kΩ. There is no strict requirement on the feedback resistor. An R1 value greater than 10kΩ is reasonable for the application. R2 can then be calculated with Equation (2):

$$R2 = \frac{R1}{\frac{V_{out}}{0.6} - 1} \quad (2)$$

Figure 10 shows the feedback circuit.

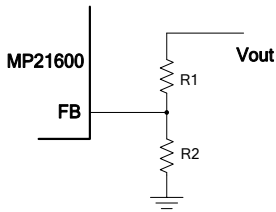

Figure 10: Feedback Network

Table 1 lists the recommended resistor values for common output voltages.

Table 1: Resistor Values for Common Output Voltages

V _{OUT} (V)	R1 (kΩ)	R2 (kΩ)
1.0	200(1%)	300(1%)
1.2	200(1%)	200(1%)
1.8	200(1%)	100(1%)
2.5	200(1%)	63.2(1%)
3.3	200(1%)	44.2(1%)

Selecting the Inductor

Most applications work best with a 0.47µH to 1.5µH inductor. Select an inductor with a DC resistance less than 100mΩ to optimize efficiency. High-frequency, switch-mode power supplies with a magnetic device have strong electronic magnetic inference for the system. Any unshielded power inductor should be avoided since it has poor magnetic shielding. Metal alloy or multiplayer chip power shield inductors are recommended for the application since they can decrease influence effectively. Table 2 lists some suggested inductors.

Table 2: Suggested Inductor List

Manufacturer P/N	Inductance(µH)	Manufacturer
PIFE25201B-1R0MS	1.0	CYNTEC CO. LTD.
1239AS-H-1R0M	1.0	Tokyo
74438322010	1.0	Würth

For most designs, the inductance can be estimated with Equation (3):

$$L_1 = \frac{V_{OUT} \times (V_{IN} - V_{OUT})}{V_{IN} \times \Delta I_L \times f_{OSC}} \quad (3)$$

Where ΔI_L is the inductor ripple current.

Choose the inductor current to be approximately 30% of the maximum load current. The maximum inductor peak current can be calculated with Equation (4):

$$I_{L(MAX)} = I_{LOAD} + \frac{\Delta I_L}{2} \quad (4)$$

Selecting the Input Capacitor

The input current to the step-down converter is discontinuous, and therefore requires a capacitor to supply AC current to the step-down converter while maintaining the DC input voltage. Use low ESR capacitors for the best performance. Ceramic capacitors with X5R or X7R dielectrics are highly recommended because of their low ESR and small temperature coefficients. For most applications, a 10µF capacitor is sufficient. Higher output voltages may require a 22µF capacitor to increase system stability.

The input capacitor requires an adequate ripple current rating since it absorbs the input switching current. Estimate the RMS current in the input capacitor with Equation (5):

$$I_{C1} = I_{LOAD} \times \sqrt{\frac{V_{OUT}}{V_{IN}} \times \left(1 - \frac{V_{OUT}}{V_{IN}}\right)} \quad (5)$$

The worst-case scenario occurs at V_{IN} = 2V_{OUT}, shown in Equation (6):

$$I_{C1} = \frac{I_{LOAD}}{2} \quad (6)$$

For simplification, choose an input capacitor with an RMS current rating greater than half of the maximum load current.

The input capacitor can be electrolytic, tantalum, or ceramic. When using electrolytic or tantalum capacitors, add a small, high-quality, 0.1µF, ceramic capacitor as close to the IC as possible. When using ceramic capacitors, ensure that they have enough capacitance to provide sufficient charge to prevent excessive voltage ripple at the input. The input voltage ripple caused by the capacitance can be estimated with Equation (7):

$$\Delta V_{IN} = \frac{I_{LOAD}}{f_s \times C1} \times \frac{V_{OUT}}{V_{IN}} \times \left(1 - \frac{V_{OUT}}{V_{IN}}\right) \quad (7)$$

Selecting the Output Capacitor

The output capacitor (C2) stabilizes the DC output voltage. Low ESR ceramic capacitors are recommended to limit the output voltage ripple. Estimate the output voltage ripple with Equation (8):

$$\Delta V_{OUT} = \frac{V_{OUT}}{f_s \times L_1} \times \left(1 - \frac{V_{OUT}}{V_{IN}}\right) \times \left(R_{ESR} + \frac{1}{8 \times f_s \times C2}\right) \quad (8)$$

Where L₁ is the inductor value, and R_{ESR} is the equivalent series resistance (ESR) value of the output capacitor.

When using ceramic capacitors, the capacitance dominates the impedance at the switching frequency and causes most of the output voltage ripple. For simplification, the output voltage ripple can be estimated with Equation (9):

$$\Delta V_{OUT} = \frac{V_{OUT}}{8 \times f_s^2 \times L_1 \times C2} \times \left(1 - \frac{V_{OUT}}{V_{IN}}\right) \quad (9)$$

For tantalum or electrolytic capacitors, the ESR dominates the impedance at the switching frequency. For simplification, the output ripple can be approximated with Equation (10):

$$\Delta V_{OUT} = \frac{V_{OUT}}{f_s \times L_1} \times \left(1 - \frac{V_{OUT}}{V_{IN}}\right) \times R_{ESR} \quad (10)$$

The characteristics of the output capacitor also affect the stability of the regulation system. For the MP21600, one 10µF output capacitor is sufficient for most applications. Considering the small solution size and light-load ripple, a 22µF capacitor is recommended.

PCB Layout Guidelines

Efficient layout of the switching power supplies is critical for stable operation. For the high-frequency switching converter, a poor layout design can result in poor line or load regulation and stability issues. For best results, refer to Figure 11 and follow the guidelines below.

1. Place the high-current paths (GND, VIN and SW) very close to the device with short, direct, and wide traces.
2. Place the input capacitor as close to VIN and GND as possible.
3. Place the external feedback resistors next to FB.
4. Keep the switching node (SW) short and away from the feedback network.
5. Keep the V_{OUT} sense line need as short as possible or away from the power inductor and surrounding inductors.

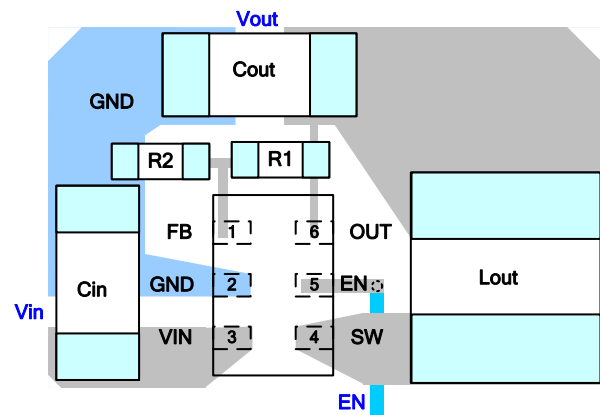

Figure 11: Two Ends of Input Decoupling Capacitor Close to Pin 2 and Pin 3

TYPICAL APPLICATION CIRCUIT

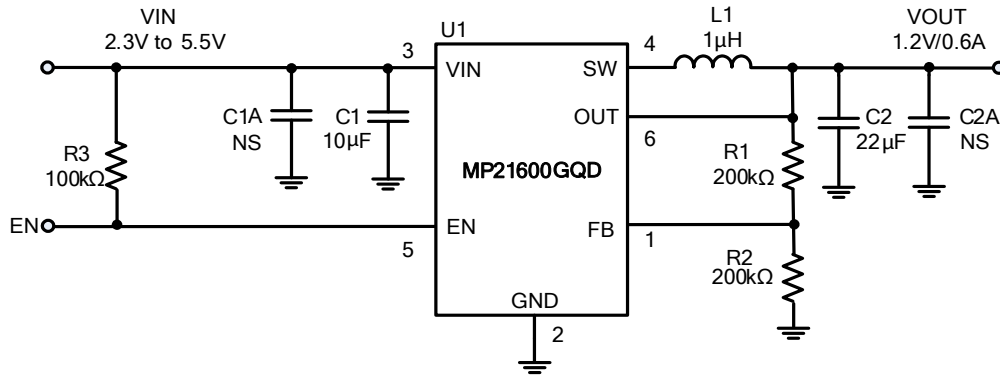
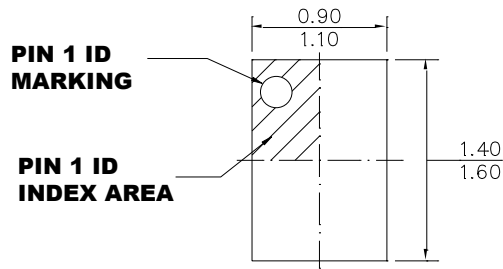

Figure 12: Typical Application Circuit

NOTE: VIN < 3.3V may require more input capacitors.

PACKAGE INFORMATION

QFN-6 (1.0mmx1.5mm)



TOP VIEW

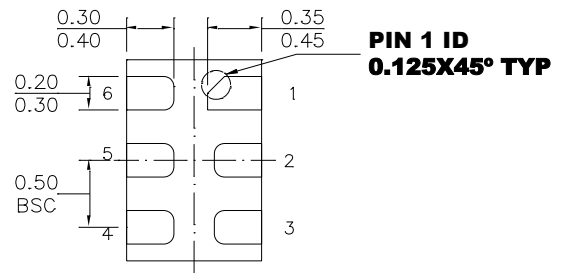

BOTTOM VIEW

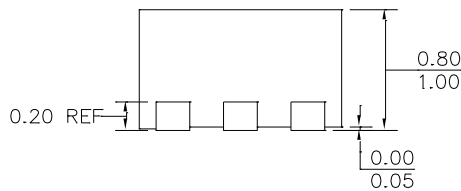

SIDE VIEW

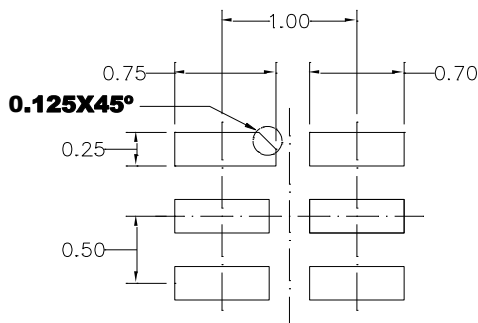

RECOMMENDED LAND PATTERN

NOTE:

- 1) ALL DIMENSIONS ARE IN MILLIMETERS.
- 2) EXPOSED PADDLE SIZE DOES NOT INCLUDE MOLD FLASH.
- 3) LEAD COPLANARITY SHALL BE 0.10 MILLIMETERS MAX.
- 4) JEDEC REFERENCE IS MO-220.
- 5) DRAWING IS NOT TO SCALE.

NOTICE: The information in this document is subject to change without notice. Please contact MPS for current specifications. Users should warrant and guarantee that third party Intellectual Property rights are not infringed upon when integrating MPS products into any application. MPS will not assume any legal responsibility for any said applications.