

CAS300M17BM2

1700 V, 8.0 mΩ, Silicon Carbide, Half-Bridge Module

V_{DS}	1700 V
I_{DS}	300 A

Technical Features

- Industry Standard 62mm Footprint
- Ultra Low Loss, High-Frequency Operation
- Zero Reverse Recovery from Diodes
- Zero Turn-off Tail Current from MOSFET
- Normally-off, Fail-safe Device Operation
- Copper Baseplate and Aluminum Nitride Insulator

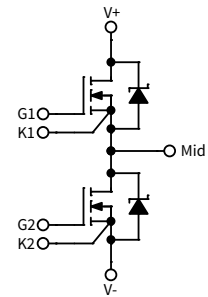

Applications

- HF Resonant Converters/Inverters
- Solar and Wind Inverters
- UPS and SMPS
- Motor Drive
- Traction

System Benefits

- Enables Compact and Lightweight Systems
- High Efficiency Operation
- Mitigates Over-voltage Protection
- Reduced Thermal Requirements
- Reduced System Cost

Maximum Parameters (Verified by Design)

Parameter	Symbol	Min.	Typ.	Max.	Unit	Test Conditions	Note
Drain-Source Voltage	V_{DS}			1700	V		
Gate-Source Voltage, Maximum Values	$V_{GS\ max}$	-10		+25			
Gate-Source Voltage, Recommended Values	$V_{GS\ op}$	-5		+20			
DC Continuous Drain Current	I_D		325		A	$V_{GS} = 20\ V, T_C = 25\ ^\circ C$	Fig. 26
			225			$V_{GS} = 20\ V, T_C = 90\ ^\circ C$	
DC Source-Drain Current (Body Diode)	$I_{SD\ BD}$		556			$V_{GS} = -5\ V, T_C = 25\ ^\circ C$	
			353			$V_{GS} = -5\ V, T_C = 90\ ^\circ C$	
Maximum Pulsed Drain-Source Current	$I_{D\ (pulsed)}$			900		Pulse width limited by $T_{VJ(max)}$	
Maximum Virtual Junction Temperature under Switching Conditions	$T_{VJ\ op}$	-40		150	$^\circ C$		

MOSFET Characteristics (Per Position) ($T_{VJ} = 25\text{ }^{\circ}\text{C}$ unless otherwise specified)

Parameter	Symbol	Min.	Typ.	Max.	Unit	Test Conditions	Note
Drain-Source Breakdown Voltage	$V_{(BR)DSS}$	1700			V	$V_{GS} = 0\text{ V}, I_{DS} = 2\text{ mA}$	Fig. 29
Gate Threshold Voltage	$V_{GS(th)}$	1.8	2.5			$V_{DS} = V_{GS}, I_{DS} = 104\text{ mA}$	Fig. 7
Zero Gate Voltage Drain Current	I_{DSS}		0.7	2	mA	$V_{GS} = 0\text{ V}, V_{DS} = 1700\text{ V}$	
			1.5	4		$V_{GS} = 0\text{ V}, V_{DS} = 1700\text{ V}, T_{VJ} = 150\text{ }^{\circ}\text{C}$	
Gate-Source Leakage Current	I_{GSS}		1	600	nA	$V_{GS} = 25\text{ V}, V_{DS} = 0\text{ V}$	
Drain-Source On-State Resistance (MOSFET Only)	$R_{DS(on)}$		8.0	10.0	m Ω	$V_{GS} = 20\text{ V}, I_D = 300\text{ A}$	Fig. 4
			16.2	20.0		$V_{GS} = 20\text{ V}, I_D = 300\text{ A}, T_{VJ} = 150\text{ }^{\circ}\text{C}$	Fig. 5 Fig. 6
Transconductance	g_{fs}		133		S	$V_{DS} = 20\text{ V}, I_D = 300\text{ A}$	Fig. 8
			131			$V_{DS} = 20\text{ V}, I_D = 300\text{ A}, T_{VJ} = 150\text{ }^{\circ}\text{C}$	
Turn-On Switching Energy	E_{On}		13.0		mJ	$V_{DD} = 900\text{ V}, I_D = 300\text{ A},$ $V_{GS} = -5\text{ V}/+20\text{ V},$ $R_{G(ON)} = 2.5\text{ }\Omega, R_{G(OFF)} = 2.5\text{ }\Omega,$ $L = 77\text{ }\mu\text{H}$ $T_{VJ} = 150\text{ }^{\circ}\text{C}$ Note: IEC 60747-8-4 Definitions	Fig. 22
Turn-Off Switching Energy	E_{Off}		10.0				
Internal Gate Resistance	$R_{G(int)}$		3.7		Ω	$f = 1\text{ MHz}, V_{AC} = 25\text{ mV}$	
Input Capacitance	C_{iss}		20		nF	$V_{DS} = 1000\text{ V}, V_{AC} = 25\text{ mV}$ $f = 200\text{ kHz}$	Fig. 16 Fig. 17
Output Capacitance	C_{oss}		2.5				
Reverse Transfer Capacitance	C_{rss}		80				
Gate to Source Charge	Q_{GS}		273		nC	$V_{DS} = 900\text{ V}, V_{GS} = -5\text{ V}/+20\text{ V},$ $I_D = 300\text{ A},$ Per JEDED24 pg 27	Fig. 15
Gate to Drain Charge	Q_{GD}		324				
Total Gate Charge	Q_G		1076				
Turn-on Delay Time	$t_{d(on)}$		105		ns	$V_{DD} = 900\text{ V}, V_{GS} = -5/+20\text{ V},$ $I_D = 300\text{ A}, R_{G(ext)} = 2.5\text{ }\Omega,$ Timing relative to V_{DS} Note: IEC 60747-8-4, pg 83 Inductive load	Fig. 23
Rise Time	t_r		72				
Turn-off Delay Time	$t_{d(off)}$		211				
Fall Time	t_f		56				
MOSFET Thermal Resistance, Junction to Case	R_{th-JCM}		0.067	0.071	$^{\circ}\text{C}/\text{W}$		Fig. 27



Diode Characteristics (Per Position) ($T_{VJ} = 25\text{ }^{\circ}\text{C}$ unless otherwise specified)

Parameter	Symbol	Min.	Typ.	Max.	Unit	Test Conditions	Notes
Body Diode Forward Voltage	V_{SD}		1.7	2.0	V	$V_{GS} = 0\text{ V}, I_{SD} = 300\text{ A}$	Fig. 10 Fig. 11
			2.2	2.5		$V_{GS} = 0\text{ V}, I_{SD} = 300\text{ A}, T_{VJ} = 150\text{ }^{\circ}\text{C}$	
Total Capacitive Charge	Q_C		4.4		μC	$I_{SD} = 300\text{ A}, V_{DS} = 900\text{ V}, T_{VJ} = 25\text{ }^{\circ}\text{C},$ $di_{SD}/dt = 9\text{ kA}/\mu\text{s}, V_{GS} = -5\text{ V}$	
DIODE Thermal Resistance, Junction to Case	R_{th-JCD}		0.060	0.065	$^{\circ}\text{C}/\text{W}$		Fig. 28

Module Physical Characteristics

Parameter	Symbol	Min.	Typ.	Max.	Unit	Test Conditions
Stray Inductance	L_{Stray}		15		nH	Between terminals 2 & 3
Case Temperature	T_C	-40		125	$^{\circ}\text{C}$	
Mounting Torque	M_S		5.0		N-m	To heatsink and terminals
Weight	W		300		g	
Case Isolation Voltage	V_{isol}	5.0			kV	AC, 50 Hz, 1 minute
Clearance Distance		9			mm	Terminal to terminal
Creepage Distance		30				Terminal to terminal
		40				Terminal to baseplate



Typical Performance

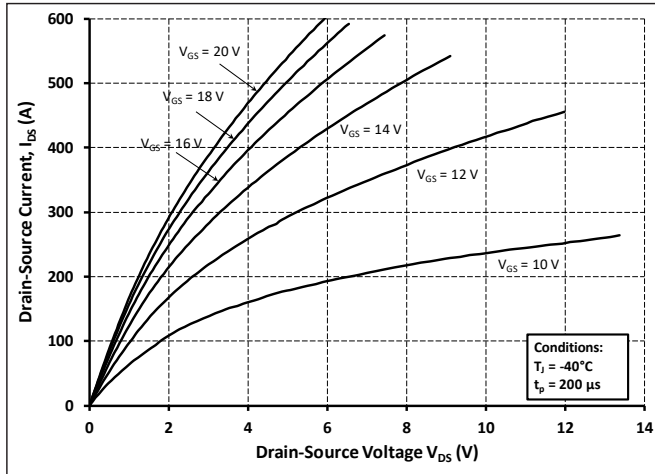

Figure 1. Output Characteristics for $T_{VJ} = 40\text{ }^{\circ}\text{C}$

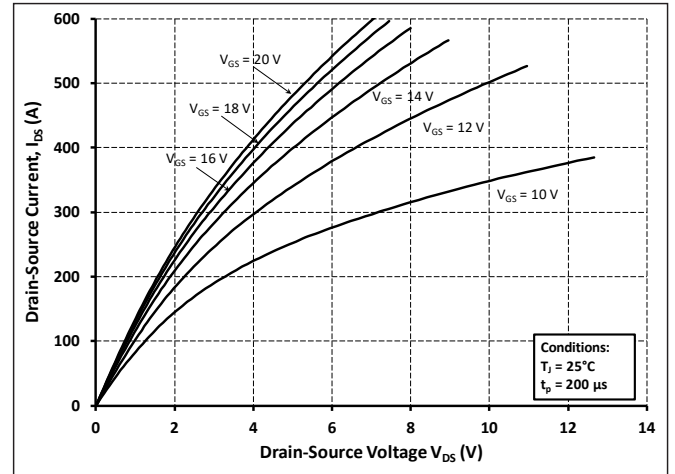

Figure 2. Output Characteristics for $T_{VJ} = 25\text{ }^{\circ}\text{C}$

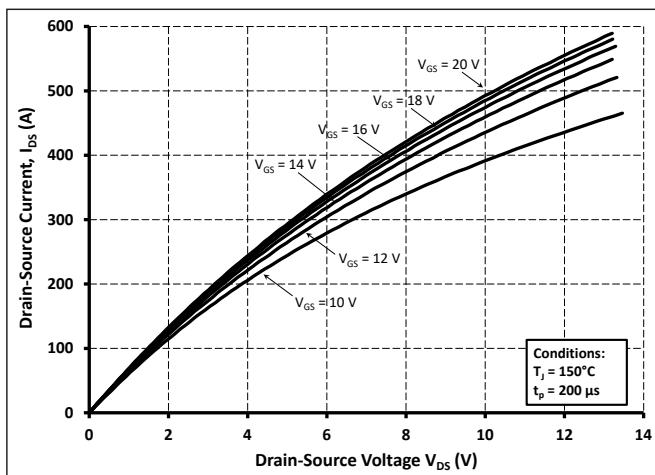

Figure 3. Output Characteristics for $T_{VJ} = 150\text{ }^{\circ}\text{C}$

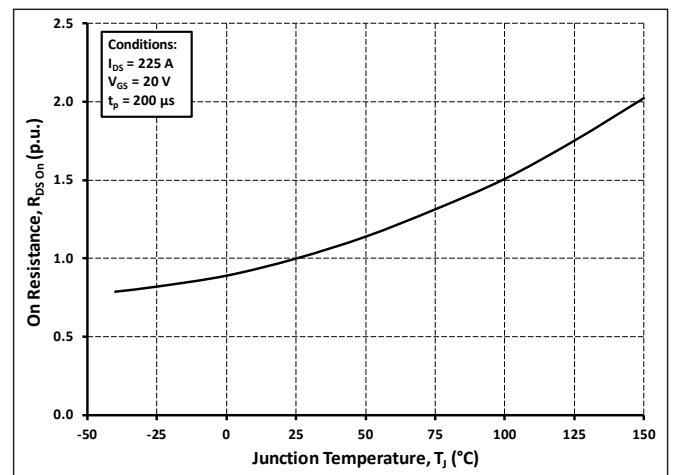

Figure 4. Normalized On-Resistance vs. Temperature

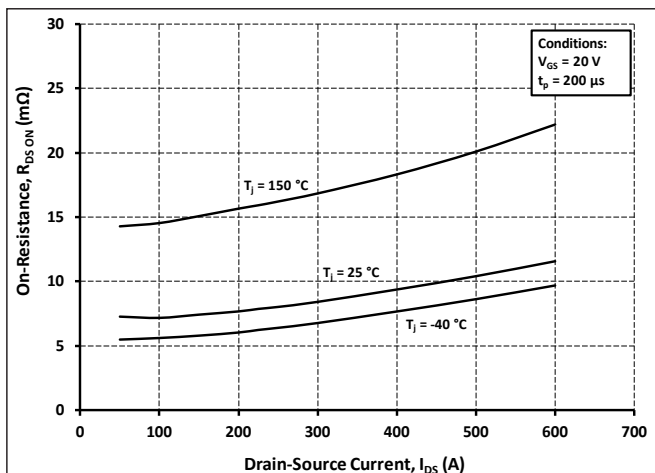

Figure 5. On-Resistance vs. Drain Current For Various Temperatures

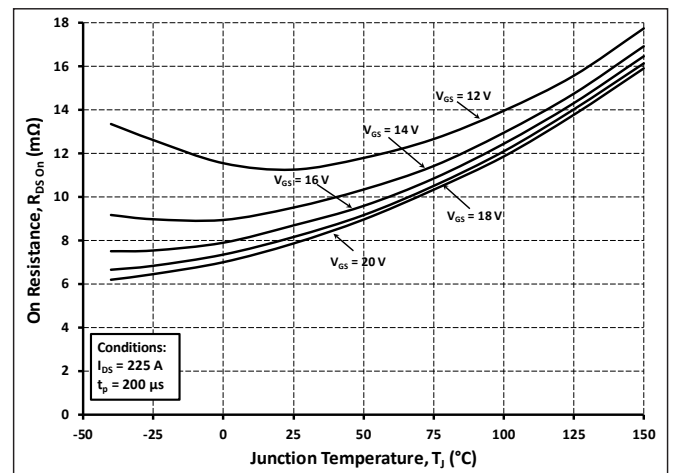

Figure 6. On-Resistance vs. Temperature for Various Gate-Source Voltage



Typical Performance

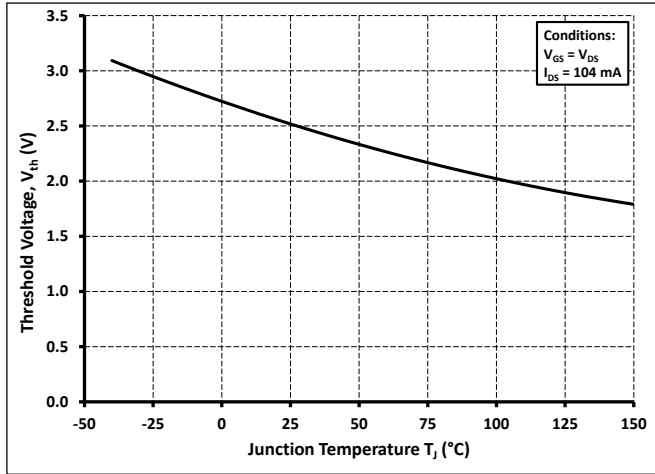

Figure 7. Threshold Voltage vs. Temperature

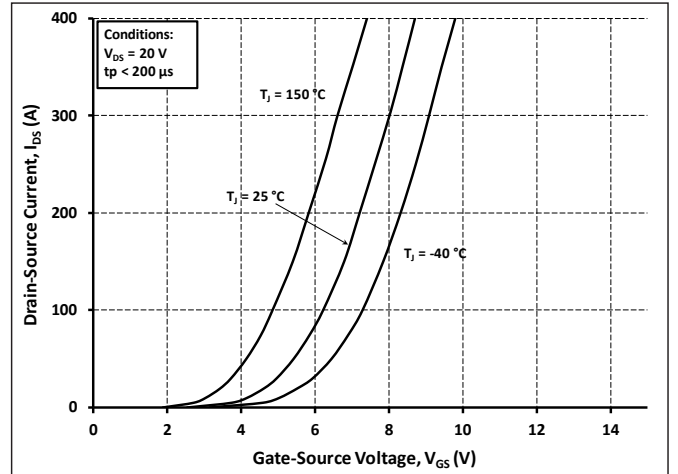

Figure 8. Transfer Characteristic for Various Junction Temperatures

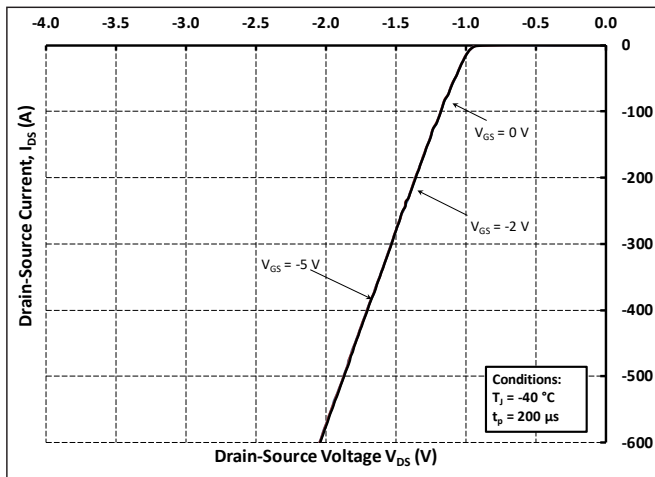

Figure 9. Diode Characteristic at $T_{vj} = -40\text{ }^{\circ}\text{C}$

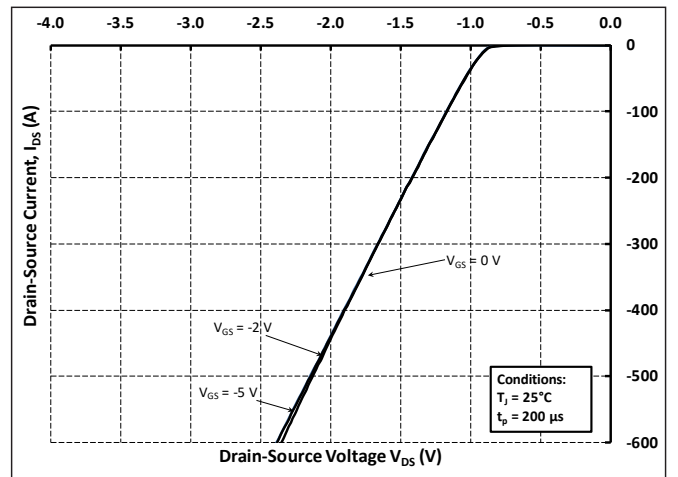

Figure 10. Diode Characteristic at $T_{vj} = 25\text{ }^{\circ}\text{C}$

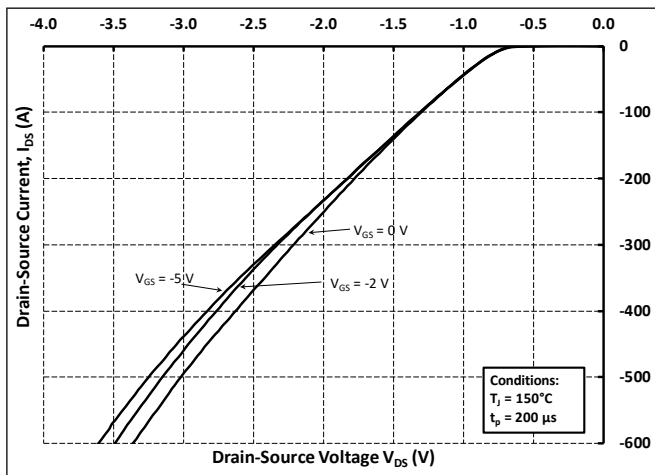

Figure 11. Diode Characteristic at $T_{vj} = 150\text{ }^{\circ}\text{C}$

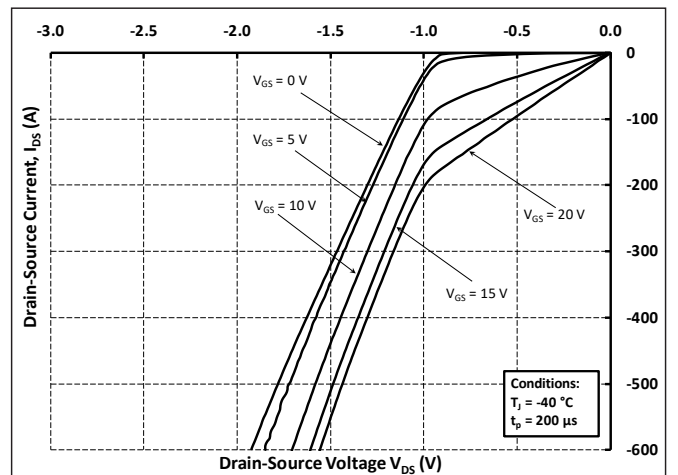

Figure 12. 3rd Quadrant Characteristic at $T_{vj} = -40\text{ }^{\circ}\text{C}$



Typical Performance

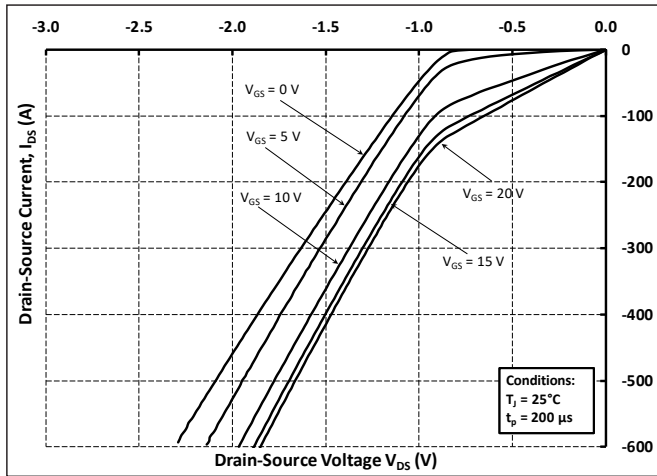

Figure 13. 3rd Quadrant Characteristic at $T_{VJ} = 25\text{ }^{\circ}\text{C}$

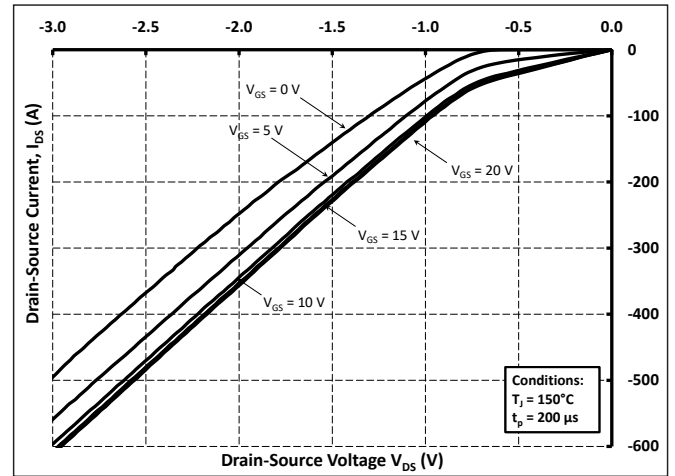

Figure 14. 3rd Quadrant Characteristic at $T_{VJ} = 150\text{ }^{\circ}\text{C}$

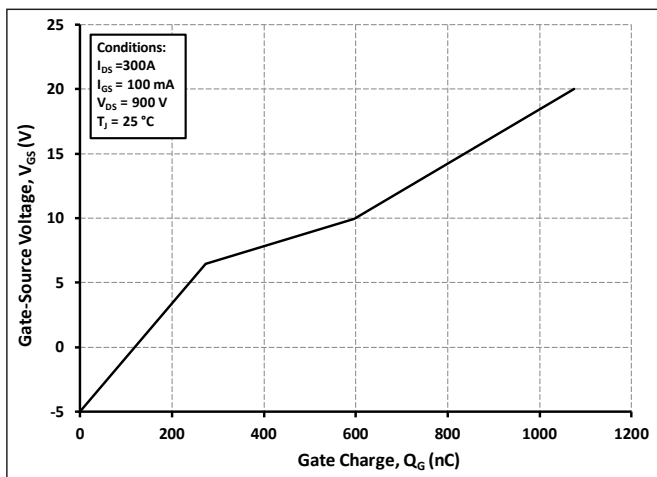

Figure 15. Gate Charge Characteristics

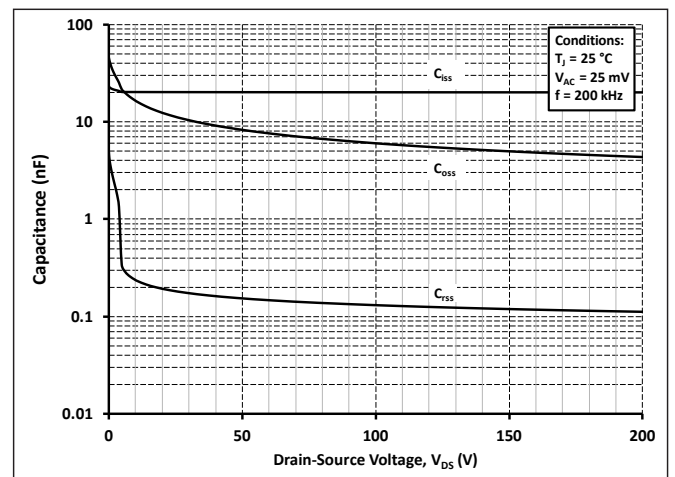

Figure 16. Capacitances vs. Drain-Source Voltage (0 - 200 V)

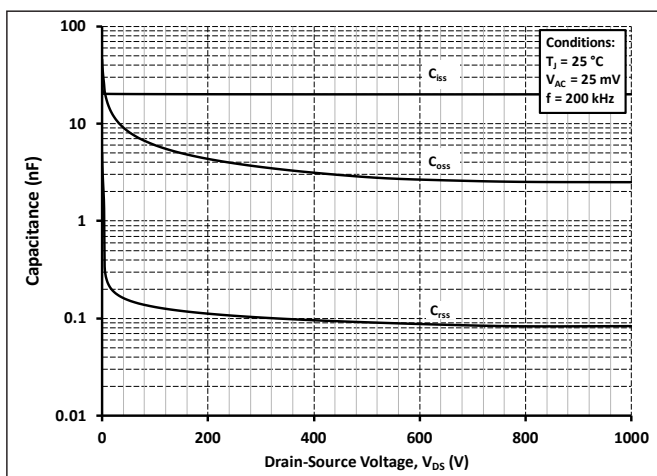

Figure 17. Capacitances vs. Drain-Source Voltage (0 - 1 kV)

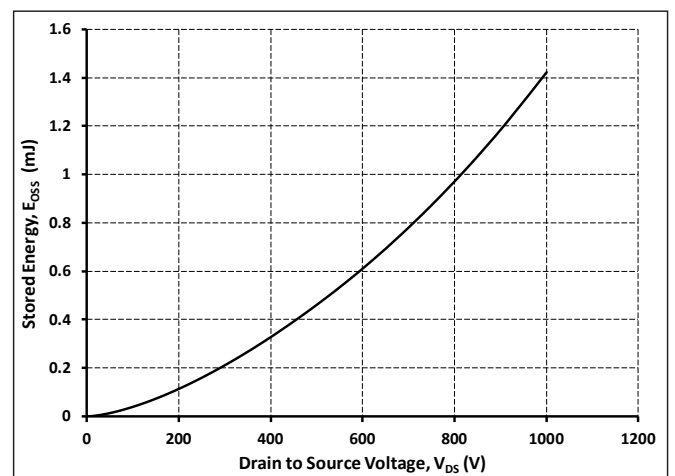

Figure 18. Output Capacitor Stored Energy



Typical Performance

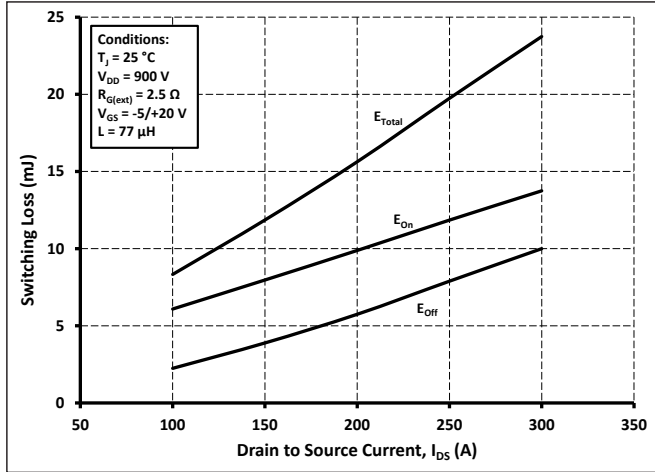

Figure 19. Inductive Switching Energy vs. Drain Current For $V_{DS} = 900\text{ V}$, $R_G = 2.5\ \Omega$

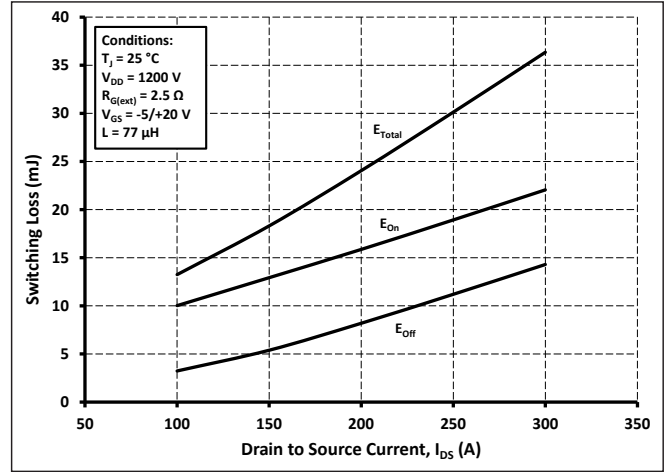

Figure 20. Inductive Switching Energy vs. Drain Current For $V_{DS} = 1200\text{ V}$, $R_G = 2.5\ \Omega$

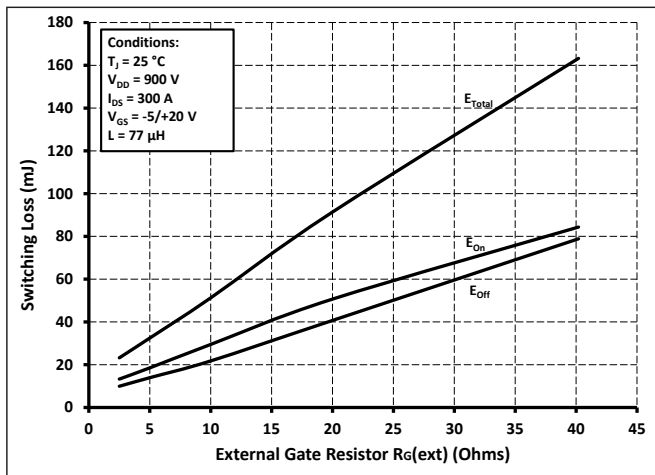

Figure 21. Inductive Switching Energy vs. $R_{G(ext)}$

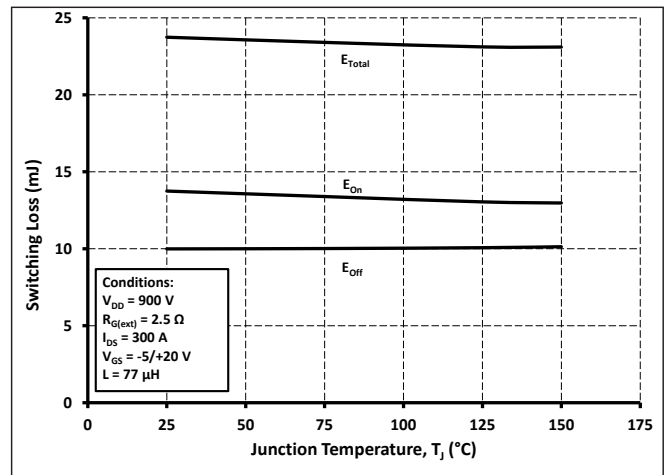

Figure 22. Inductive Switching Energy vs. Temperature

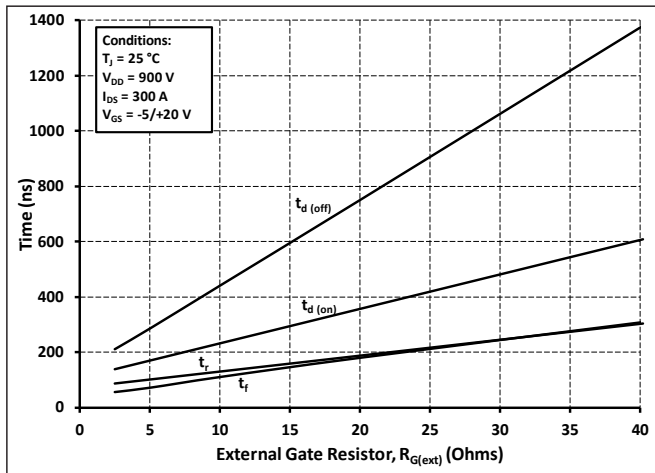

Figure 23. Timing vs. $R_{G(ext)}$

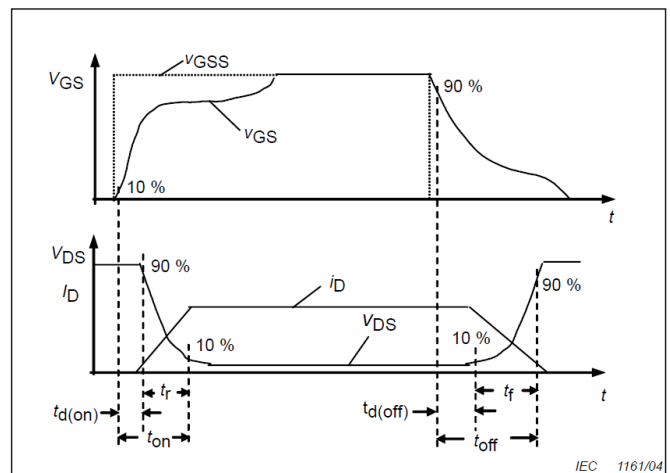

Figure 24. Resistive Switching Time Description



Timing Characteristics

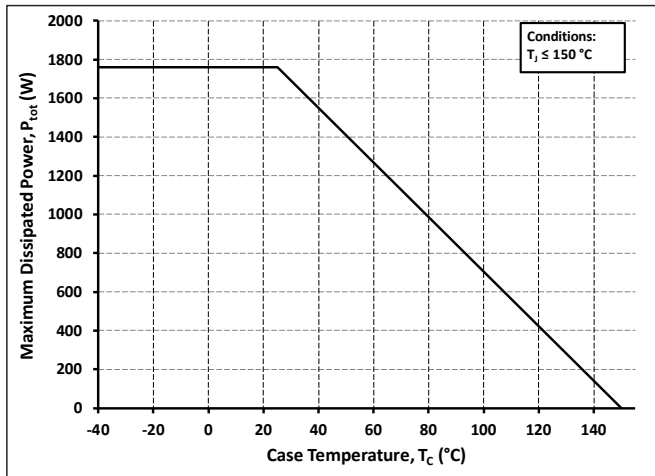

Figure 25. Maximum Power Dissipation (MOSFET) Derating vs. Case Temperature

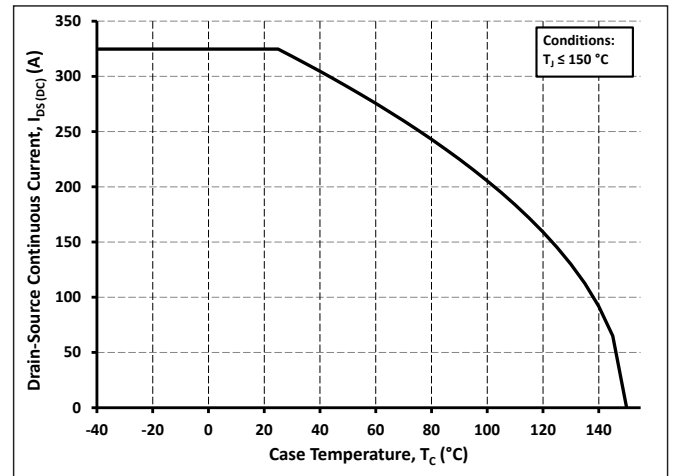

Figure 26. Continuous Drain Current Derating vs Case Temperature

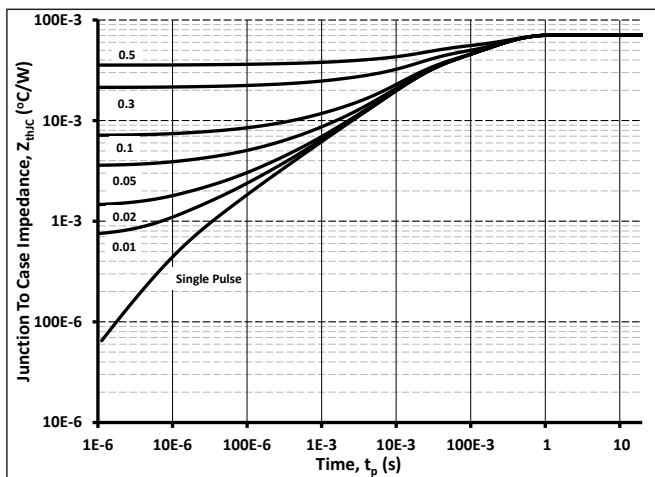

Figure 27. MOSFET Junction to Case Thermal Impedance

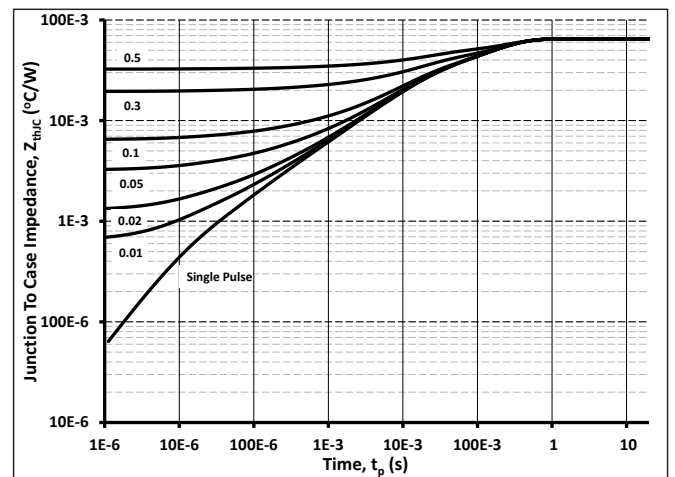

Figure 28. Diode Junction to Case Thermal Impedance

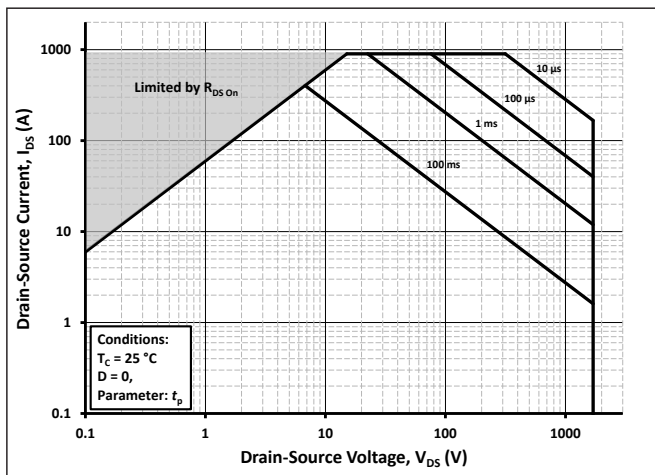
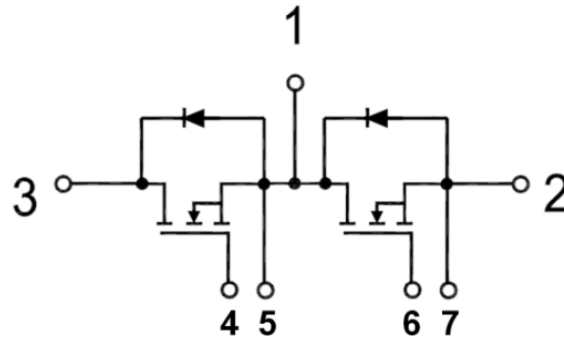

Figure 29. Safe Operating Area



Schematic



Package Dimension (mm)

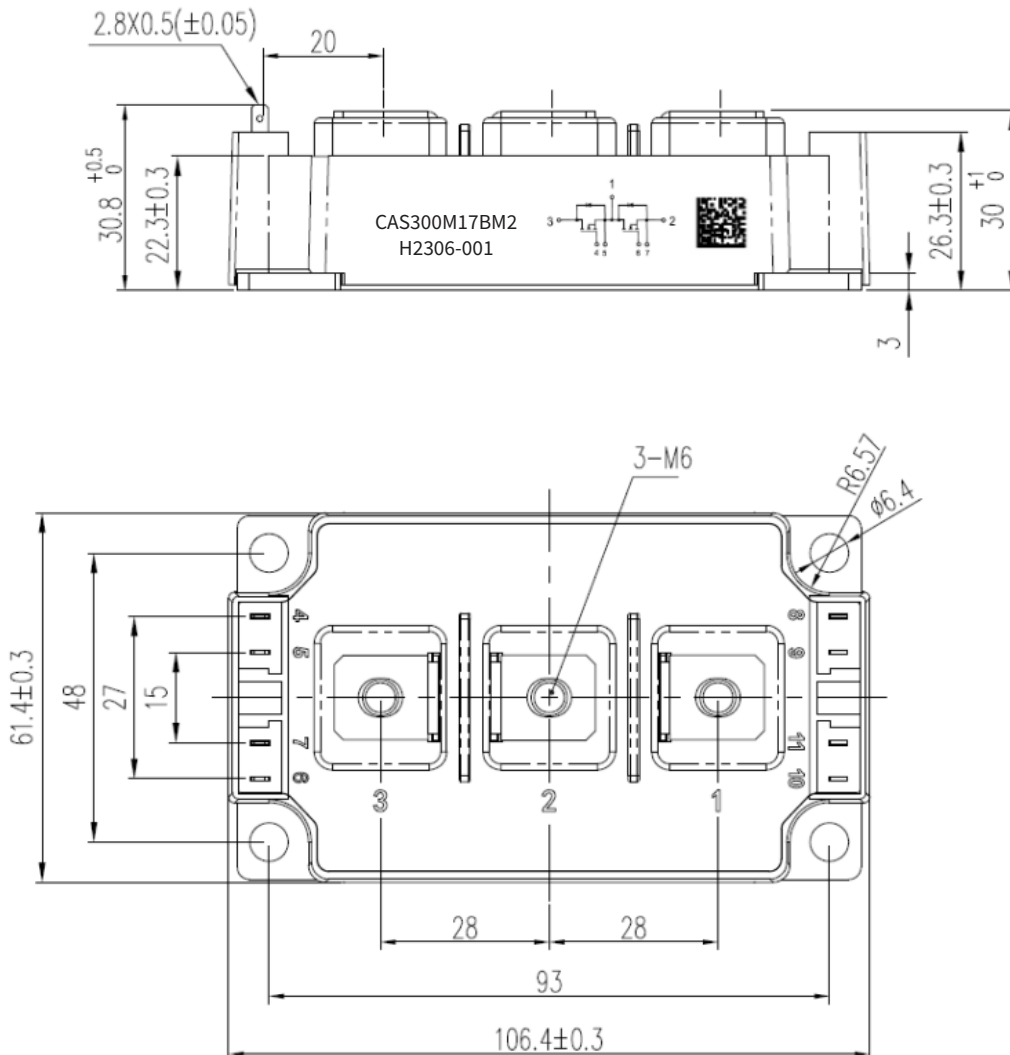



Supporting Links & Tools

Evaluation Tools & Support

- [KIT-CRD-CIL17N-BM](#): Dynamic Performance Evaluation Board for the 62 mm Module
- [SpeedFit 2.0 Design Simulator™](#)
- [Technical Support Forum](#)

Dual-Channel Gate Driver Board

- [CGD1700HB2P-BM2](#): Dual Channel Differential Isolated Half Bridge Gate Driver Board
- [CGD12HB00D](#): Differential Transceiver Daughter Board Companion Tool for Differential Gate Drivers

Application Notes

- [62 mm Module Mounting Guide](#)
- [62 mm Module Thermal Interface Material Guide](#)



Notes & Disclaimer

This document and the information contained herein are subject to change without notice. Any such change shall be evidenced by the publication of an updated version of this document by Cree. No communication from any employee or agent of Cree or any third party shall effect an amendment or modification of this document. No responsibility is assumed by Cree for any infringement of patents or other rights of third parties which may result from use of the information contained herein. No license is granted by implication or otherwise under any patent or patent rights of Cree.

Notwithstanding any application-specific information, guidance, assistance, or support that Cree may provide, the buyer of this product is solely responsible for determining the suitability of this product for the buyer's purposes, including without limitation for use in the applications identified in the next bullet point, and for the compliance of the buyers' products, including those that incorporate this product, with all applicable legal, regulatory, and safety-related requirements.

This product has not been designed or tested for use in, and is not intended for use in, applications in which failure of the product would reasonably be expected to cause death, personal injury, or property damage, including but not limited to equipment implanted into the human body, life-support machines, cardiac defibrillators, and similar emergency medical equipment, aircraft navigation, communication, and control systems, aircraft power and propulsion systems, air traffic control systems, and equipment used in the planning, construction, maintenance, or operation of nuclear facilities.

RoHS Compliance

The levels of RoHS restricted materials in this product are below the maximum concentration values (also referred to as the threshold limits) permitted for such substances, or are used in an exempted application, in accordance with EU Directive 2011/65/EC (RoHS2), as implemented January 2, 2013. RoHS Declarations for this product can be obtained from your Cree representative or from the Product Documentation sections of www.cree.com.

REACH Compliance

REACH substances of high concern (SVHCs) information is available for this product. Since the European Chemical Agency (ECHA) has published notice of their intent to frequently revise the SVHC listing for the foreseeable future, please contact your Cree representative to ensure you get the most up-to-date REACH SVHC Declaration. REACH banned substance information (REACH Article 67) is also available upon request.

Contact info:

4600 Silicon Drive
Durham, NC 27703 USA
Tel: +1.919.313.5300
www.wolfspeed.com/power