

CBM-90-IRD - 780nm

Infrared Chip On Board LEDs

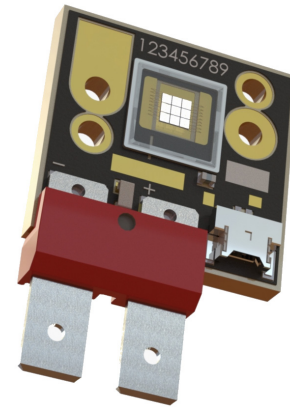

Table of Contents

Technology Overview	2
Product Binning.	3
Ordering Information	4
Optical and Electrical Characteristics	5
Mech. Dimensions	9
Tray Information	10
Shipping information	11
Revision History.	12

Features

- High Power Infrared LED with surface emitting area of 10.63 mm²
- Dual-junction chip technology for maximum optical coupling in etendue-limited systems
- Common anode copper chip-on board package with high precision optical alignment features
- Low thermal resistance: 0.6°C/W junction to case
- Can be operated at variable drive currents up to 18A DC and 22.5A Pulse.
- Complements Luminus extensive CBT/CFT-90 series ranging from 405 nm to 940 nm for medical, instrumentation and industrial fiber-coupled illumination

Applications

- Medical and Scientific Instrumentation
- Fiber-coupled illumination
- Inspection
- Machine Vision
- Laser source replacement for applications where light coherence is not necessary.

Technology Overview

Luminus CBM-90-IRD LEDs benefit from innovations in device technology, chip packaging and thermal management. This suite of technologies give engineers and system designers the freedom to develop solutions both high in power and efficiency.

Reliability

Luminus CBM-90-IRD LEDs have passed a rigorous suite of environmental tests such as high-temperature operating life (HTOL), temperature cycling (TC) and humidity (WHTOL). They are fully qualified for use in a wide range of high performance and high efficacy applications.

REACH & RoHS Compliance

The Luminus CBM-90-IRD LED is compliant to the Restriction of Hazardous Substances Directive or RoHS. The restricted materials including lead, mercury, cadmium, hexavalent chromium, polybrominated biphenyls (PBB) and polybrominated diphenyl ether (PBDE) are not used.

Understanding Luminus CBM-90-IRD LED Test Specifications

Every Luminus LED is fully tested to ensure it meets the high quality standards customers have come to expect from Luminus products.

Testing Temperature

Luminus CBM-90-IRD LEDs are tested and binned at 40°C heatsink temperature. Temperature curves are provided to allow users to scale the data for actual operating temperature conditions.

CBM-90-IRD Binning Structure

All CBM-90-IRD LEDs are tested for radiometric power / peak wavelength and placed into one of the following flux / wavelength bins.

Flux Bins¹

Bin Code	Radiometric Power at 13.5A, $t_p=20ms$	
	Minimum Flux (W)	Maximum Flux (W)
J	7	7.75
K	7.75	8.5
L	8.5	9.25
M	9.25	10
N	10	10.75
P	10.75	11.5
Q	11.5	12.25

Note 1: Luminus maintains a +/-6% tolerance in flux measurements.

Wavelength Bins

Bin Code	Minimum Peak Wavelength (nm)	Maximum Peak Wavelength (nm)
770	770	772.5
773	772.5	775
775	775	777.5
778	777.5	780
780	780	782.5
783	782.5	785
785	785	787.5
788	787.5	790

Product Ordering and Shipping Part Number Nomenclature

All CBM-90-IRD products are packaged and labeled with part numbers as outlined in below. The part number designation is as follows:

CBM – **90** – **IRD** – **X33** – **F###-##**

Product Family	Chip Area	Color	Package Configuration	Bin Kit
CBM: Copper-core PCB, Multi Chip Array, AR-coated protective window	90: 9 mm ²	IRD = Dual junction Infrared	X33: 28 mm x 26.75 mm - Common Anode Package See Mechanical Drawing section	See below for flux and wavelength binning information

Part Number	Minimum Flux Bin (W)	Minimum PWL (nm)	PWL range (nm)	Ordering Part Number
CBM-90-IRD-X33	J	770	20	<i>CBM-90-IRD-X33-J770-20</i>

Optical and Electrical Characteristics

Optical and Electrical Characteristics¹

Parameter	Symbol	Value	Unit
Forward Current at Test	I_f	13.5	A
Minimum Forward Voltage ¹	V_{fmin}	3.0	V
Forward Voltage Typical	V_f	3.6	V
Maximum Forward Voltage ¹	V_{fmax}	4.0	V
Viewing Angle	$2\theta_{1/2}$	120	deg
Peak Wavelength Typical	λ_p	780	nm
Centroid Wavelength Typical	λ_c	775	nm
FWHM Typical	$\Delta\lambda_{1/2}$	30	nm
Temperature Coefficient of Forward voltage	TC_{Vf}	-2	mV/°C
Temperature Coefficient of Radiometric Power	TC_{PO}	-0.45	%/°C
Temperature Coefficient of Wavelength	TC_{λ}	0.2	nm/°C
Thermal Resistance (Electrical) ²	$R_{th(i-b)}$	0.45	°C/W
Emitting Area		10.63	mm ²
Emitting Area Dimensions		3.3 x 3.3	mm ²

Note 1: Parts are tested and binned at a current of 13.5A, 20ms single pulse and a constant heatsink temperature of $T_{hs} = 40^\circ\text{C}$.

Note 2: Thermal resistance between junction to board (case).

Optical and Electrical Characteristics

Absolute Ratings^{2,5}

Parameter	Symbol	Rating	Unit
Absolute Minimum Current (CW or pulse) ^{3,4}		0.2	A
Absolute Maximum Current (CW) ^{3,4}		18.0	A
Reverse Voltage	V _R	5	V
Storage Temperature	T _{STG}	-40~100	°C
Maximum Junction Temperature ^{3,4}	T _{jmax}	115 °C	°C

Note 2: To prevent damage refer to operating conditions and derating curves for appropriate maximum operating conditions

Note 3: Luminus CBM-90-IRD LEDs are designed for operation up to an absolute maximum forward drive current as specified above. Product lifetime data is specified at typical forward drive currents. Sustained operation at absolute maximum currents will result in a reduction of device lifetime compared to typical forward drive currents. Actual device lifetimes will also depend on junction temperature.

Note 4: Maximum operating case temperature combined with maximum drive current defines the total maximum operating condition for the device. To prevent damage, please operate devices within specified conditions.

Note 5: Caution must be taken not to stare at the light emitted from these LEDs. Under special circumstances, the high intensity could damage the eye.

Optical and Electrical Characteristics

Relative Radiometric Power vs. Forward Current

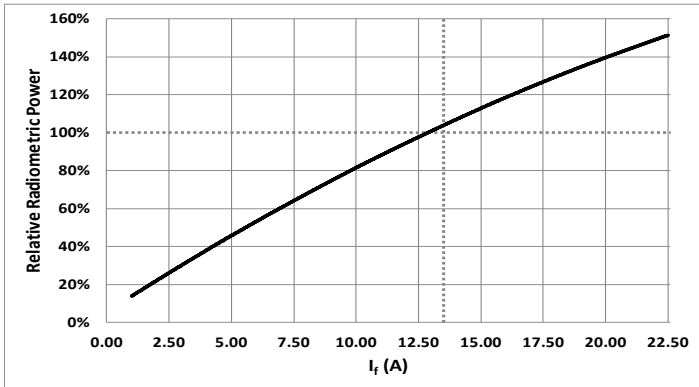

Relative Radiometric Power vs. Temperature

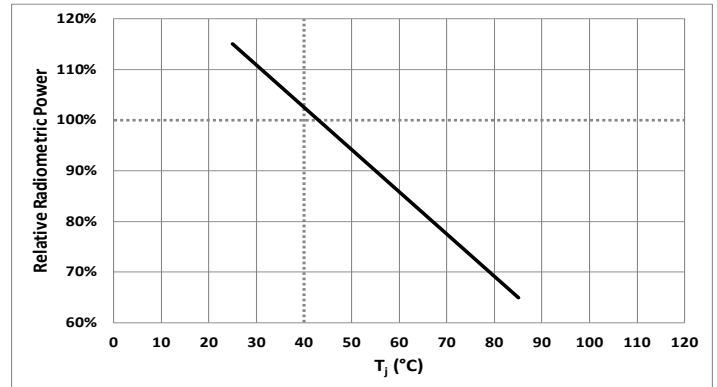

Relative Voltage vs. Forward Current

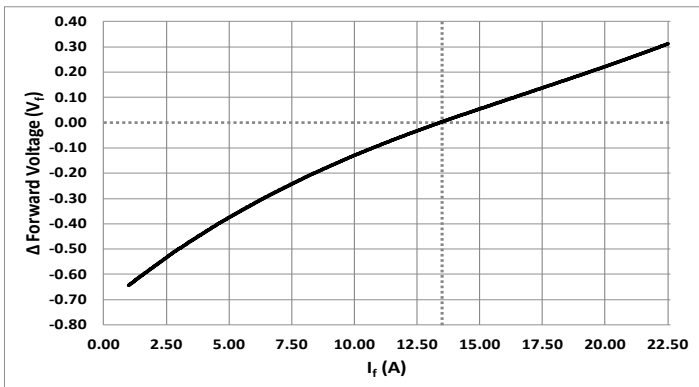

Relative Voltage vs. Temperature

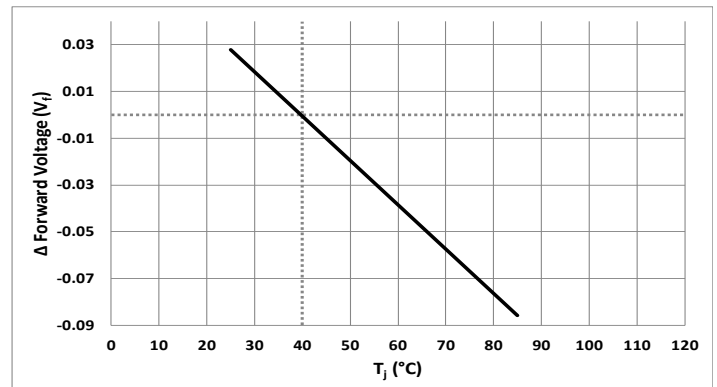

Relative Centroid Wavelength vs. Forward Current

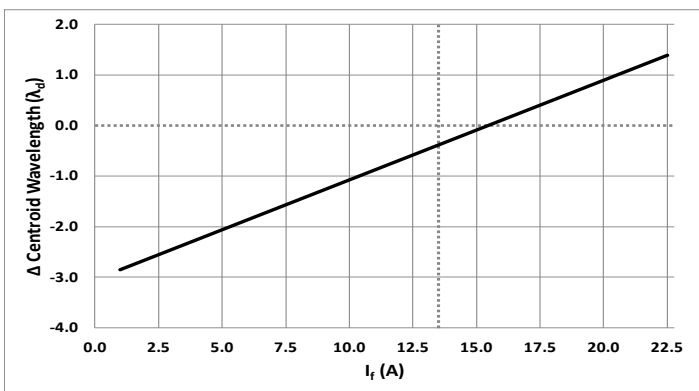

Relative Centroid Wavelength vs. Temperature

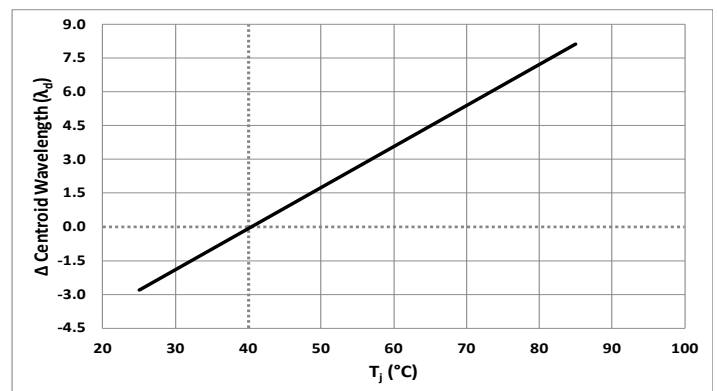

Optical and Electrical Characteristics

Relative Peak Wavelength vs. Forward Current

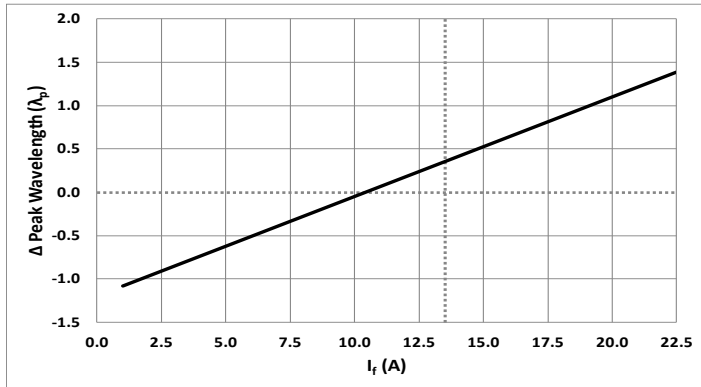

Relative Peak Wavelength vs. Temperature

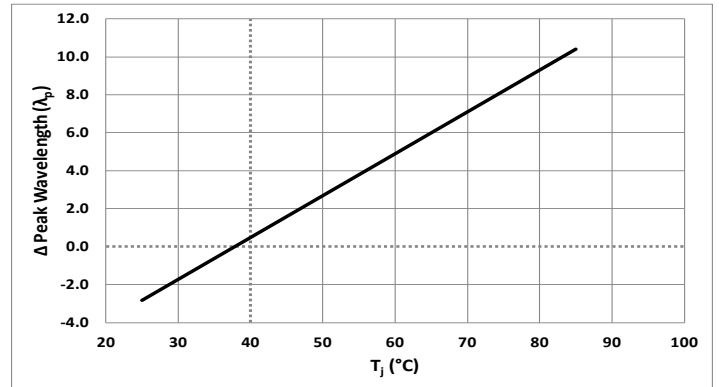

Angular Distribution

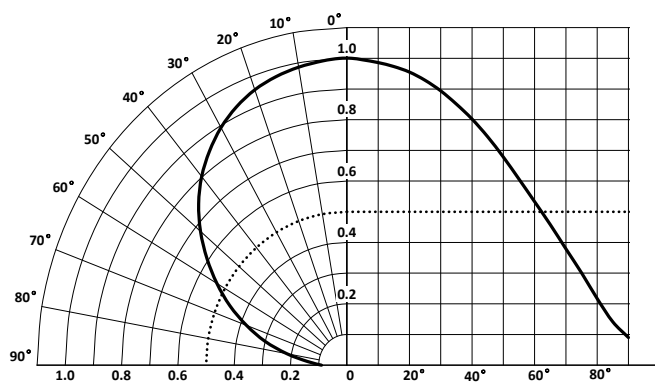

Typical Spectra

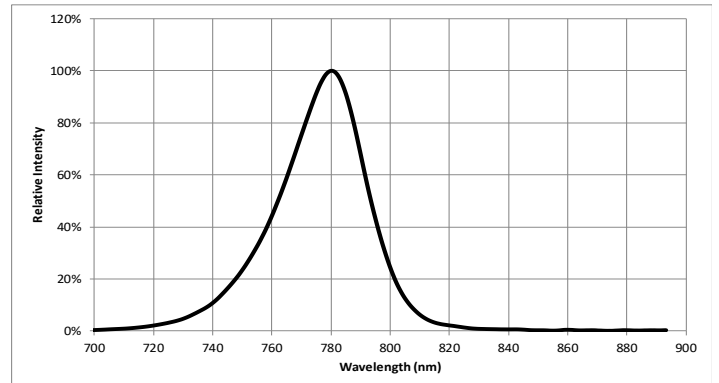

Mechanical Dimensions

DIMENSIONS IN MILLIMETERS

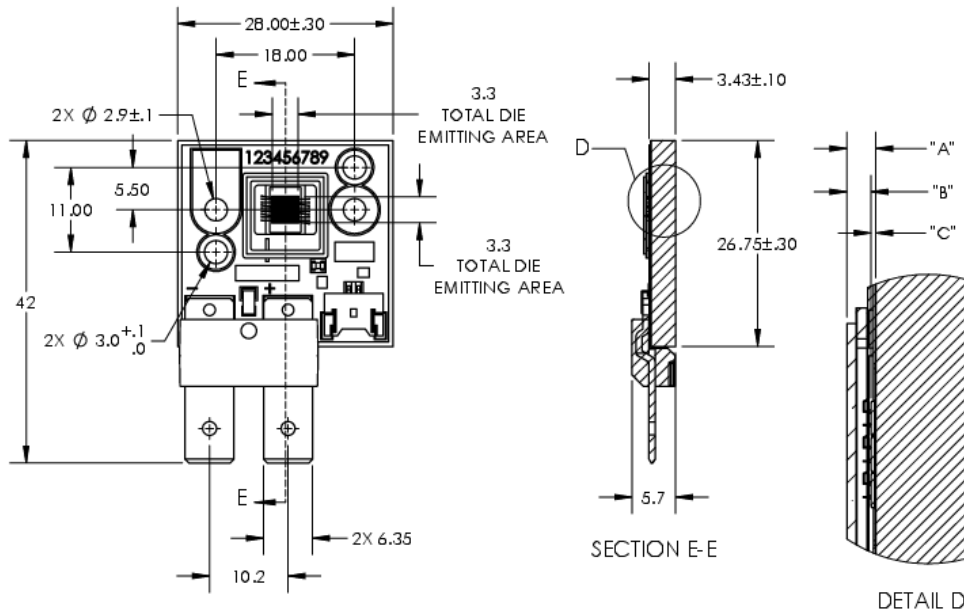
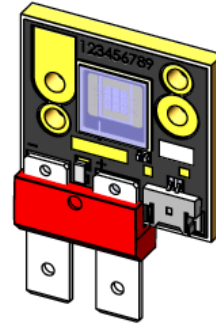

DIMENSION NAME	DESCRIPTION	NOMINAL DIMENSION	TOLERANCE
"A"	TOP OF METAL SUBSTRATE TO TOP OF WINDOW	.93	$\pm .13$
"B"	TOP OF DIE EMITTING AREA TO TOP OF WINDOW	.79	$\pm .13$
"C"	TOP OF METAL SUBSTRATE TO TOP OF DIE EMITTING AREA	.14	$\pm .02$

DWG-003067 REV01

Recommended connector for Anode and Cathode:

Panduit Disco Lok™ Series P/N: DNF14-250FIB-C or JST Manufacturing Co: SPS-61T-250 for AWG 16 to 14.

Panduit Disco Lok™ Series P/N: DNF10-250FIB-L or JST Manufacturing Co: SPS-91T-250 for AWG 12 to 10.

(Check NEC standards for ampacity of the power cable being used.)

Thermistor Connector: GCT P/N WTB08-021S-F.

Recommended Female: MOLEX P/N 51146-0200 (Not recommended for new designs), GCT P/N WTB06-020H-A or equivalent.

Shipping Tray Outline

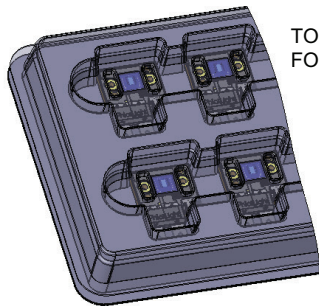
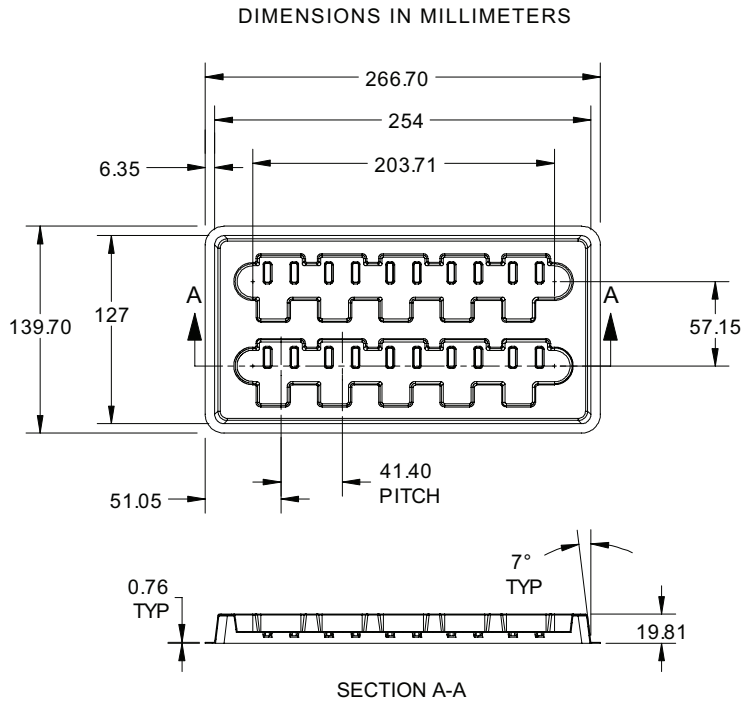

TOP TRAY SHOWN TRANSPARENT
FOR REFERENCE ONLY

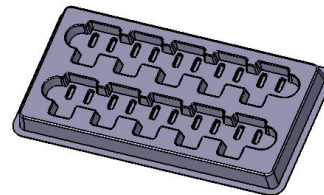

Packing and Shipping Specification (CBM-90-IRD)

Packing Specification

Packing Configuration	Qty /Pack	Packing Dimensions (diameter x W, mm)	Gross Weight (kg)
Stack of 5 trays with 10 devices per tray Each pack is enclosed in ESD bag	50	150 x 280 x 85	2.7

Product Label Specification

Label Fields (subject to change):

- 6-8 digit Box number (for Luminus internal use)
- Luminus ordering part number
- Quantity of devices in pack
- Part number revision (for Luminus internal use)
- Customer's part number (optional)
- Bin (FF-WW) as defined page 3
- 2D Bar code





LUMINUS
LEADER IN BIG CHIP LEDS Solid State Filament™

BT-012345

Box number

PT-120-G-L11-MPG

Luminus part number

12345678

Customer part number

5F

Bin

Qty: 50

Rev 01



for traceability peel off label and attach

RoHS Compliant

Sample label –for illustration only

Shipping Box

Shipping Box	Quantity	Material	Dimensions (L x W x H, mm)
Carton Box	1 -20 packs (50 - 1000 Devices)	S4651	560 x 560 x 200



History of Changes

Rev	Date	Description of Change
01	10/29/2018	Preliminary Release
02	10/14/2019	Changed product name to CBM-90-IRD-780nm on pages 1 and 4 Updated PWL bins (page 3) and typical PWL and centroid values (table on page 5)
03	10/28/2019	Updated power bin following recalibration
04	05/05/2020	Updated picture on front page, ordering information on page 3, binning structure on page 4, added graphs on pages 7-8 and revised presentation drawing on page 9
05	08/10/2020	Updated temperature coefficient of radiometric power and thermal resistance on page 5

The products, their specifications and other information appearing in this document are subject to change by Luminus Devices without notice. Luminus Devices assumes no liability for errors that may appear in this document, and no liability otherwise arising from the application or use of the product or information contained herein. None of the information provided herein should be considered to be a representation of the fitness or suitability of the product for any particular application or as any other form of warranty. Luminus Devices' product warranties are limited to only such warranties as accompany a purchase contract or purchase order for such products. Nothing herein is to be construed as constituting an additional warranty. No information contained in this publication may be considered as a waiver by Luminus Devices of any intellectual property rights that Luminus Devices may have in such information. Big Chip LEDs™ is a registered trademark of Luminus Devices, Inc., all rights reserved.

This product is protected by U.S. Patents 6,831,302; 7,074,631; 7,083,993; 7,084,434; 7,098,589; 7,105,861; 7,138,666; 7,166,870; 7,166,871; 7,170,100; 7,196,354; 7,211,831; 7,262,550; 7,274,043; 7,301,271; 7,341,880; 7,344,903; 7,345,416; 7,348,603; 7,388,233; 7,391,059 Patents Pending in the U.S. and other countries.