

# NIF5003N

Preferred Device

## Self-Protected FET with Temperature and Current Limit

42 V, 14 A, Single N-Channel, SOT-223

HDPlus™ devices are an advanced series of power MOSFETs which utilize ON Semiconductors latest MOSFET technology process to achieve the lowest possible on-resistance per silicon area while incorporating smart features. Integrated thermal and current limits work together to provide short circuit protection. The devices feature an integrated Drain-to-Gate Clamp that enables them to withstand high energy in the avalanche mode. The Clamp also provides additional safety margin against unexpected voltage transients. Electrostatic Discharge (ESD) protection is provided by an integrated Gate-to-Source Clamp.

### Features

- Short Circuit Protection/Current Limit
- Thermal Shutdown with Automatic Restart
- $I_{DSS}$  Specified at Elevated Temperature
- Avalanche Energy Specified
- Slew Rate Control for Low Noise Switching
- Overvoltage Clamped Protection
- Pb-Free Packages are Available

### MAXIMUM RATINGS ( $T_J = 25^\circ\text{C}$ unless otherwise noted)

Rating	Symbol	Value	Unit
Drain-to-Source Voltage Internally Clamped	$V_{DSS}$	42	Vdc
Gate-to-Source Voltage	$V_{GS}$	$\pm 14$	Vdc
Drain Current Continuous	$I_D$	Internally Limited	
Total Power Dissipation @ $T_A = 25^\circ\text{C}$ (Note 1) @ $T_A = 25^\circ\text{C}$ (Note 2)	$P_D$	1.25 1.9	W
Thermal Resistance Junction-to-Case Junction-to-Ambient (Note 1) Junction-to-Ambient (Note 2)	$R_{\theta JC}$ $R_{\theta JA}$ $R_{\theta JA}$	12 100 65	$^\circ\text{C}/\text{W}$
Single Pulse Drain-to-Source Avalanche Energy ( $V_{DD} = 25 \text{ Vdc}$ , $V_{GS} = 5.0 \text{ Vdc}$ , $I_L = 7.0 \text{ Apk}$ , $L = 9.5 \text{ mH}$ , $R_G = 25 \Omega$ )	$E_{AS}$	233	mJ
Operating and Storage Temperature Range (Note 3)	$T_J, T_{stg}$	-55 to 150	$^\circ\text{C}$

Stresses exceeding Maximum Ratings may damage the device. Maximum Ratings are stress ratings only. Functional operation above the Recommended Operating Conditions is not implied. Extended exposure to stresses above the Recommended Operating Conditions may affect device reliability.

1. Surface mounted onto minimum pad size (0.412" square) FR4 PCB, 1 oz cu.
2. Mounted onto 1" square pad size (1.127" square) FR4 PCB, 1 oz cu.
3. Normal pre-fault operating range. See thermal limit range conditions.



ON Semiconductor®

<http://onsemi.com>

$V_{DSS}$ (Clamped)	$R_{DS(on)}$ TYP	$I_D$ MAX (Limited)
42 V	53 m $\Omega$ @ 10 V	14 A

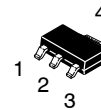
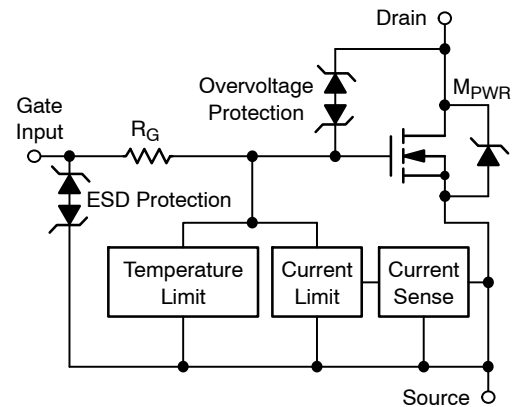

SOT-223  
CASE 318E  
STYLE 3

### MARKING DIAGRAM

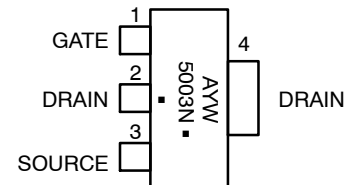

A = Assembly Location  
Y = Year  
W = Work Week  
5003N = Specific Device Code  
▪ = Pb-Free Package  
(Note: Microdot may be in either location)

### ORDERING INFORMATION

See detailed ordering and shipping information in the package dimensions section on page 4 of this data sheet.

Preferred devices are recommended choices for future use and best overall value.

# NIF5003N

## MOSFET ELECTRICAL CHARACTERISTICS (T<sub>J</sub> = 25°C unless otherwise noted)

Characteristic	Symbol	Min	Typ	Max	Unit
----------------	--------	-----	-----	-----	------

### OFF CHARACTERISTICS

Drain-to-Source Clamped Breakdown Voltage (V <sub>GS</sub> = 0 Vdc, I <sub>D</sub> = 250 μAdc) (V <sub>GS</sub> = 0 Vdc, I <sub>D</sub> = 250 μAdc, T <sub>J</sub> = -40°C to 150°C)	V <sub>(BR)DSS</sub>	42 40	46 45	51 51	Vdc mV/°C
Zero Gate Voltage Drain Current (V <sub>DS</sub> = 32 Vdc, V <sub>GS</sub> = 0 Vdc) (V <sub>DS</sub> = 32 Vdc, V <sub>GS</sub> = 0 Vdc, T <sub>J</sub> = 150°C)	I <sub>DSS</sub>	- -	0.6 2.5	5.0 -	μAdc
Gate Input Current (V <sub>GS</sub> = 5.0 Vdc, V <sub>DS</sub> = 0 Vdc)	I <sub>GSS</sub>	-	50	125	μAdc

### ON CHARACTERISTICS

Gate Threshold Voltage (V <sub>DS</sub> = V <sub>GS</sub> , I <sub>D</sub> = 1.2 mAdc) Threshold Temperature Coefficient (Negative)	V <sub>GS(th)</sub>	1.0 -	1.7 5.0	2.2 -	Vdc mV/°C
Static Drain-to-Source On-Resistance (Note 4) (V <sub>GS</sub> = 10 Vdc, I <sub>D</sub> = 3.0 Adc, T <sub>J</sub> @ 25°C) (V <sub>GS</sub> = 10 Vdc, I <sub>D</sub> = 3.0 Adc, T <sub>J</sub> @ 150°C)	R <sub>DS(on)</sub>	- -	53 95	68 123	mΩ
Static Drain-to-Source On-Resistance (Note 4) (V <sub>GS</sub> = 5.0 Vdc, I <sub>D</sub> = 3.0 Adc, T <sub>J</sub> @ 25°C) (V <sub>GS</sub> = 5.0 Vdc, I <sub>D</sub> = 3.0 Adc, T <sub>J</sub> @ 150°C)	R <sub>DS(on)</sub>	- -	63 105	76 135	mΩ
Source-Drain Forward On Voltage (I <sub>S</sub> = 7.0 A, V <sub>GS</sub> = 0 V)	V <sub>SD</sub>	-	0.95	1.1	V

### SWITCHING CHARACTERISTICS

Turn-on Time (V <sub>in</sub> to 90% I <sub>D</sub> )	R <sub>L</sub> = 4.7 Ω, V <sub>in</sub> = 0 to 10 V, V <sub>DD</sub> = 12 V	T <sub>(on)</sub>	-	16	20	μs
Turn-off Time (V <sub>in</sub> to 10% I <sub>D</sub> )	R <sub>L</sub> = 4.7 Ω, V <sub>in</sub> = 10 to 0 V, V <sub>DD</sub> = 12 V	T <sub>(off)</sub>	-	80	100	μs
Slew Rate On	R <sub>L</sub> = 4.7 Ω, V <sub>in</sub> = 0 to 10 V, V <sub>DD</sub> = 12 V	-dV <sub>DS</sub> /dt <sub>on</sub>	-	1.4	-	V/μs
Slew Rate Off	R <sub>L</sub> = 4.7 Ω, V <sub>in</sub> = 10 to 0 V, V <sub>DD</sub> = 12 V	dV <sub>DS</sub> /dt <sub>off</sub>	-	0.5	-	V/μs

### SELF PROTECTION CHARACTERISTICS (T<sub>J</sub> = 25°C unless otherwise noted) (Note 5)

Current Limit	(V <sub>GS</sub> = 5.0 Vdc) V <sub>DS</sub> = 10 V (V <sub>GS</sub> = 5.0 Vdc, T <sub>J</sub> = 150°C)	I <sub>LIM</sub>	12 7.0	18 13	24 18	Adc
Current Limit	(V <sub>GS</sub> = 10 Vdc) V <sub>DS</sub> = 10 V (V <sub>GS</sub> = 10 Vdc, T <sub>J</sub> = 150°C)	I <sub>LIM</sub>	18 13	22 18	30 25	Adc
Temperature Limit (Turn-off)	V <sub>GS</sub> = 5.0 Vdc	T <sub>LIM(off)</sub>	150	175	200	°C
Thermal Hysteresis	V <sub>GS</sub> = 5.0 Vdc	ΔT <sub>LIM(on)</sub>	-	15	-	°C
Temperature Limit (Turn-off)	V <sub>GS</sub> = 10 Vdc	T <sub>LIM(off)</sub>	150	165	185	°C
Thermal Hysteresis	V <sub>GS</sub> = 10 Vdc	ΔT <sub>LIM(on)</sub>	-	15	-	°C

### ESD ELECTRICAL CHARACTERISTICS (T<sub>J</sub> = 25°C unless otherwise noted)

Electro-Static Discharge Capability	Human Body Model (HBM)	ESD	4000	-	-	V
Electro-Static Discharge Capability	Machine Model (MM)	ESD	400	-	-	V

- Pulse Test: Pulse Width = 300 μs, Duty Cycle = 2%.
- Fault conditions are viewed as beyond the normal operating range of the part.

TYPICAL PERFORMANCE CURVES

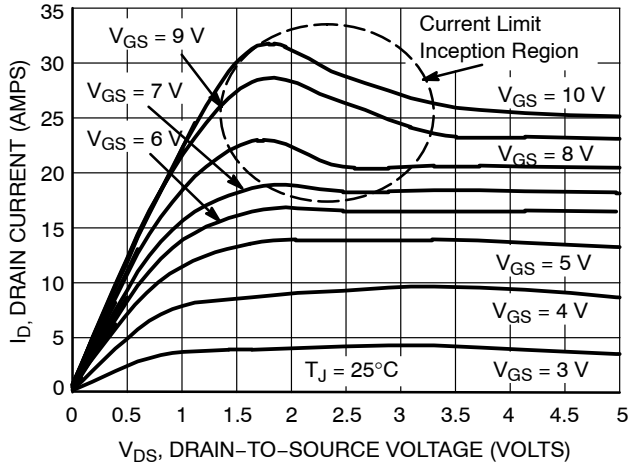

Figure 1. On-Region Characteristics

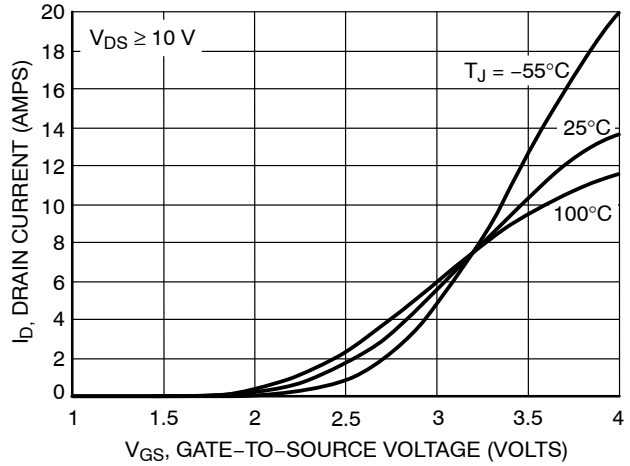

Figure 2. Transfer Characteristics

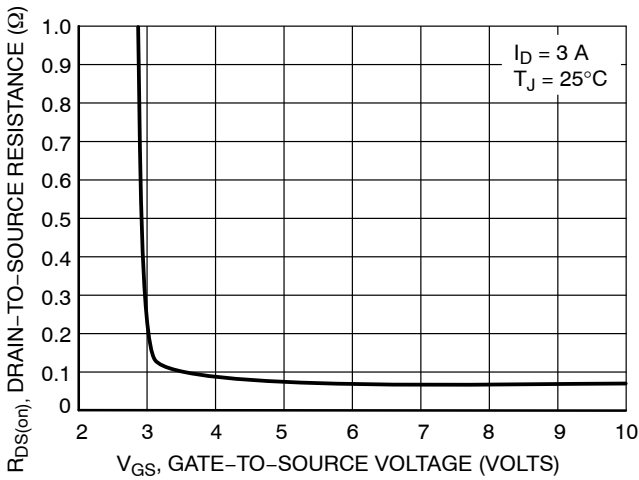

Figure 3. On-Resistance vs. Gate-to-Source Voltage

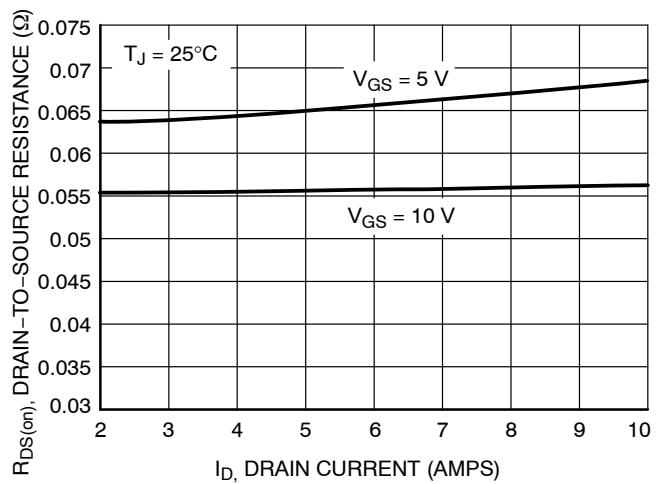

Figure 4. On-Resistance vs. Drain Current and Gate Voltage

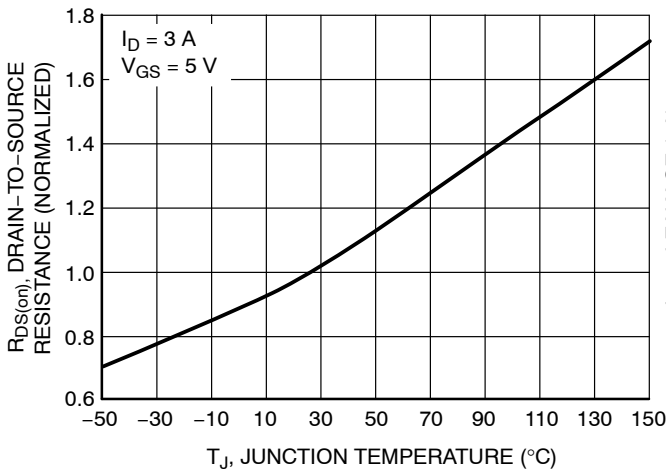

Figure 5. On-Resistance Variation with Temperature

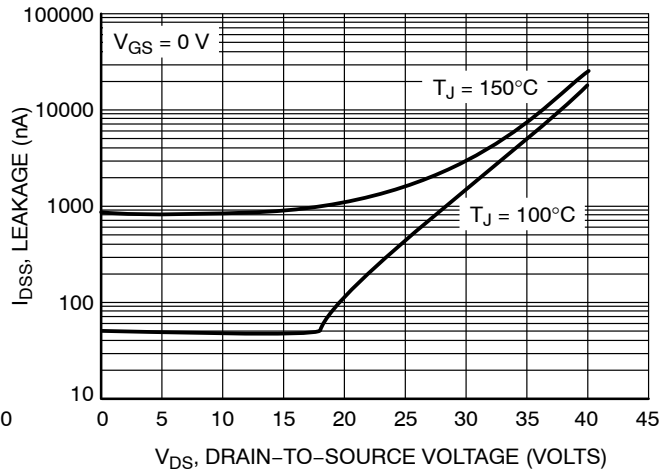

Figure 6. Drain-to-Source Leakage Current vs. Voltage

# NIF5003N

## TYPICAL PERFORMANCE CURVES

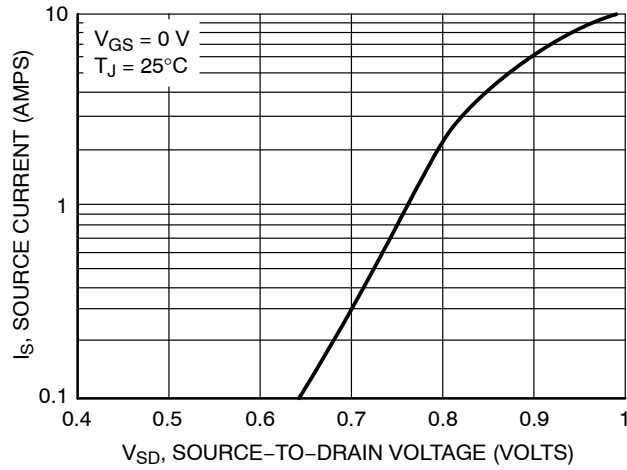

Figure 7. Diode Forward Voltage vs. Current

### ORDERING INFORMATION

Device	Package	Shipping <sup>†</sup>
NIF5003NT1	SOT-223	1000 / Tape & Reel
NIF5003NT1G	SOT-223 (Pb-Free)	1000 / Tape & Reel
NIF5003NT3	SOT-223	4000 / Tape & Reel
NIF5003NT3G	SOT-223 (Pb-Free)	4000 / Tape & Reel

<sup>†</sup>For information on tape and reel specifications, including part orientation and tape sizes, please refer to our Tape and Reel Packaging Specifications Brochure, BRD8011/D.

# MECHANICAL CASE OUTLINE

## PACKAGE DIMENSIONS

ON Semiconductor®



SCALE 1:1

SOT-223 (TO-261)  
CASE 318E-04  
ISSUE R

DATE 02 OCT 2018

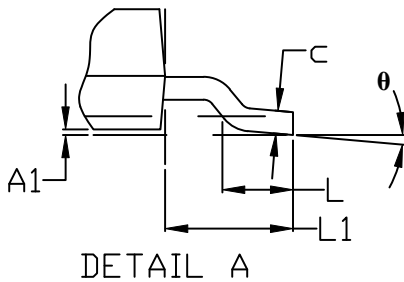
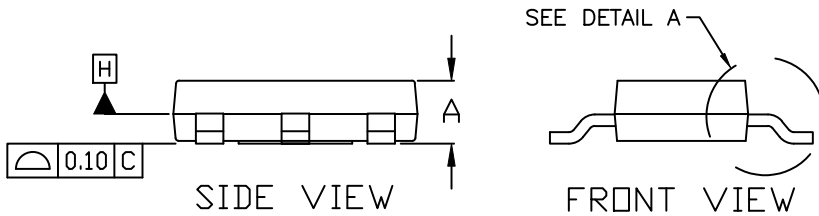
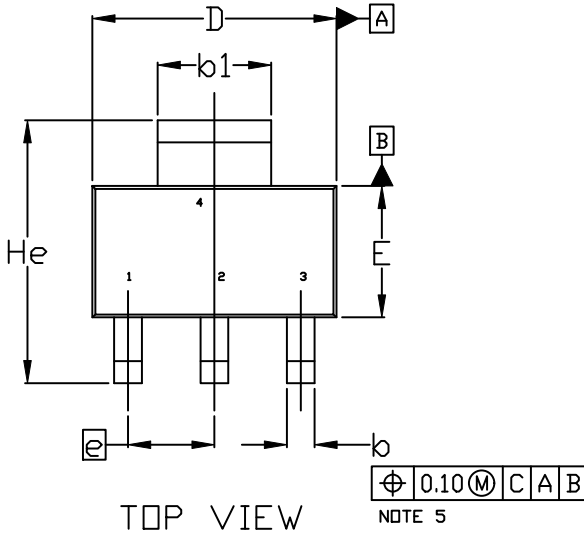

NOTES:

1. DIMENSIONING AND TOLERANCING PER ASME Y14.5M, 1994.
2. CONTROLLING DIMENSION: MILLIMETERS
3. DIMENSIONS D & E DO NOT INCLUDE MOLD FLASH, PROTRUSIONS OR GATE BURRS. MOLD FLASH, PROTRUSIONS OR GATE BURRS SHALL NOT EXCEED 0.200MM PER SIDE.
4. DATUMS A AND B ARE DETERMINED AT DATUM H.
5. A1 IS DEFINED AS THE VERTICAL DISTANCE FROM THE SEATING PLANE TO THE LOWEST POINT OF THE PACKAGE BODY.
6. POSITIONAL TOLERANCE APPLIES TO DIMENSIONS b AND b1.

MILLIMETERS			
DIM	MIN.	NOM.	MAX.
A	1.50	1.63	1.75
A1	0.02	0.06	0.10
b	0.60	0.75	0.89
b1	2.90	3.06	3.20
c	0.24	0.29	0.35
D	6.30	6.50	6.70
E	3.30	3.50	3.70
e	2.30 BSC		
L	0.20	---	---
L1	1.50	1.75	2.00
He	6.70	7.00	7.30
θ	0°	---	10°

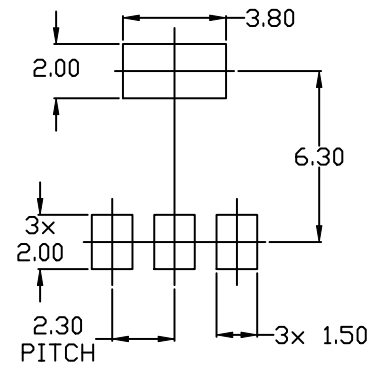

DOCUMENT NUMBER:	98ASB42680B	Electronic versions are uncontrolled except when accessed directly from the Document Repository. Printed versions are uncontrolled except when stamped "CONTROLLED COPY" in red.
DESCRIPTION:	SOT-223 (TO-261)	PAGE 1 OF 2

ON Semiconductor and are trademarks of Semiconductor Components Industries, LLC dba ON Semiconductor or its subsidiaries in the United States and/or other countries. ON Semiconductor reserves the right to make changes without further notice to any products herein. ON Semiconductor makes no warranty, representation or guarantee regarding the suitability of its products for any particular purpose, nor does ON Semiconductor assume any liability arising out of the application or use of any product or circuit, and specifically disclaims any and all liability, including without limitation special, consequential or incidental damages. ON Semiconductor does not convey any license under its patent rights nor the rights of others.

**SOT-223 (TO-261)**  
**CASE 318E-04**  
**ISSUE R**

DATE 02 OCT 2018

- |  |   |   |   |   |
|--|---|---|---|---|
| <b>STYLE 1:</b><br>PIN 1. BASE<br>2. COLLECTOR<br>3. EMITTER<br>4. COLLECTOR | <b>STYLE 2:</b><br>PIN 1. ANODE<br>2. CATHODE<br>3. NC<br>4. CATHODE        | <b>STYLE 3:</b><br>PIN 1. GATE<br>2. DRAIN<br>3. SOURCE<br>4. DRAIN           | <b>STYLE 4:</b><br>PIN 1. SOURCE<br>2. DRAIN<br>3. GATE<br>4. DRAIN   | <b>STYLE 5:</b><br>PIN 1. DRAIN<br>2. GATE<br>3. SOURCE<br>4. GATE    |
| <b>STYLE 6:</b><br>PIN 1. RETURN<br>2. INPUT<br>3. OUTPUT<br>4. INPUT        | <b>STYLE 7:</b><br>PIN 1. ANODE 1<br>2. CATHODE<br>3. ANODE 2<br>4. CATHODE | <b>STYLE 8:</b><br>CANCELLED  | <b>STYLE 9:</b><br>PIN 1. INPUT<br>2. GROUND<br>3. LOGIC<br>4. GROUND | <b>STYLE 10:</b><br>PIN 1. CATHODE<br>2. ANODE<br>3. GATE<br>4. ANODE |
| <b>STYLE 11:</b><br>PIN 1. MT 1<br>2. MT 2<br>3. GATE<br>4. MT 2             | <b>STYLE 12:</b><br>PIN 1. INPUT<br>2. OUTPUT<br>3. NC<br>4. OUTPUT         | <b>STYLE 13:</b><br>PIN 1. GATE<br>2. COLLECTOR<br>3. EMITTER<br>4. COLLECTOR |   |   |

**GENERIC  
 MARKING DIAGRAM\***



- A = Assembly Location
- Y = Year
- W = Work Week
- XXXXX = Specific Device Code
- = Pb-Free Package

(Note: Microdot may be in either location)

\*This information is generic. Please refer to device data sheet for actual part marking. Pb-Free indicator, "G" or microdot "▪", may or may not be present. Some products may not follow the Generic Marking.

<b>DOCUMENT NUMBER:</b>	<b>98ASB42680B</b>	Electronic versions are uncontrolled except when accessed directly from the Document Repository. Printed versions are uncontrolled except when stamped "CONTROLLED COPY" in red.
<b>DESCRIPTION:</b>	<b>SOT-223 (TO-261)</b>	<b>PAGE 2 OF 2</b>

ON Semiconductor and are trademarks of Semiconductor Components Industries, LLC dba ON Semiconductor or its subsidiaries in the United States and/or other countries. ON Semiconductor reserves the right to make changes without further notice to any products herein. ON Semiconductor makes no warranty, representation or guarantee regarding the suitability of its products for any particular purpose, nor does ON Semiconductor assume any liability arising out of the application or use of any product or circuit, and specifically disclaims any and all liability, including without limitation special, consequential or incidental damages. ON Semiconductor does not convey any license under its patent rights nor the rights of others.

**onsemi**, **Onsemi**, and other names, marks, and brands are registered and/or common law trademarks of Semiconductor Components Industries, LLC dba "**onsemi**" or its affiliates and/or subsidiaries in the United States and/or other countries. **onsemi** owns the rights to a number of patents, trademarks, copyrights, trade secrets, and other intellectual property. A listing of **onsemi**'s product/patent coverage may be accessed at [www.onsemi.com/site/pdf/Patent-Marking.pdf](http://www.onsemi.com/site/pdf/Patent-Marking.pdf). **onsemi** reserves the right to make changes at any time to any products or information herein, without notice. The information herein is provided "as-is" and **onsemi** makes no warranty, representation or guarantee regarding the accuracy of the information, product features, availability, functionality, or suitability of its products for any particular purpose, nor does **onsemi** assume any liability arising out of the application or use of any product or circuit, and specifically disclaims any and all liability, including without limitation special, consequential or incidental damages. Buyer is responsible for its products and applications using **onsemi** products, including compliance with all laws, regulations and safety requirements or standards, regardless of any support or applications information provided by **onsemi**. "Typical" parameters which may be provided in **onsemi** data sheets and/or specifications can and do vary in different applications and actual performance may vary over time. All operating parameters, including "Typicals" must be validated for each customer application by customer's technical experts. **onsemi** does not convey any license under any of its intellectual property rights nor the rights of others. **onsemi** products are not designed, intended, or authorized for use as a critical component in life support systems or any FDA Class 3 medical devices or medical devices with a same or similar classification in a foreign jurisdiction or any devices intended for implantation in the human body. Should Buyer purchase or use **onsemi** products for any such unintended or unauthorized application, Buyer shall indemnify and hold **onsemi** and its officers, employees, subsidiaries, affiliates, and distributors harmless against all claims, costs, damages, and expenses, and reasonable attorney fees arising out of, directly or indirectly, any claim of personal injury or death associated with such unintended or unauthorized use, even if such claim alleges that **onsemi** was negligent regarding the design or manufacture of the part. **onsemi** is an Equal Opportunity/Affirmative Action Employer. This literature is subject to all applicable copyright laws and is not for resale in any manner.

## PUBLICATION ORDERING INFORMATION

### LITERATURE FULFILLMENT:

Email Requests to: [orderlit@onsemi.com](mailto:orderlit@onsemi.com)

**onsemi Website:** [www.onsemi.com](http://www.onsemi.com)

### TECHNICAL SUPPORT

**North American Technical Support:**

Voice Mail: 1 800-282-9855 Toll Free USA/Canada

Phone: 011 421 33 790 2910

**Europe, Middle East and Africa Technical Support:**

Phone: 00421 33 790 2910

For additional information, please contact your local Sales Representative