

300 mA very low dropout linear regulator IC



DFN4 1x1

Features

- Input voltage from 1.5 to 5.5 V
- Ultra low dropout voltage (135 mV typ. at 300 mA load)
- Very low quiescent current (28 μ A typ. at no load, 0.03 μ A typ. in off mode)
- Internal current fold-back
- Output voltage tolerance: $\pm 1\%$ @ 25 $^{\circ}$ C
- 300 mA guaranteed output current
- High PSRR: 75 dB@1 kHz
- Wide range of output voltages available on request: from 0.8 V up to 5.0 V in 50 mV step
- Logic-controlled electronic shutdown
- Internal soft-start
- Optional output voltage discharge feature
- Compatible with ceramic capacitor $C_{OUT} = 0.47\ \mu$ F
- Thermal protection
- Available in DFN4 1x1
- Operating temperature range: -40 $^{\circ}$ C to 125 $^{\circ}$ C

Description

The LD59030 high accuracy voltage regulator provides 300 mA of maximum current from an input voltage ranging from 1.5 V to 5.5 V, with a typical dropout voltage of 135 mV at $V_{OUT} = 3.3$ V.

It is available in DFN4 1x1 package, allowing the maximum space saving.

The device works with a ceramic capacitor on the output. The ultra-low drop voltage, low quiescent current and low noise features, together with the internal soft-start circuit and output current fold-back protection, make the LD59030 suitable for low power battery-operated applications.

An enable logic control function puts the LD59030 in shutdown mode allowing a total current consumption lower than 0.03 μ A.

Maturity status link

[LD59030](#)

1 Diagram

Figure 1. Block diagram

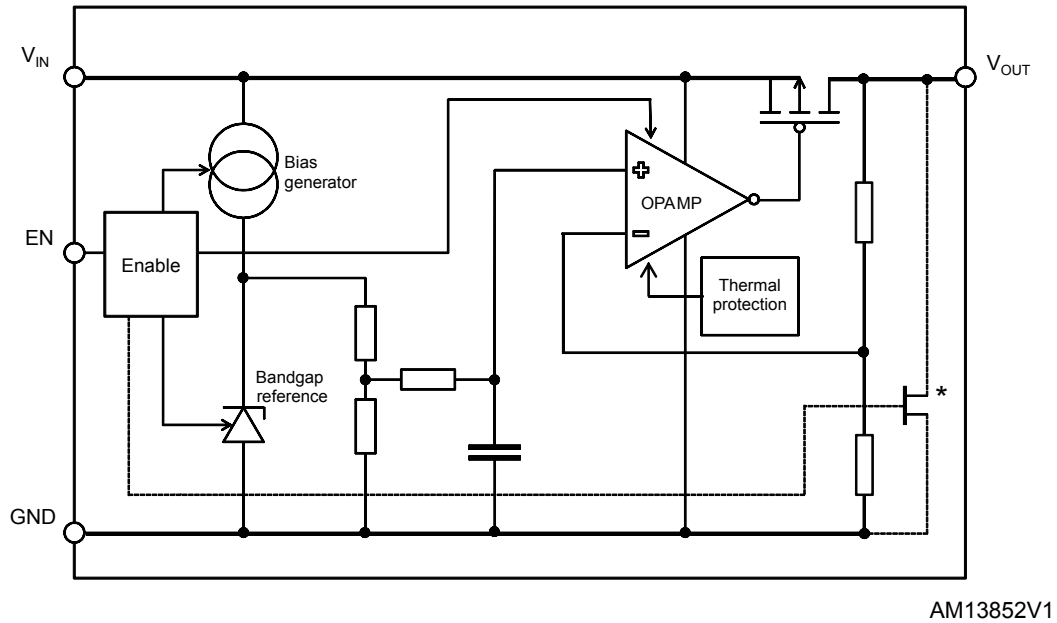

AM13852V1

Note: The output discharge MOSFET is optional.

2 Pin configuration

Figure 2. Pin connection (top view)

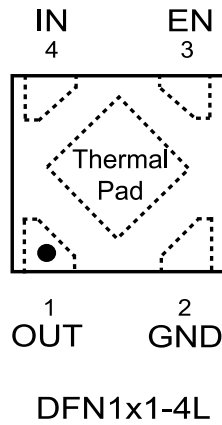
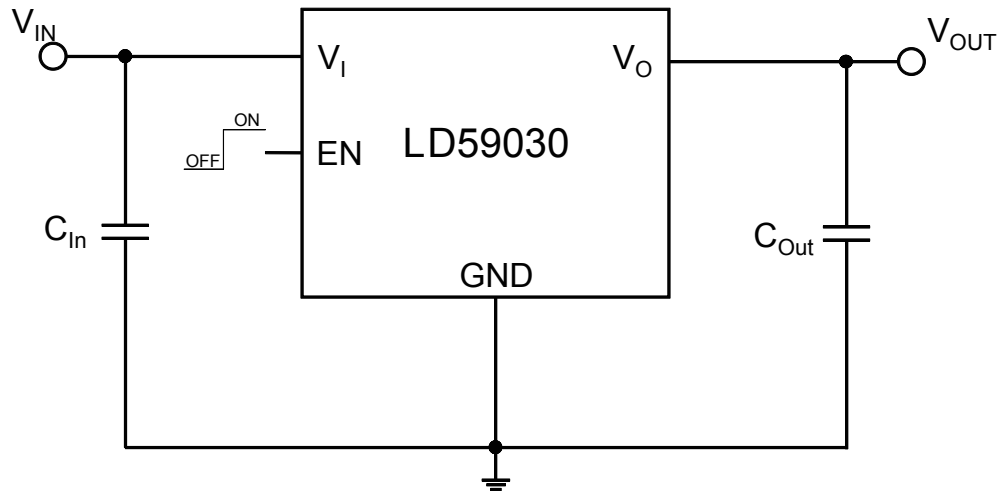

Table 1. Pin description

Pin n° DFN4 1x1	Symbol	Function
1	OUT	Output voltage
2	GND	Common ground
3	EN	Enable pin logic input: Low = shutdown, High = active
4	IN	Input voltage
Thermal pad	-	Connect to GND

3 Typical application

Figure 3. Typical application circuit



4 Maximum ratings

Table 2. Absolute maximum ratings

Symbol	Parameter	Value	Unit
V _{IN}	Input voltage	- 0.3 to 7	V
V _{OUT}	Output voltage	- 0.3 to V _{IN} + 0.3	V
V _{EN}	Enable input voltage	- 0.3 to 7	V
I _{OUT}	Output current	Internally limited	mA
P _D	Power dissipation	Internally limited	mW
T _{STG}	Storage temperature range	- 40 to 150	°C
T _{OP}	Operating junction temperature range	- 40 to 125	°C

Note: *Absolute maximum ratings are those values beyond which damage to the device may occur. Functional operation under these conditions is not implied. All values are referred to GND.*

Table 3. Thermal data

Symbol	Parameter	Value	Unit
R _{thJA}	Thermal resistance junction-ambient	140	°C/W

Table 4. ESD Performance

Symbol	Parameter	Test conditions	Value	Unit
ESD	ESD Protection voltage	HBM	2	kV
		CDM	500	V

Note: *Thermal Pad, which is tied to internal substrate for thermal dissipation purpose, is able to sustain 1000 V of HBM voltage which allows safe manufacturing with a standard ESD control process as per JEDEC document JEP155.*

5 Electrical characteristics

$T_J = 25\text{ °C}$, $V_{IN} = V_{OUT(NOM)} + 1\text{ V}$, $C_{IN} = C_{OUT} = 1\text{ }\mu\text{F}$, $I_{OUT} = 1\text{ mA}$, $V_{EN} = V_{IN}$, unless otherwise specified.

Table 5. Electrical characteristics

Symbol	Parameter	Test conditions	Min.	Typ.	Max.	Unit
V_{IN}	Operating input voltage		1.5		5.5	V
V_{OUT}	V_{OUT} accuracy	$I_{OUT} = 1\text{ mA}$, $T_J = 25\text{ °C}$	-1		1	%
		$I_{OUT} = 1\text{ mA}$, $-40\text{ °C} < T_J < 85\text{ °C}$	-2		2	%
ΔV_{OUT}	Static line regulation ⁽¹⁾	$V_{OUT(NOM)} + 1\text{ V} \leq V_{IN} \leq 5.5\text{ V}$, $I_{OUT} = 10\text{ mA}$		0.015		%V
		$-40\text{ °C} < T_J < 85\text{ °C}$			0.05	
ΔV_{OUT}	Static load regulation	$I_{OUT} = 0\text{ mA to }300\text{ mA}$		-20		mV
		$I_{OUT} = 0\text{ mA to }300\text{ mA}$ $-40\text{ °C} < T_J < 85\text{ °C}$		-0.004	-0.01	%/mA
V_{DROP}	Dropout voltage	$I_{OUT} = 30\text{ mA}$, $V_{OUT} = 2.8\text{ V}$		20		mV
		$I_{OUT} = 300\text{ mA}$, $V_{OUT} = 2.8\text{ V}$ $-40\text{ °C} < T_J < 85\text{ °C}$		155	230	
e_N	Output noise voltage	10 Hz to 100 kHz, $I_{OUT} = 10\text{ mA}$, $V_{OUT} = 1.8\text{ V}$		70		μV_{RMS}
SVR	Supply voltage rejection	$V_{IN} = V_{OUT(NOM)} + 1\text{ V} \pm V_{RIPPLE}$ $V_{RIPPLE} = 0.2\text{ V}$ Freq. = 1 kHz $I_{OUT} = 30\text{ mA}$		75		dB
		$V_{IN} = V_{OUT(NOM)} + 1\text{ V} \pm V_{RIPPLE}$ $V_{RIPPLE} = 0.2\text{ V}$ Freq. = 100 kHz $I_{OUT} = 30\text{ mA}$		55		
I_Q	Quiescent current	$I_{OUT} = 0\text{ mA}$		28	40	μA
		$I_{OUT} = 300\text{ mA}$		305		
$I_{Standby}$	Standby current	V_{IN} input current in OFF MODE: $V_{EN} = \text{GND}$		0.03	1	μA
I_{LIM}	Current limit	$V_{OUT} = 0.9 \times V_{OUT(NOM)}$		500		mA
I_{SC}	Short circuit current	$V_{OUT} = 0$ (foldback protection)	120	170		mA
R_{ON}	Output voltage discharge MOSFET	(LD59030DT version) $I_{OUT} = 1\text{ mA}$		120		Ω
V_{EN}	Enable input logic low	$V_{IN} = 1.5\text{ V to }5.5\text{ V}$ $-40\text{ °C} < T_J < 85\text{ °C}$			0.4	V
	Enable input logic high	$V_{IN} = 1.5\text{ V to }5.5\text{ V}$ $-40\text{ °C} < T_J < 85\text{ °C}$	1			
I_{EN}	Enable pin input current	$V_{EN} = V_{IN}$			100	nA
T_{ON} ⁽²⁾	Turn on time			145		μs
T_{SHDN}	Thermal shutdown			160		$^{\circ}\text{C}$
	Hysteresis			20		

Symbol	Parameter	Test conditions	Min.	Typ.	Max.	Unit
C _{OUT}	Output capacitor	Capacitance (see Figure 15. Stability area vs. (C _{OUT} , ESR))	0.47		22	μF

1. Not applicable for $V_{OUT(NOM)} > 4.5\text{ V}$
2. Turn-on time is time measured between the enable input just exceeding VEN high value and the output voltage just reaching 95 % of its nominal value

6 Application information

6.1 Soft-start function

The LD59030 has an internal soft start circuit. By increasing the startup time up to 145 μ s, without the need of any external soft start capacitor, this feature is able to keep the regulator inrush current at startup under control.

6.2 Output discharge function

The LD59030 integrates a MOSFET connected between V_{OUT} and GND. This transistor is activated when the EN pin goes to low logic level and has the function to quickly discharge the output capacitor when the device is disabled by the user.

The device is available with or without auto-discharge feature.

See [Section 9 Ordering information](#) for more details.

6.3 Dropout voltage

Table 6. Dropout voltage at $I_{OUT} = 300$ mA

Output voltage [V]	Typical value [mV] $T_J = 25^\circ\text{C}$	Max value [mV] $-40^\circ\text{C} < T_J < 85^\circ\text{C}$
1.05	400	550
1.2	330	490
1.5	260	390
1.8	180 ⁽¹⁾	210 ⁽¹⁾
2.5	165	253
2.8	155	230
3.0	145	220
3.1	140	210
3.3	135	200

1. Measured value.

6.4 Input and output capacitors

The LD59030 requires external capacitors to assure the regulator control loop stability.

Any good quality ceramic capacitor can be used but, the X5R and the X7R are suggested since they guarantee a very stable combination of capacitance and ESR over the whole temperature range.

Locating the input/output capacitors as close as possible to the relative pins is recommended.

The LD59030 requires an input capacitor with a minimum value of 1 μ F. This capacitor must be located as close as possible to the input pin of the device and returned to a clean analog ground.

The control loop of the LD59030 is designed to work with an output ceramic capacitor.

This capacitor must meet the requirements of minimum capacitance and equivalent series resistance (ESR), as shown in [Figure 15. Stability area vs. \(\$C_{OUT}\$, ESR\)](#). To assure stability, the output capacitor must maintain its ESR and capacitance in the stable region, over the full operating temperature range.

In order to keep stability in all operating conditions (temperature, input voltage and load variations), a minimum output capacitor of 0.47 μ F is recommended.

The suggested combination of 1 μ F input and output capacitors offers a good compromise among the stability of the regulator, optimum transient response and total PCB area occupation.

7 Typical characteristics

($C_{IN} = C_{OUT} = 1 \mu\text{F}$, V_{EN} to V_{IN} , $T_J = 25^\circ\text{C}$ unless otherwise specified).

Figure 4. Output voltage vs. temperature ($V_{OUT} = 1.8 \text{ V}$; $I_{OUT} = 1 \text{ mA}$)

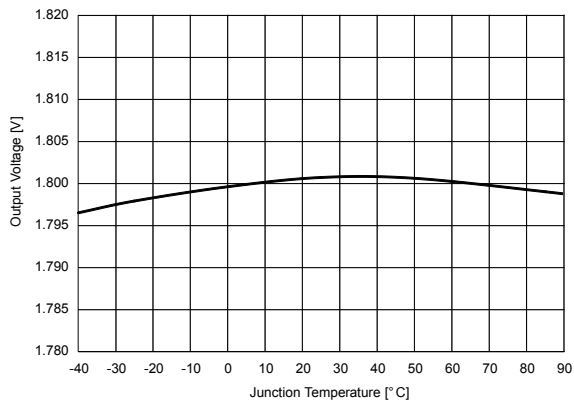

Figure 5. Output voltage vs. temperature ($V_{OUT} = 1.8 \text{ V}$; $I_{OUT} = 300 \text{ mA}$)

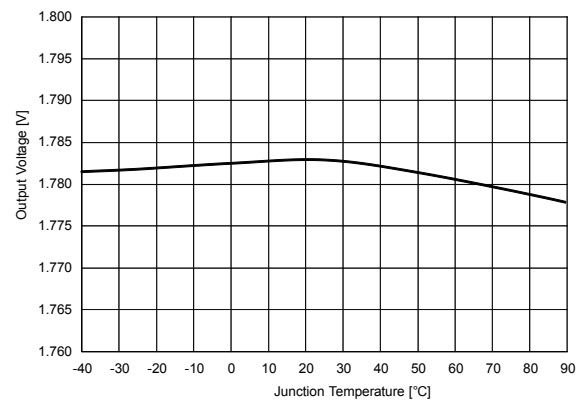

Figure 6. Line regulation vs. temperature ($V_{IN} = 2.8 \text{ V}$ to 5.5 V ; $V_{OUT} = 1.8 \text{ V}$; $I_{OUT} = 10 \text{ mA}$)

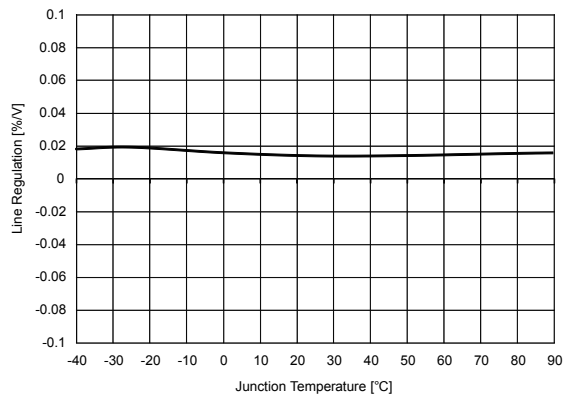

Figure 7. Load regulation vs. temperature ($V_{OUT} = 1.8 \text{ V}$; $I_{OUT} = 0$ to 300 mA)

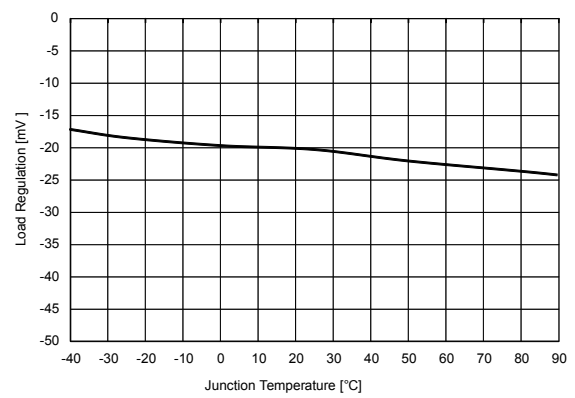

Figure 8. Quiescent current vs. temperature ($I_{OUT} = 0$ mA)

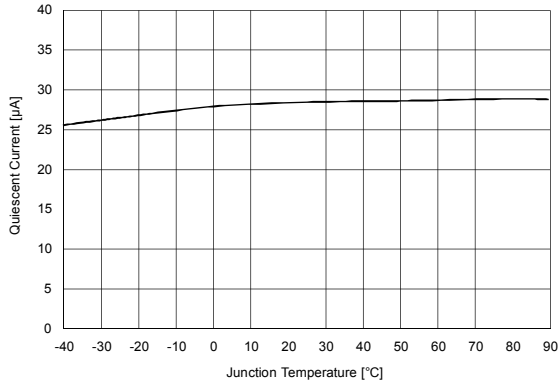

Figure 9. Quiescent current vs. temperature ($I_{OUT} = 300$ mA)

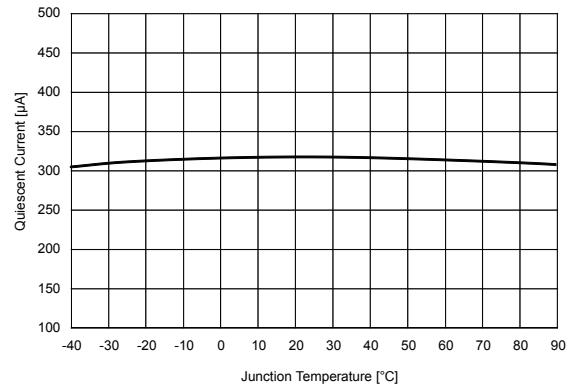

Figure 10. Shutdown current vs. temperature

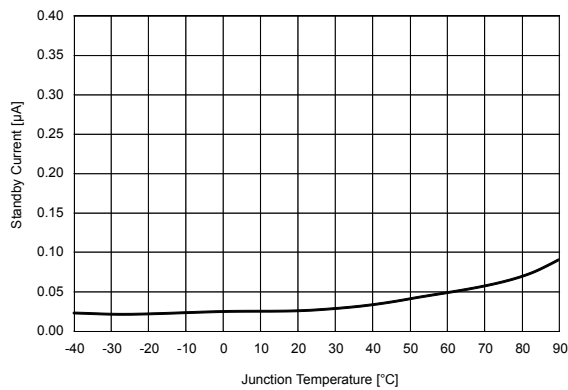

Figure 11. Dropout voltage vs. load current

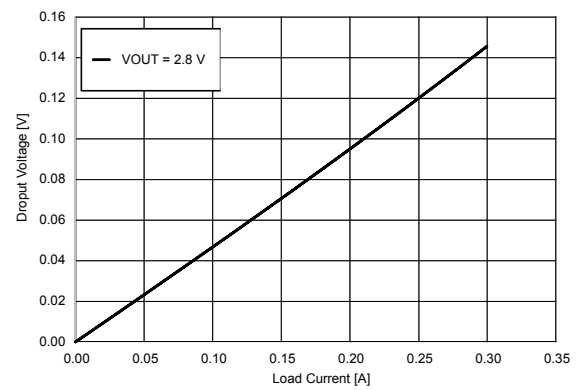

Figure 12. Quiescent current vs. output current ($V_{IN} = 2.8$ V; $V_{OUT} = 1.8$ V)

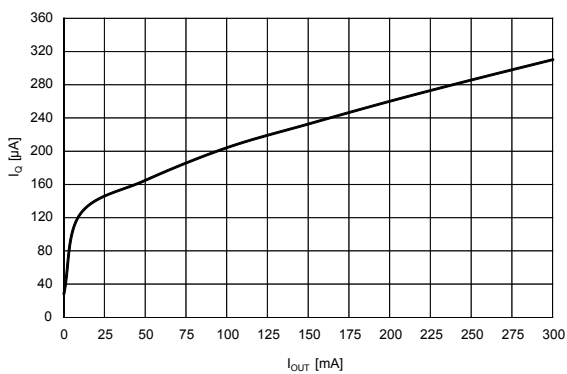

Figure 13. Dropout voltage vs. temperature ($V_{OUT} = 1.8$ V; $I_{OUT} = 300$ mA)

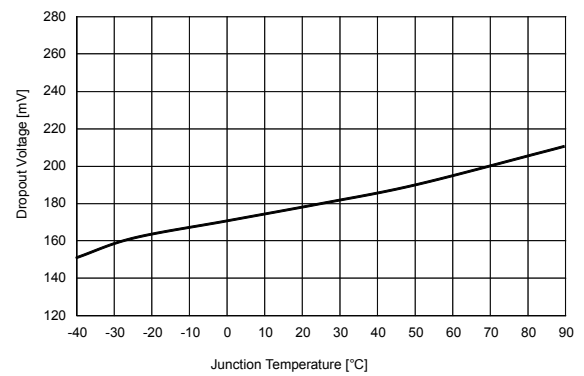

Figure 14. Supply voltage rejection vs. frequency

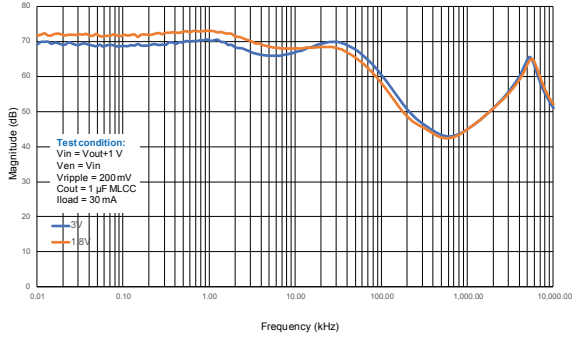

Figure 15. Stability area vs. (C_{OUT}, ESR)

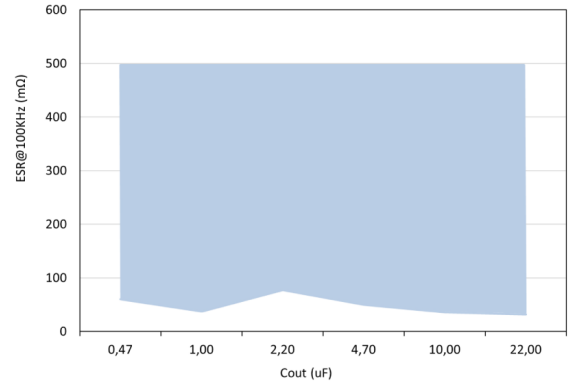

Figure 16. Output noise spectral density (V_{OUT} = 1.8 V)

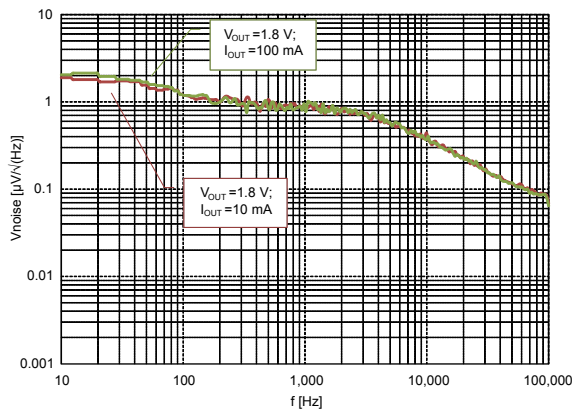

Figure 17. Output noise spectral density (V_{OUT} = 2.8 V)

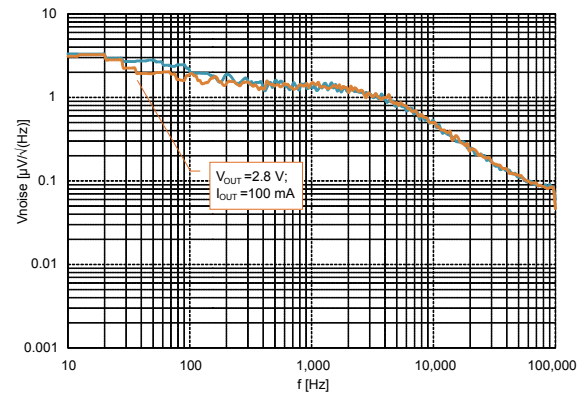

Figure 18. Turn-on Time (V_{OUT} = 1.8 V; I_{OUT} = 0 A, V_{IN} = 2.8 V, t_r = t_f = 1 µs)

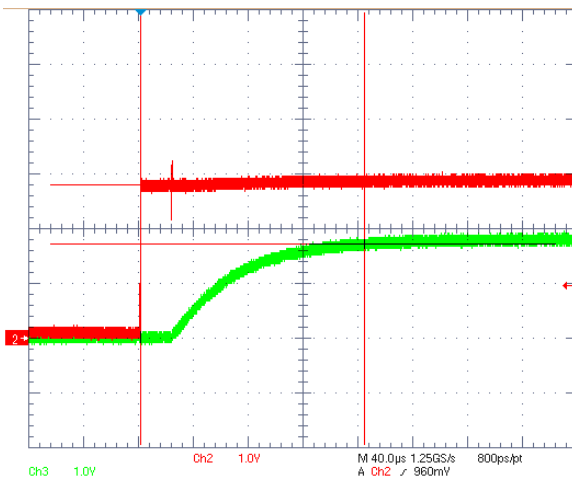

Figure 19. Line transient (V_{OUT} = 1.8 V; I_{OUT} = 10 mA, t_r = t_f = 1 µs)

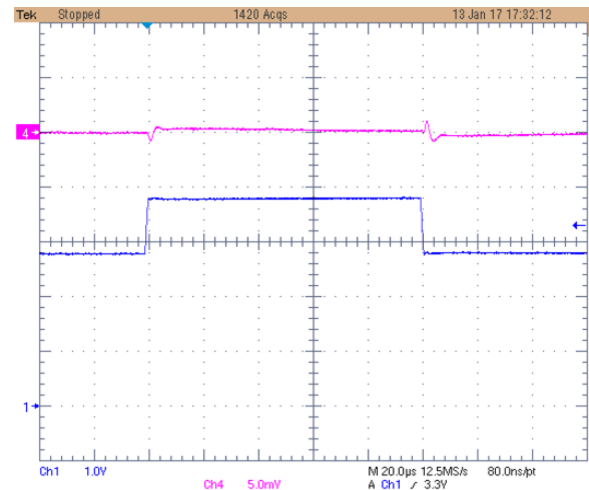

Figure 20. Output voltage vs. input voltage

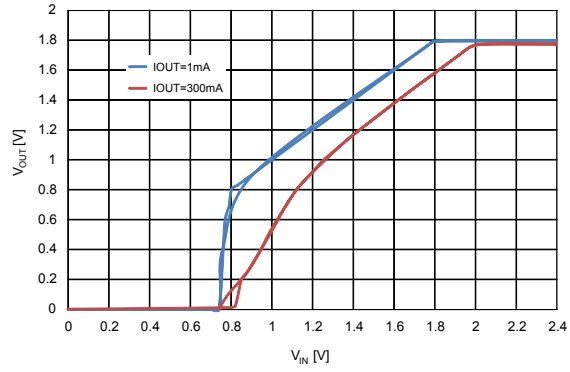
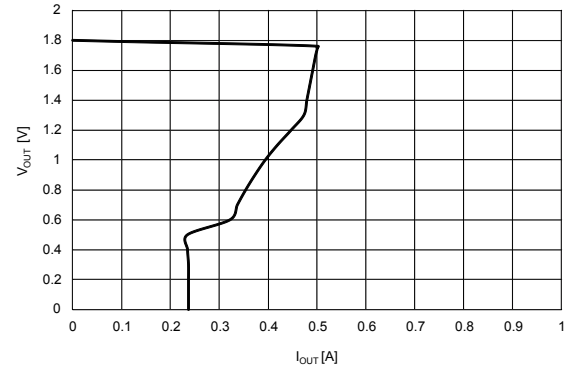

Figure 21. Output voltage vs. output current



8 Package information

In order to meet environmental requirements, ST offers these devices in different grades of **ECOPACK** packages, depending on their level of environmental compliance. ECOPACK specifications, grade definitions and product status are available at: www.st.com. ECOPACK is an ST trademark.

8.1 DFN4 1x1 package info

Figure 22. DFN4 1x1 package outline

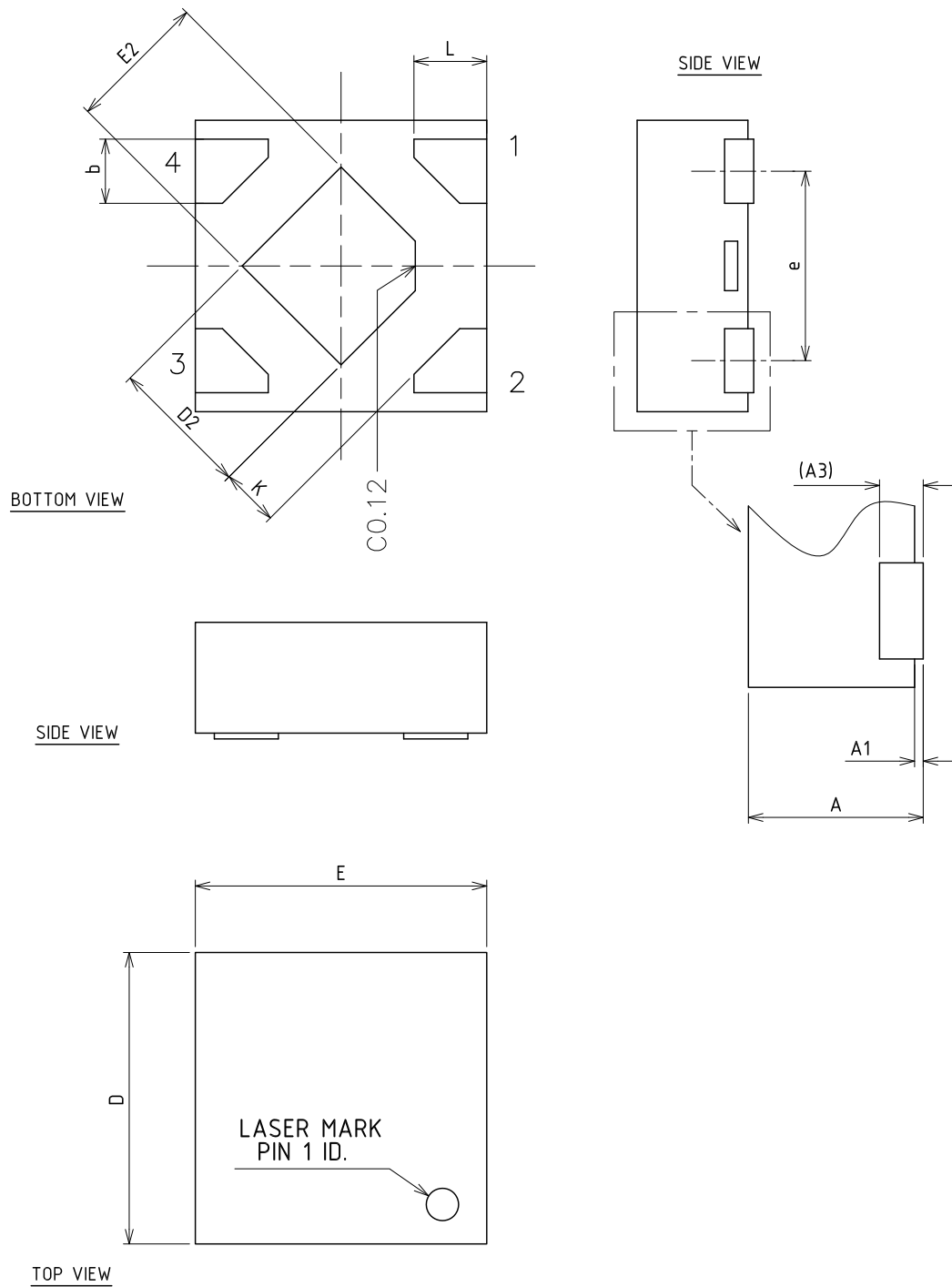

8405587_A

Table 7. DFN4 1x1 mechanical data

Dim.	mm		
	Min.	Typ.	Max.
A	0.34	0.37	0.40
A1	0	0.02	0.05
A3		0.10	
b	0.17	0.22	0.27
D	0.95	1.00	1.05
D2	0.43	0.48	0.53
E	0.95	1.00	1.05
E2	0.43	0.48	0.53
e		0.65	
L	0.20	0.25	0.30
K	0.15		

Figure 24. DFN4 1x1 tape outline

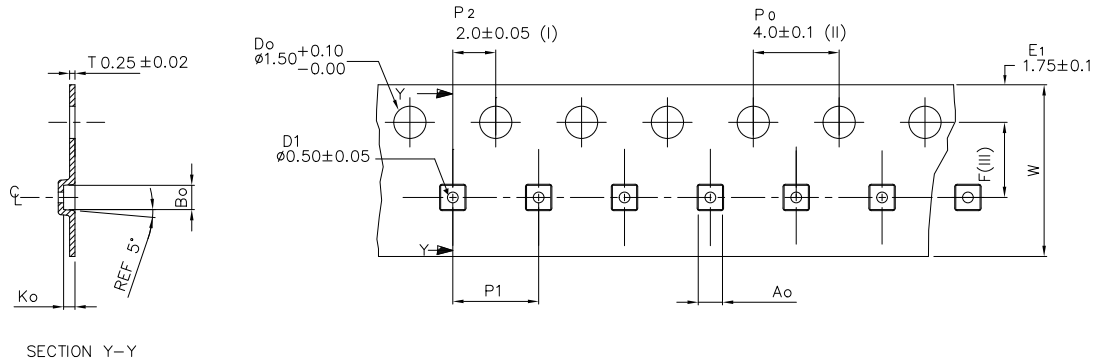

A ₀	1.13 +/−0.05
B ₀	1.13 +/−0.05
K ₀	0.53 +/−0.05
F	3.50 +/−0.05
P ₁	4.00 +/−0.10
W	8.00 +0.3/−0.1

- (I) Measured from centreline of sprocket hole to centreline of pocket.
- (II) Cumulative tolerance of 10 sprocket holes is ± 0.20 .
- (III) Measured from centreline of sprocket hole to centreline of pocket.
- (IV) Other material available.
- (V) Typical SR of form tape Max. 10° OHM/SR

ALL DIMENSIONS IN MILLIMETRES UNLESS OTHERWISE STATED.

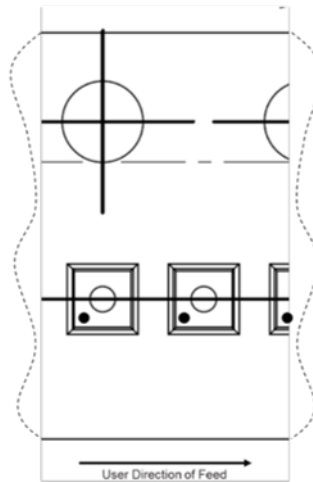
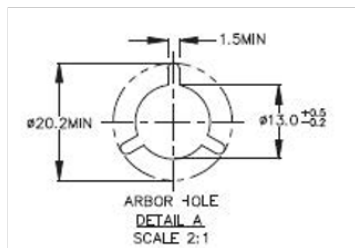
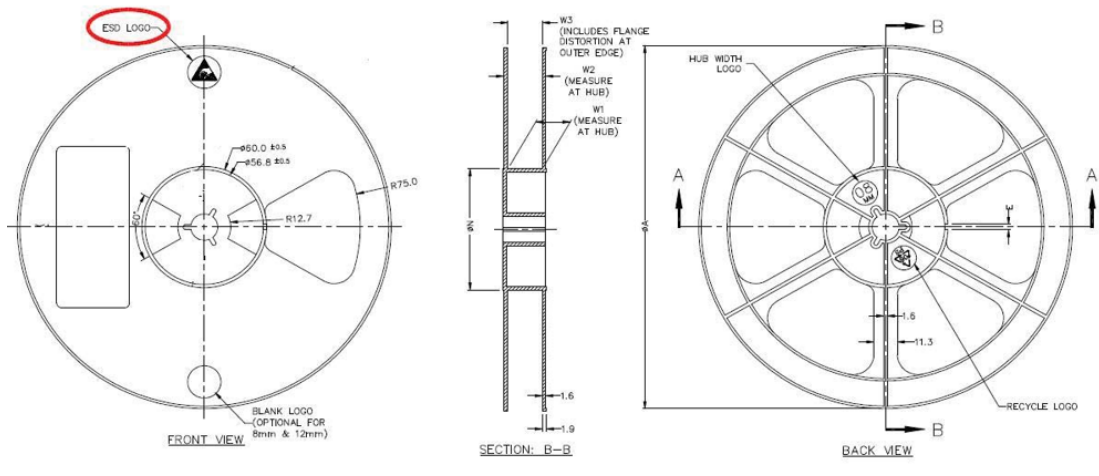

Figure 25. DFN4 1x1 reel outline



Tape width (mm)	A max.	N min.	W1 max.	W2 max.	W3 min. / max.
8	180	60	8.4	14.4	7.9 / 10.9

9 Ordering information

Table 8. Order code

Order code	Output voltage (V)	Auto-discharge	Marking
LD59030DTPU105R ⁽¹⁾	1.05	Yes	JQ
LD59030TPU105R ⁽¹⁾		No	KQ
LD59030DTPU12R	1.2	Yes	J5
LD59030TPU12R ⁽¹⁾		No	K5
LD59030DTPU18R	1.8	Yes	J7
LD59030TPU18R ⁽¹⁾		No	K7
LD59030DTPU25R	2.5	Yes	JA
LD59030TPU25R ⁽¹⁾		No	KA
LD59030DTPU28R	2.8	Yes	JC
LD59030TPU28R ⁽¹⁾		No	KC
LD59030DTPU30R	3.0	Yes	JF
LD59030TPU30R ⁽¹⁾		No	KF
LD59030DTPU33R	3.3	Yes	JJ
LD59030TPU33R ⁽¹⁾		No	KJ

1. Available on request

Revision history

Table 9. Document revision history

Date	Revision	Changes
28-Aug-2017	1	Initial release.
03-Nov-2017	2	Datasheet promoted from preliminary data to datasheet. Update Figure 15: "Stability area vs. (COUT, ESR)".
01-Jun-2018	3	Updated: Figure 24. Tape dimensions.
31-Jul-2018	4	Updated: output voltage in Table 6. Dropout voltage at $I_{OUT} = 300$ mA.
24-02-2020	5	Updated Figure 14.
02-Nov-2020	6	Updated Section 8.1.
24-Feb-2021	7	Added footnote in Table 8.
30-Mar-2021	8	Updated: Thermal pad function in Table 1 Added: Note in Table 4

Contents

1	Diagram	2
2	Pin configuration	3
3	Typical application	4
4	Maximum ratings	5
5	Electrical characteristics	6
6	Application information	8
6.1	Soft-start function	8
6.2	Output discharge function	8
6.3	Dropout voltage	8
6.4	Input and output capacitors	8
7	Typical characteristics	9
8	Package information	13
8.1	DFN4 1x1 package information	14
9	Ordering information	19
	Revision history	20

List of tables

Table 1.	Pin description	3
Table 2.	Absolute maximum ratings	5
Table 3.	Thermal data	5
Table 4.	ESD Performance	5
Table 5.	Electrical characteristics	6
Table 6.	Dropout voltage at $I_{OUT} = 300$ mA	8
Table 7.	DFN4 1x1 mechanical data	15
Table 8.	Order code	19
Table 9.	Document revision history	20

List of figures

Figure 1.	Block diagram	2
Figure 2.	Pin connection (top view)	3
Figure 3.	Typical application circuit	4
Figure 4.	Output voltage vs. temperature ($V_{OUT} = 1.8\text{ V}$; $I_{OUT} = 1\text{ mA}$)	9
Figure 5.	Output voltage vs. temperature ($V_{OUT} = 1.8\text{ V}$; $I_{OUT} = 300\text{ mA}$)	9
Figure 6.	Line regulation vs. temperature ($V_{IN} = 2.8\text{ V to } 5.5\text{ V}$; $V_{OUT} = 1.8\text{ V}$; $I_{OUT} = 10\text{ mA}$)	9
Figure 7.	Load regulation vs. temperature ($V_{OUT} = 1.8\text{ V}$; $I_{OUT} = 0\text{ to } 300\text{ mA}$)	9
Figure 8.	Quiescent current vs. temperature ($I_{OUT} = 0\text{ mA}$)	10
Figure 9.	Quiescent current vs. temperature ($I_{OUT} = 300\text{ mA}$)	10
Figure 10.	Shutdown current vs. temperature	10
Figure 11.	Dropout voltage vs. load current	10
Figure 12.	Quiescent current vs. output current ($V_{IN} = 2.8\text{ V}$; $V_{OUT} = 1.8\text{ V}$)	10
Figure 13.	Dropout voltage vs. temperature ($V_{OUT} = 1.8\text{ V}$; $I_{OUT} = 300\text{ mA}$)	10
Figure 14.	Supply voltage rejection vs. frequency	11
Figure 15.	Stability area vs. (C_{OUT} , ESR)	11
Figure 16.	Output noise spectral density ($V_{OUT} = 1.8\text{ V}$)	11
Figure 17.	Output noise spectral density ($V_{OUT} = 2.8\text{ V}$)	11
Figure 18.	Turn-on Time ($V_{OUT} = 1.8\text{ V}$; $I_{OUT} = 0\text{ A}$, $V_{IN} = 2.8\text{ V}$, $t_r = t_f = 1\text{ }\mu\text{s}$)	11
Figure 19.	Line transient ($V_{OUT} = 1.8\text{ V}$; $I_{OUT} = 10\text{ mA}$, $t_r = t_f = 1\text{ }\mu\text{s}$)	11
Figure 20.	Output voltage vs. input voltage	12
Figure 21.	Output voltage vs. output current	12
Figure 22.	DFN4 1x1 package outline	14
Figure 23.	DFN4 1x1 recommended footprint	16
Figure 24.	DFN4 1x1 tape outline	17
Figure 25.	DFN4 1x1 reel outline	18

IMPORTANT NOTICE – PLEASE READ CAREFULLY

STMicroelectronics NV and its subsidiaries (“ST”) reserve the right to make changes, corrections, enhancements, modifications, and improvements to ST products and/or to this document at any time without notice. Purchasers should obtain the latest relevant information on ST products before placing orders. ST products are sold pursuant to ST’s terms and conditions of sale in place at the time of order acknowledgement.

Purchasers are solely responsible for the choice, selection, and use of ST products and ST assumes no liability for application assistance or the design of Purchasers’ products.

No license, express or implied, to any intellectual property right is granted by ST herein.

Resale of ST products with provisions different from the information set forth herein shall void any warranty granted by ST for such product.

ST and the ST logo are trademarks of ST. For additional information about ST trademarks, please refer to www.st.com/trademarks. All other product or service names are the property of their respective owners.

Information in this document supersedes and replaces information previously supplied in any prior versions of this document.

© 2021 STMicroelectronics – All rights reserved