

SOT23 MICROPOWER 1.225V VOLTAGE REFERENCE

DESCRIPTION

The ZXRE4041 is a bandgap circuit designed to achieve a precision micropower voltage reference of 1.225 volts. The device is available in the small outline SOT23 surface mount package which is ideal for applications where space saving is important.

SOT23 tolerance is available to 0.5% C grade for precision applications. Excellent performance is maintained over the 30 μ A to 12mA operating current

FEATURES

- High performance alternative to LM4041
- Small outline SOT23
- SO8 and E-Line alternatives available
- 30 μ A knee current
- 20ppm/ $^{\circ}$ C typical temperature coefficient
- Unconditionally stable
- 0.5%, 1%, 2% and 3% tolerance
- Contact Zetex marketing for availability of tighter tolerance devices

range with a typical temperature coefficient of only 20ppm/ $^{\circ}$ C. The device has been designed to be highly tolerant of capacitive loads so maintaining excellent stability.

This device offers a SOT23 pin for pin compatible alternative to LM4041 voltage references. SO8 and E-Line (TO92 style) packages can also be made available.

APPLICATIONS

- Battery powered equipment
- Precision power supplies
- Portable instrumentation
- Portable communications devices
- Notebook and palmtop computers
- Data acquisition systems
- A/D and D/A converters
- Test equipment

SCHEMATIC DIAGRAM

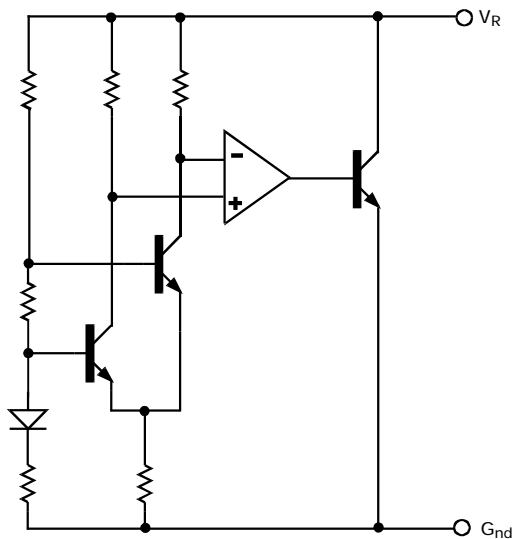

APPLICATIONS CIRCUIT

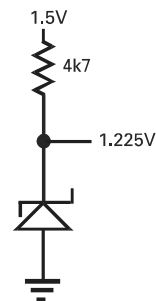

Low quiescent reference from a 1.5V battery source.

ZXRE4041

ABSOLUTE MAXIMUM RATINGS

Reverse Current	30mA
Forward Current	10mA
Operating temperature.	-40 to 85°C
Storage temperature.	-55 to 125°C

Power Dissipation (T _{amb} =25°C)	
SOT23	330mW
SO8	625mW
E-Line	500mW

ELECTRICAL CHARACTERISTICS

TEST CONDITIONS (Unless otherwise stated) T_{amb}=25°C

SYMBOL	PARAMETER	CONDITIONS	LIMITS			GRADE	UNITS
			MIN	TYP	MAX		
V _R	Reverse Breakdown Voltage	I _R =100μA	1.214 1.208 1.196 1.183	1.225 1.225 1.225 1.225	1.226 1.232 1.244 1.257	C ‡ D E F	V
I _{MIN}	Minimum Knee Current				30		μA
I _R	Recommended Operating Current Range		0.03		12		mA
T _C †	Average Reverse Breakdown Voltage Temperature Coefficient	I _{R(min)} to I _{R(max)}		20	75		ppm/°C
$\frac{\Delta V_R}{\Delta I_R}$	Reverse Breakdown Voltage change with Current	I _R =30μA to 1mA I _R =1mA to 12mA			1 10		mV mV
Z _R	Reverse Dynamic Impedance	I _R = 1mA f = 100Hz I _{AC} =0.1 I _R		0.2	0.6		Ω
E _N	Wideband Noise Voltage	I _R =8μA to 100μA f=10Hz to 10kHz		60			μV(rms)

$$\dagger T_C = \frac{(V_{R(max)} - V_{R(min)}) \times 1000000}{V_R \times (T_{(max)} - T_{(min)})}$$

Note: V_{R(max)} - V_{R(min)} is the maximum deviation in reference voltage measured over the full operating temperature range.

‡ Note: C grade SOT23 only.

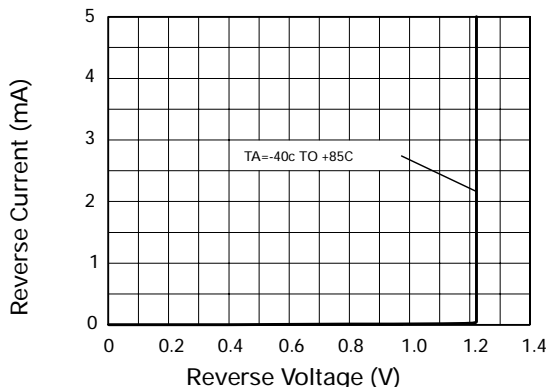

Reverse Characteristics



ISSUE 2 - JULY 1999

TYPICAL CHARACTERISTICS

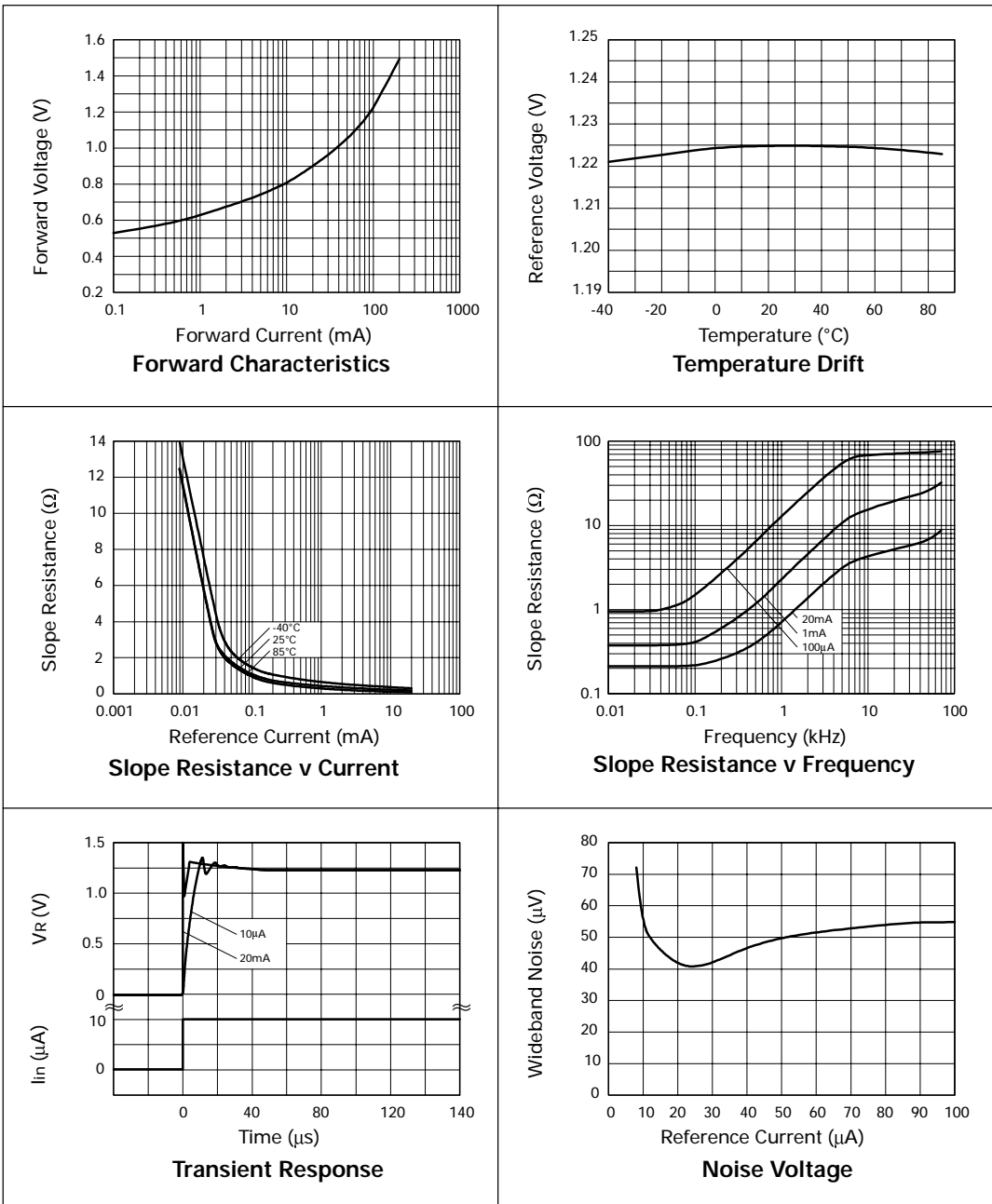

ZXRE4041

Ordering Information

Device	TOL%	Grade	Package	Partmarking
ZXRE4041CF	0.5	C	SOT23	10J
ZXRE4041DF	1	D	SOT23	10H
ZXRE4041EF	2	E	SOT23	10G
ZXRE4041FF	3	F	SOT23	10F
ZXRE4041DN8 †	1	D	SO8	ZXRE4041D
ZXRE4041EN8 †	2	E	SO8	ZXRE4041E
ZXRE4041FN8 †	3	F	SO8	ZXRE4041F
ZXRE4041DR †	1	D	E-Line	ZXRE4041D
ZXRE4041ER †	2	E	E-Line	ZXRE4041E
ZXRE4041FR †	3	F	E-Line	ZXRE4041F

†Contact Zetex marketing for availability of these package options

NOTE:

for tape and reel options add suffix TA to the part number
eg ZXRE4041DFTA

Connection Diagrams

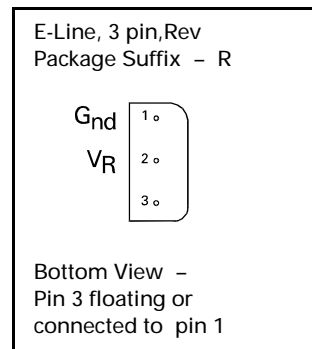
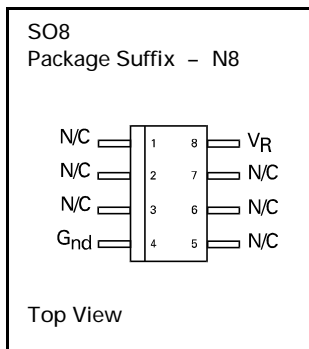
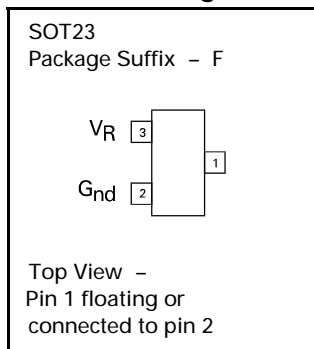

Zetex plc.
Fields New Road, Chadderton, Oldham, OL9-8NP, United Kingdom.
Telephone: (44)161 622 4422 (Sales), (44)161 622 4444 (General Enquiries)
Fax: (44)161 622 4420

Zetex GmbH
Streitfeldstraße 19
D-81673 München
Germany
Telefon: (49) 89 45 49 49 0
Fax: (49) 89 45 49 49 49

Zetex Inc.
47 Mall Drive, Unit 4
Commack NY 11725
USA
Telephone: (516) 543-7100
Fax: (516) 864-7630

Zetex (Asia) Ltd.
3510 Metroplaza, Tower 2
Hing Fong Road,
Kwai Fong, Hong Kong
Telephone: (852) 26100 611
Fax: (852) 24250 494

These are supported by
agents and distributors in
major countries world-wide
©Zetex plc 1999

Internet: <http://www.zetex.com>

This publication is issued to provide outline information only which (unless agreed by the Company in writing) may not be used, applied or reproduced for any purpose or form part of any order or contract or be regarded as a representation relating to the products or services concerned. The Company reserves the right to alter without notice the specification, design, price or conditions of supply of any product or service.