

AN-2056 LM3492 Evaluation Board Reference Design

1 Introduction

The LM3492 integrates a boost converter and a two-channel current regulator to implement a high efficient and cost effective LED driver for driving two individually dimmable LED strings with a maximum power of 15W and an output voltage of up to 65V. The boost converter employs a proprietary Projected-On-Time control method to give a fast transient response with no compensation required, and a nearly constant switching frequency programmable from 200 kHz to 1 MHz. The application circuit is stable with ceramic capacitors and produces no audible noise on dimming. The programmable peak current limit and soft-start features reduce current surges at startup, and an integrated 190 mΩ, 3.9A N-Channel MOSFET switch minimizes the solution size. The fast slew rate current regulator allows high frequency and narrow pulse width dimming signals to achieve a very high contrast ratio of 1000:1 at a dimming frequency of more than 3 kHz. The LED current is programmable from 50 mA to 200 mA by a single resistor.

To maximize the efficiency, Dynamic Headroom Control (DHC) automatically adjusts the output voltage to a minimum. DHC also facilitates a single BOM for different number of LED in a string, which is required for backlight panels of different size, thereby reducing overall development time and cost. The LM3492 comes with a versatile COMM pin which serves as a bi-directional I/O pin interfacing with an external MCU for the following functions: power-good, over-temperature, IOUT over- and under-voltage indications, switching frequency tuning, and channel 1 disabling. Other supervisory functions of the LM3492 include precise enable, VCC under-voltage lock-out, current regulator Over-Power protection, and thermal shutdown protection. The LM3492 is available in the thermally enhanced HTSSOP-20 package.

This user's guide details the design of a LM3492 evaluation board that drives 2 LED strings, each of which consists of 10 LEDs running at 150 mA and the forward voltage of each LED is typically 3.8V. The input voltage is from 9V to 16V. The evaluation board schematic, PCB layout, Bill of Materials, and circuit design descriptions are included. Typical performance and operating waveforms are also provided for reference.

Table 1. Evaluation Board Performance Characteristic

Description	Symbol	Condition	Min	Typ	Max	Unit
Input Voltage	V_{IN}		9	12	16	V
Rail Voltage	V_{OUT}			39		V
LED Current	I_{LED}			150		mA
LED Current Regulation	ΔI_{LED}	ALL V_{IN} conditions	-3		+3	%
Efficiency		$V_{IN} = 9V$		85.7		%
		$V_{IN} = 12V$		88.2		%
		$V_{IN} = 16V$		89.1		%

2 Evaluation Board Schematic

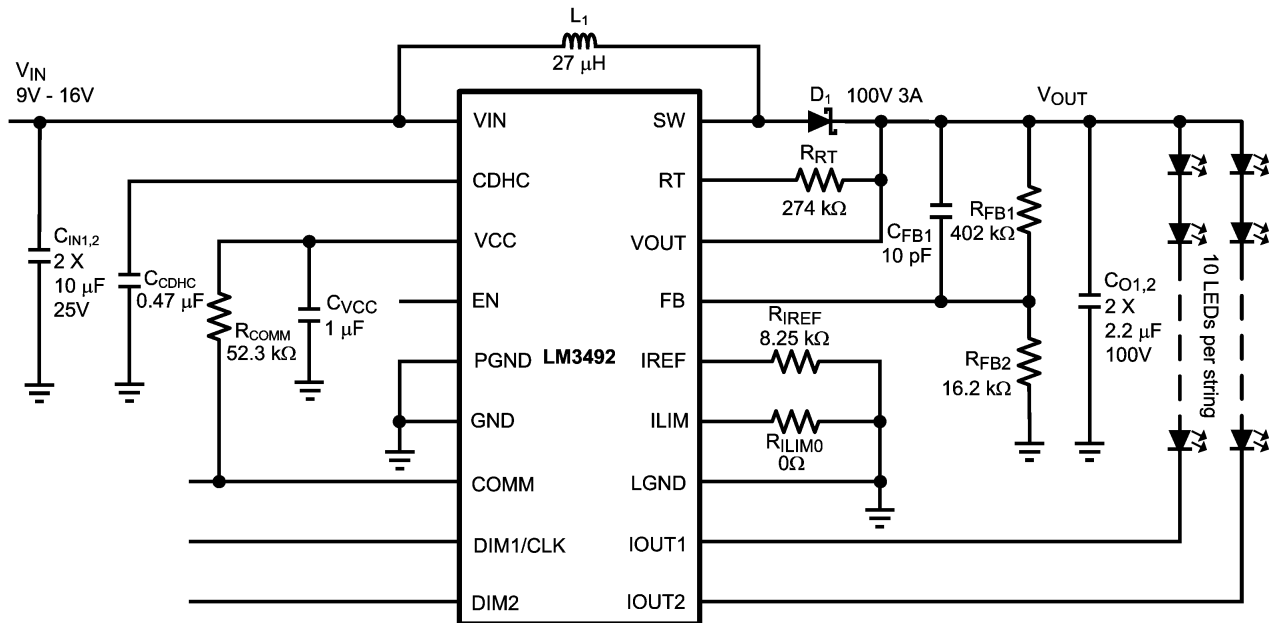

Figure 1. LM3492 Evaluation Board Schematic

3 Quick Setup Procedure

Step 1: Connect a power supply to VIN and PGND terminals. V_{IN} range: 9V to 16V.

Step 2: Connect 2 LED strings: from VLED1 to IOUT1 terminals, and VLED2 to IOUT2 terminals. Each LED string consists of 10 LEDs with a forward voltage of 3.8V per LED at 150 mA.

Step 3: The EN terminal should be left open for normal operation. Ground this terminal to shutdown.

Step 4: Connect DIM1 and DIM2 terminals to a voltage >2V, apply $V_{IN} = 12V$. Nominal LED current is 150 mA per channel.

Step 5: Ground the EN terminal to check the shutdown function.

4 Design Procedure

The following procedures detail the design of the LM3492 evaluation board driving 2 LED strings consists of 10 LEDs per string. The forward voltage of each LED is 3.8V, and the LED current is 150 mA. The input voltage is ranged from 9V to 16V. The switching frequency f_{SW} is designed to be 500 kHz.

Design Parameters:

$$V_{IN} = 9V \text{ to } 16V, \text{ typical } 12V$$

$$I_{LED} = 150 \text{ mA}$$

Step 1: Calculate the output voltage feedback circuit

The nominal voltage of the LED string with 10 LEDs is 38V, and the minimum voltage of the IOUTn pin ($n = 1, 2$) is 0.75V for an I_{LED} of 150 mA. Hence, $V_{OUT(NOM)}$ is 38.75V. Since the dynamic range of V_{FB} under DHC is from 1.05V to 2V, the nominal voltage on the FB pin $V_{FB(NOM)}$ is designed to be around 1.5V. Hence, $V_{OUT(MAX)}$ is designed to be 65V. Since:

$$V_{OUT(MAX)} = 2.5V (1 + R_{FB1} / R_{FB2}) \quad (1)$$

By designing R_{FB2} to be 16.2 kΩ, R_{FB1} is calculated to be 405 kΩ, and a standard resistor value of 402 kΩ is selected. C_{FB1} is selected to be 10 pF as recommended.

Step 2: Determine the inductance

The main parameter affected by the inductor is the peak to peak inductor current ripple (I_{LR}). To maintain a continuous conduction mode (CCM) operation, the average inductor current I_{L1} should be larger than half of I_{LR} .

For a boost converter, I_{L1} equals to the input current I_{IN} . The minimum I_{IN} occurs when V_{IN} is maximum, which is 16V in this example, and only 1 LED string is turned on (the 2 LED strings are individually dimmable). Hence,

$$I_{IN(MIN)} = (V_{OUT(NOM)} \times I_{LED}) / V_{IN(MAX)} \quad (2)$$

Also

$$t_{on} = (1 - V_{IN}/V_{OUT}) / f_{SW} \quad (3)$$

To ensure a CCM operation,

$$L_1 = (V_{IN(MAX)} \times t_{on}) / 2I_{IN(MIN)} \quad (4)$$

It can be calculated that $I_{IN(MIN)}$, t_{on} , and L_1 are 0.363A, 1.17 μ s, and 25.8 μ H. On the other hand, I_{IN} is maximum when V_{IN} is minimum, which is 9V in this example, and 2 LED strings are turned on. Hence $I_{IN(MAX)}$ is 1.29A. From Equation 3, t_{on} is 1.54 μ s when V_{IN} is 9V. Then I_{LR} is

$$I_{LR} = (V_{IN} \times t_{on}) / L_1 \quad (5)$$

From Equation 5, I_{LR} is 0.53A. The steady state peak inductor current $I_{L1(PEAK)}$ is

$$I_{L1(PEAK)} = I_{L1} + I_{LR} / 2 \quad (6)$$

As a result, $I_{L1(PEAK)}$ is 1.56A. A standard value of 27 μ H is selected for L_1 , and the saturation current of L_1 should be larger than 1.56A.

Step 3: Determine the diode

The selection of the boost diode D_1 depends on two factors. The first factor is the reverse voltage, which equals to V_{OUT} in a boost converter. The second factor is the peak diode current at the steady state, which equals to the peak inductor current as shown in Equation 6. In this example, a 100V 3A Schottky diode is selected.

Step 4: Determine the value of other components

C_{IN} and C_{OUT} : The function of the input capacitor C_{IN} and the output capacitor C_{OUT} is to reduce the input and output voltage ripples. Experimentation is usually necessary to determine their value. The rated DC voltage of capacitors used should be higher than the maximum DC voltage applied.

Owing to the concern of product lifetime, ceramic capacitors are recommended. But ceramic capacitors with high rated DC voltage and high capacitance are rare in general. Multiple capacitors connecting in parallel can be used for C_{IN} and C_{OUT} . In this example, two 10 μ F 25V ceramic capacitor are used for C_{IN} , and two 2.2 μ F 100V ceramic capacitor are used for C_{OUT} .

C_{VCC} : The capacitor on the VCC pin provides noise filtering and stabilizes the LDO regulator. It also prevents false triggering of the VCC UVLO. C_{VCC} is recommended to be a 1 μ F good quality and low ESR ceramic capacitor.

C_{CDHC} : The capacitor at the CDHC pin mainly determines the soft-start time t_{SS} , i.e. the time for the output voltage to reach its maximum. t_{SS} is determined from the following equation:

$$t_{SS} = \frac{C_{CDHC} \times 2.25V}{120 \mu A} \quad (7)$$

In this example, C_{CDHC} is recommended to be a 0.47 μ F good quality and low ESR ceramic capacitor.

R_{RT} and R_{REF} : The resistors R_{RT} and R_{REF} set the switching frequency f_{SW} of the boost converter and the LED current I_{LED} respectively. From *LM3492/LM3492Q Two-Channel Individual Dimmable LED Driver with Boost Converter and Fast Current Regulator (SNVS656)*, R_{RT} is selected to be 274 k Ω if f_{SW} is 500 kHz (Figure 1 of the datasheet (SNVS656)), and R_{REF} is selected to be 8.25 k Ω if I_{LED} is 150 mA (Figure 4 of the datasheet (SNVS656)).

R_{COMM} : Since the COMM pin is open drain, a resistor R_{COMM} of 52.3 k Ω is used to connect the VCC and COMM pins to implement a pull-up function.

5 PC Board Layout

The layout of the printed circuit board is critical to optimize the performance of the LM3492 application circuit. In general, external components should be placed as close to the LM3492 and each other as possible in order to make copper traces short and direct. In particular, components of the boost converter C_{IN} , L_1 , D_1 , C_{OUT} , and the LM3492 should be closed. Also, the output feedback capacitor C_{FB1} should be closed to the output capacitor C_{OUT} . The ground plane connecting the GND, PGND, and LGND pins and the exposed pad of the LM3492 and the ground connection of the C_{IN} and C_{OUT} should be placed on the same copper layer.

Good heat dissipation helps optimize the performance of the LM3492. The ground plane should be used to connect the exposed pad of the LM3492, which is internally connected to the LM3492 die substrate. The area of the ground plane should be extended as much as possible on the same copper layer around the LM3492. Using numerous vias beneath the exposed pad to dissipate heat of the LM3492 to another copper layer is also a good practice.

6 Bill of Materials

Item	Part Number	Mfg name	Part Description	Qty	Ref Designator(s)	Size
1	GRM31CR61E106KA12L	muRata	Cap 10 μ F 25V X5R	2	C_{IN1} , C_{IN2}	1206
2	GRM188R71C474KA88D	muRata	0603/X7R/0.47 μ F/16V	1	C_{CDHC}	0603
3	GRM1885C2A100RA01D	muRata	0603/COG/10 pF/100V	1	C_{FB1}	0603
4	GRM188R71C105KA12D	muRata	0603/X7R/1 μ F/16V	1	C_{VCC}	0603
5	GRM32ER72A225KA35L	muRata	Cap 2.2 μ F 100V X7R	2	C_{O1} , C_{O2}	1210
6	CRCW060352K3FKEA	Vishay	Resistor Chip 52.3 k Ω 1%	1	R_{COMM}	0603
7	CRCW0603274KFKEA	Vishay	Resistor Chip 274 k Ω 1%	1	R_{RT}	0603
8	CRCW0603402KFKEA	Vishay	Resistor Chip 402 k Ω 1%	1	R_{FB1}	0603
9	CRCW060316K2FKEA	Vishay	Resistor Chip 16.2 k Ω 1%	1	R_{FB2}	0603
10	CRCW06038K25FKEA	Vishay	Resistor Chip 8.25 k Ω 1%	1	R_{REF}	0603
11	CRCW06030000Z0EA	Vishay	Resistor Chip 0 Ω 1%	1	R_{LIM0}	0603
12	CDRH10D68/ANP-270MC	Sumida	Inductor 27 μ H 1.9A	1	L_1	10x10x6.8
13	SK310A-TP	Micro Commercial	Schottky 100V 3A	1	D_1	SMA
14	1502-2k-ND	KEYSTONE	Terminal DBL Turret 0.109"L Brass	11	VIN, GND, PGND, VLED1, VLED2, IOUT1, IOUT2, DIM1, DIM2, COMM, EN	
15	LM3492EVAL	Texas Instruments	LM3492 demo board	1	PCB	
16	LM3492	Texas Instruments	IC LM3492	1	U1	HTSSOP- 20

7 Typical Performance and Waveforms

All curves and waveforms taken at $V_{IN} = 12V$ with the evaluation board and $T_A = 25^\circ C$ unless otherwise specified.

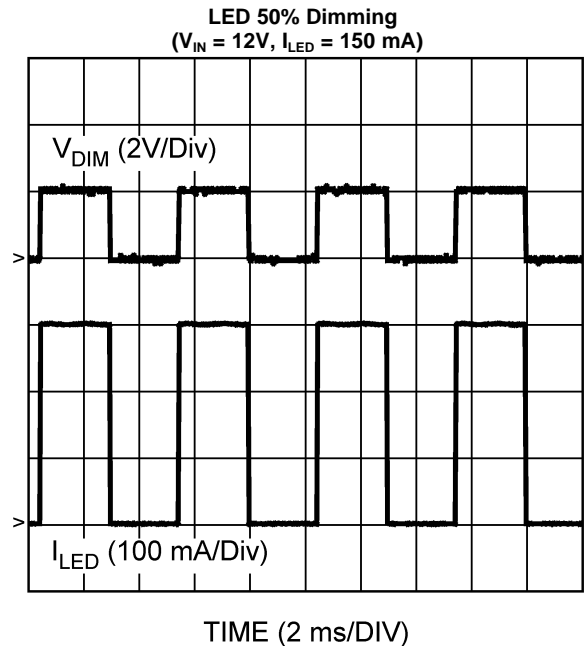
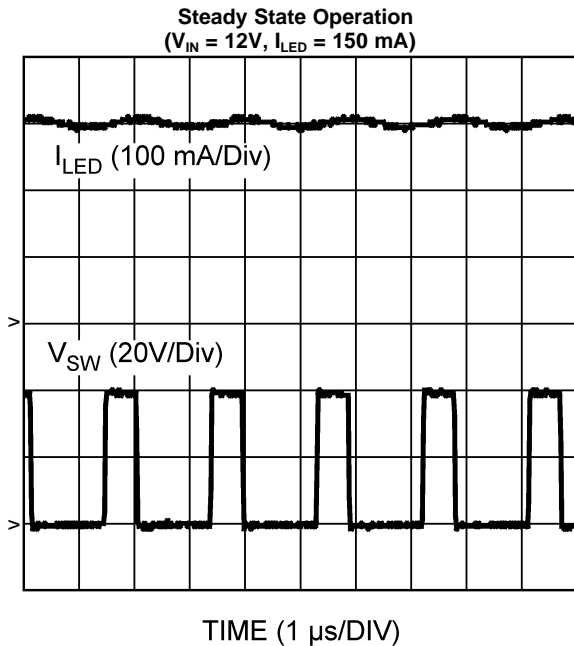
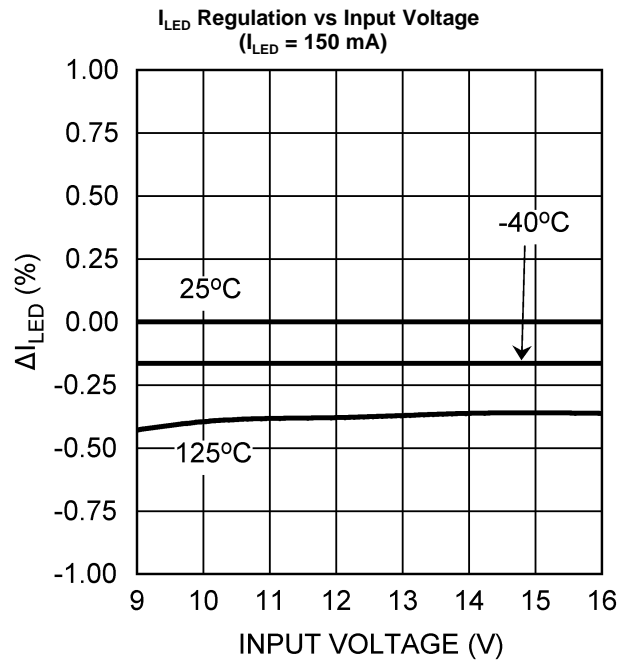
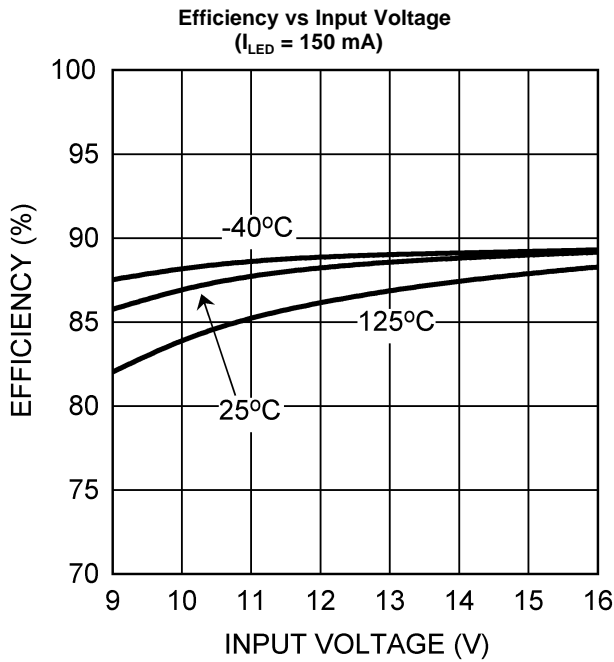

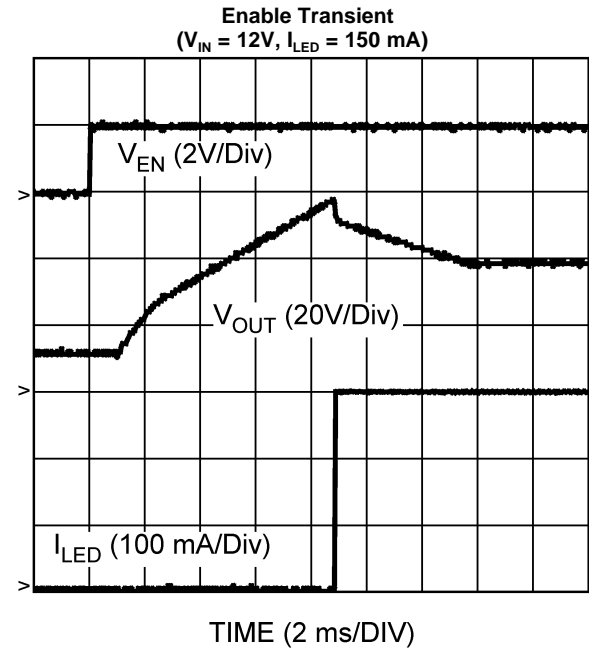
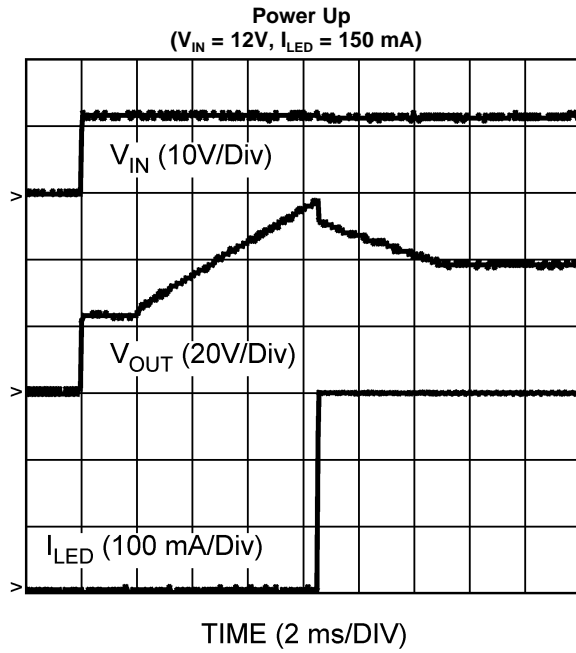

8 PCB Layout

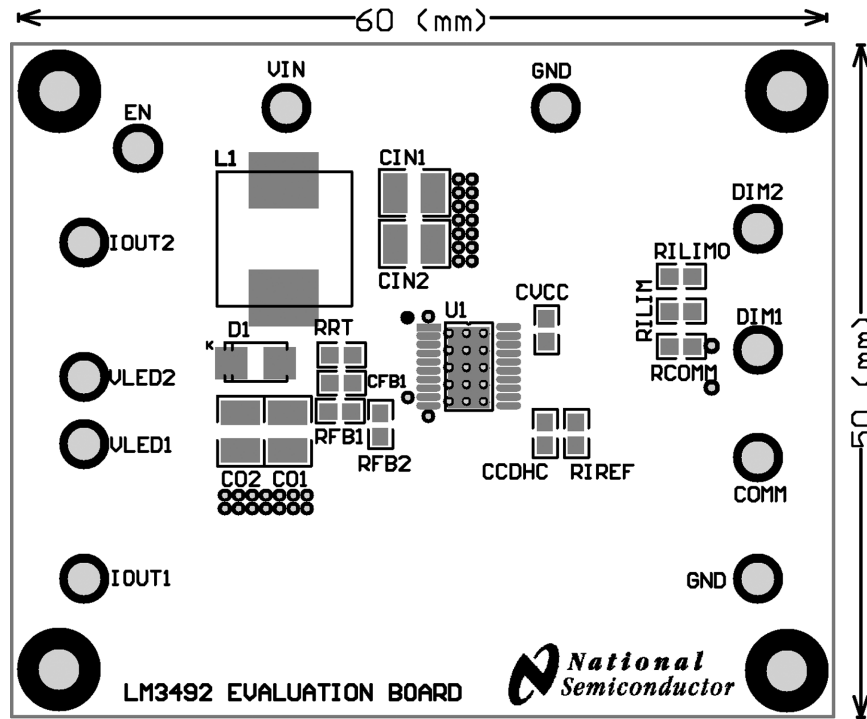

Figure 2. LM3492 Evaluation Board Top Overlay

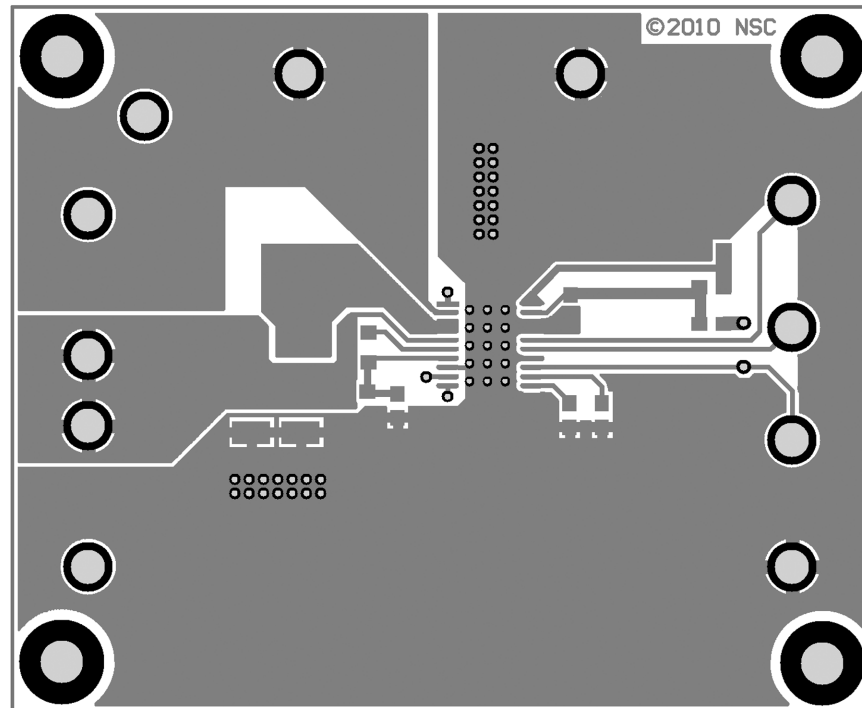

Figure 3. LM3492 Evaluation Board Top View

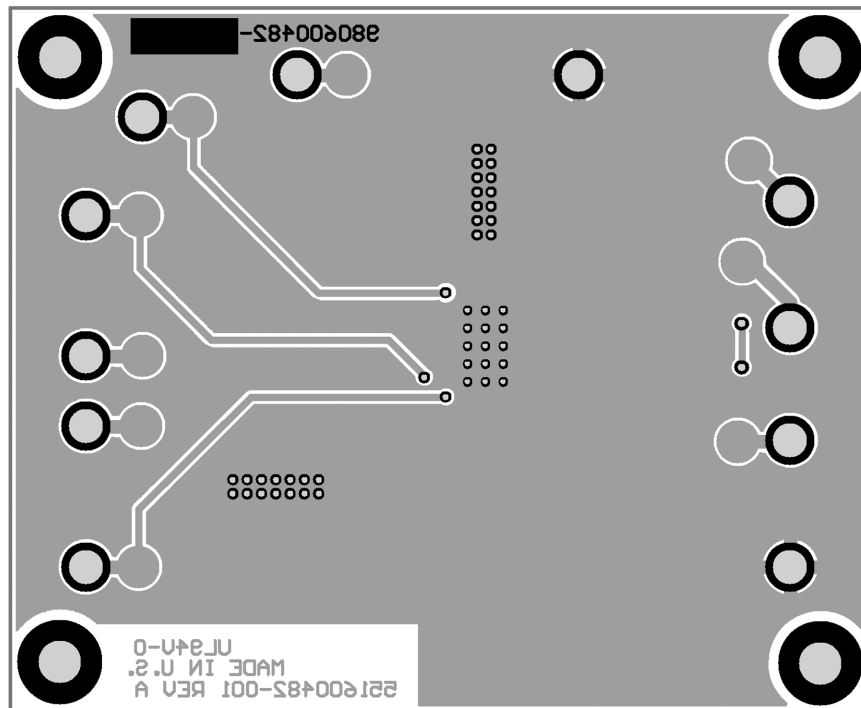

Figure 4. LM3492 Evaluation Board Bottom View

IMPORTANT NOTICE

Texas Instruments Incorporated and its subsidiaries (TI) reserve the right to make corrections, enhancements, improvements and other changes to its semiconductor products and services per JESD46, latest issue, and to discontinue any product or service per JESD48, latest issue. Buyers should obtain the latest relevant information before placing orders and should verify that such information is current and complete. All semiconductor products (also referred to herein as "components") are sold subject to TI's terms and conditions of sale supplied at the time of order acknowledgment.

TI warrants performance of its components to the specifications applicable at the time of sale, in accordance with the warranty in TI's terms and conditions of sale of semiconductor products. Testing and other quality control techniques are used to the extent TI deems necessary to support this warranty. Except where mandated by applicable law, testing of all parameters of each component is not necessarily performed.

TI assumes no liability for applications assistance or the design of Buyers' products. Buyers are responsible for their products and applications using TI components. To minimize the risks associated with Buyers' products and applications, Buyers should provide adequate design and operating safeguards.

TI does not warrant or represent that any license, either express or implied, is granted under any patent right, copyright, mask work right, or other intellectual property right relating to any combination, machine, or process in which TI components or services are used. Information published by TI regarding third-party products or services does not constitute a license to use such products or services or a warranty or endorsement thereof. Use of such information may require a license from a third party under the patents or other intellectual property of the third party, or a license from TI under the patents or other intellectual property of TI.

Reproduction of significant portions of TI information in TI data books or data sheets is permissible only if reproduction is without alteration and is accompanied by all associated warranties, conditions, limitations, and notices. TI is not responsible or liable for such altered documentation. Information of third parties may be subject to additional restrictions.

Resale of TI components or services with statements different from or beyond the parameters stated by TI for that component or service voids all express and any implied warranties for the associated TI component or service and is an unfair and deceptive business practice. TI is not responsible or liable for any such statements.

Buyer acknowledges and agrees that it is solely responsible for compliance with all legal, regulatory and safety-related requirements concerning its products, and any use of TI components in its applications, notwithstanding any applications-related information or support that may be provided by TI. Buyer represents and agrees that it has all the necessary expertise to create and implement safeguards which anticipate dangerous consequences of failures, monitor failures and their consequences, lessen the likelihood of failures that might cause harm and take appropriate remedial actions. Buyer will fully indemnify TI and its representatives against any damages arising out of the use of any TI components in safety-critical applications.

In some cases, TI components may be promoted specifically to facilitate safety-related applications. With such components, TI's goal is to help enable customers to design and create their own end-product solutions that meet applicable functional safety standards and requirements. Nonetheless, such components are subject to these terms.

No TI components are authorized for use in FDA Class III (or similar life-critical medical equipment) unless authorized officers of the parties have executed a special agreement specifically governing such use.

Only those TI components which TI has specifically designated as military grade or "enhanced plastic" are designed and intended for use in military/aerospace applications or environments. Buyer acknowledges and agrees that any military or aerospace use of TI components which have **not** been so designated is solely at the Buyer's risk, and that Buyer is solely responsible for compliance with all legal and regulatory requirements in connection with such use.

TI has specifically designated certain components as meeting ISO/TS16949 requirements, mainly for automotive use. In any case of use of non-designated products, TI will not be responsible for any failure to meet ISO/TS16949.

Products

Audio	www.ti.com/audio
Amplifiers	amplifier.ti.com
Data Converters	dataconverter.ti.com
DLP® Products	www.dlp.com
DSP	dsp.ti.com
Clocks and Timers	www.ti.com/clocks
Interface	interface.ti.com
Logic	logic.ti.com
Power Mgmt	power.ti.com
Microcontrollers	microcontroller.ti.com
RFID	www.ti-rfid.com
OMAP Applications Processors	www.ti.com/omap
Wireless Connectivity	www.ti.com/wirelessconnectivity

Applications

Automotive and Transportation	www.ti.com/automotive
Communications and Telecom	www.ti.com/communications
Computers and Peripherals	www.ti.com/computers
Consumer Electronics	www.ti.com/consumer-apps
Energy and Lighting	www.ti.com/energy
Industrial	www.ti.com/industrial
Medical	www.ti.com/medical
Security	www.ti.com/security
Space, Avionics and Defense	www.ti.com/space-avionics-defense
Video and Imaging	www.ti.com/video

TI E2E Community

e2e.ti.com