

# NCN9252

## High-Speed USB 2.0 (480 Mbps) DP3T Switch for USB/UART/Data Multiplexing

### Brief Description

The NCN9252 is a DP3T switch for combined UART and USB 2.0 high-speed data applications. It allows portable systems to use a single external port to transmit and receive signals to and from three separate locations within the portable system. It is comprised of two switches, each with a single common I/O that alternates between 3 terminals. They are operated together to allow three data sources, such as a USB or UART transceiver, to pass differential data through a shared USB connector port.

The NCN9252 features low  $R_{ON}$ — 4  $\Omega$  (max) at 4.2 V  $V_{CC}$ , 5  $\Omega$  (typ) at a 3.3 V  $V_{CC}$ . It also features low  $C_{ON}$ , < 30 pF (max) across the supply voltage range. This performance makes it ideal for both USB full-speed and high-speed applications that require both low  $R_{ON}$  and  $C_{ON}$  for effective signal transmission.

The NCN9252 is capable of accepting control input signals down to 1.4 V, over a range of  $V_{CC}$  supply voltages with minimal leakage current. The NCN9252 is offered in a Pb-Free, 12 pin, 1.7 x 2.0 x 0.5 mm, UQFN package. An Evaluation Board specifically designed for the NCN9252 is available and features USB connectors and test points to allow straightforward testing of the device. Please see part number NCN9252MUGEVB.

### Features

- USB 2.0 Signal Routing
- -3 dB Bandwidth: 525 MHz
- $R_{ON}$ : 4  $\Omega$  Max @  $V_{CC}$  = 4.2 V
- $C_{ON}$ : < 20 pF @  $V_{CC}$  = 3.3 V
- OVT Protection up to 5.25 V on Common Pins
- $V_{CC}$  Range: 1.65 V to 4.5 V
- 3 kV ESD Protection
- 1.7 x 2.0 x 0.5 mm UQFN12 Package
- This is a Pb-Free Device

### Typical Applications

- USB/UART/Data Multiplexing
- Shared USB Connector
- Mobile Phones
- Portable Devices



ON Semiconductor®

<http://onsemi.com>



1  
UQFN12  
MU SUFFIX  
CASE 523AE

### MARKING DIAGRAM

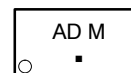

AD = Specific Device Code  
M = Date Code  
▪ = Pb-Free Package

### APPLICATION DIAGRAM

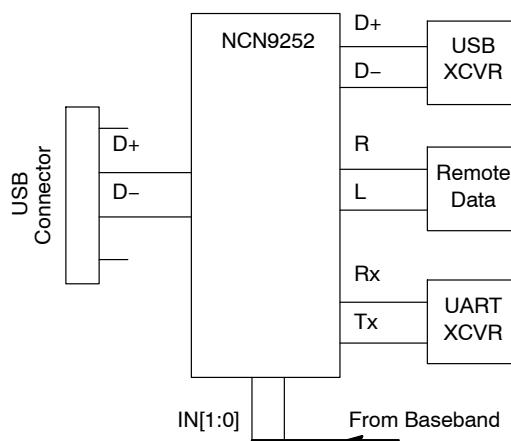

### ORDERING INFORMATION

| Device       | Package             | Shipping†             |
|--------------|---------------------|-----------------------|
| NCN9252MUTAG | UQFN12<br>(Pb-Free) | 3000 /<br>Tape & Reel |

†For information on tape and reel specifications, including part orientation and tape sizes, please refer to our Tape and Reel Packaging Specification Brochure, BRD8011/D.

# NCN9252

## FUNCTIONAL BLOCK DIAGRAM AND PINOUT

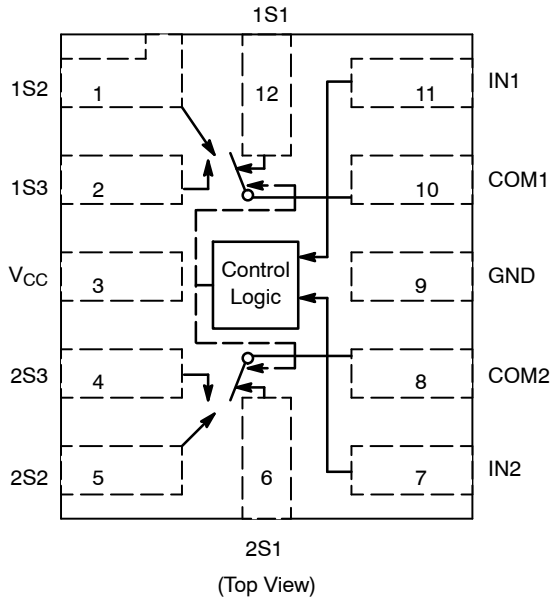

Figure 1. Internal Block Diagram

### PIN DESCRIPTIONS

| Pin# | Name            | Direction | Description                      |
|------|-----------------|-----------|----------------------------------|
| 1    | 1S2             | I/O       | Switch #1 Position 2 Signal Line |
| 2    | 1S3             | I/O       | Switch #1 Position 3 Signal Line |
| 3    | V <sub>CC</sub> | Input     | Power Supply                     |
| 4    | 2S3             | I/O       | Switch #2 Position 3 Signal Line |
| 5    | 2S2             | I/O       | Switch #2 Position 2 Signal Line |
| 6    | 2S1             | I/O       | Switch #2 Position 1 Signal Line |
| 7    | IN2             | Input     | Bit 1 Control Input Select Line  |
| 8    | COM2            | I/O       | Switch #2 Common Signal Line     |
| 9    | GND             | Input     | Ground                           |
| 10   | COM1            | I/O       | Switch #1 Common Signal Line     |
| 11   | IN1             | Input     | Bit 0 Control Input Select Line  |
| 12   | 1S1             | I/O       | Switch #1 Position 1 Signal Line |

### FUNCTION TABLE

| IN1 [0] | IN2 [1] | COM1 Closed to: | COM2 Closed to: |
|---------|---------|-----------------|-----------------|
| 0       | 0       | No Connect      | No Connect      |
| 1       | 0       | 1S1             | 2S1             |
| 0       | 1       | 1S2             | 2S2             |
| 1       | 1       | 1S3             | 2S3             |

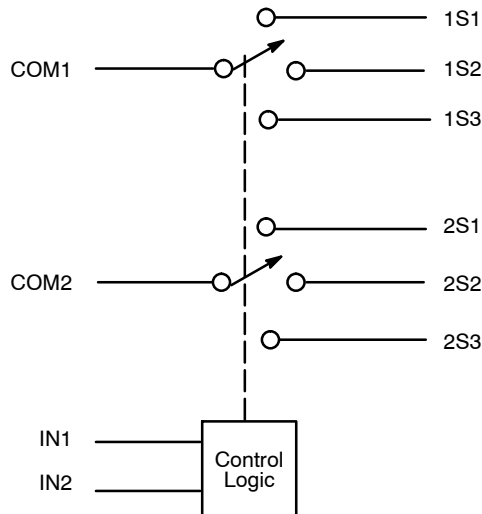

Figure 2. Functional Block Diagram

**OPERATING CONDITIONS**

**MAXIMUM RATINGS**

| Symbol              | Pins             | Parameter                        | Value                         | Condition      | Unit |
|---------------------|------------------|----------------------------------|-------------------------------|----------------|------|
| V <sub>CC</sub>     | V <sub>CC</sub>  | Positive DC Supply Voltage       | -0.5 to +5.5                  |                | V    |
| V <sub>IS</sub>     | 1Sx, 2Sx         | Analog Signal Voltage            | -0.5 to V <sub>CC</sub> + 0.3 |                | V    |
|                     | COMx             |                                  | -0.5 to 5.3                   |                |      |
| V <sub>IN</sub>     | IN1, IN2         | Control Input Voltage            | -0.5 to 4.6                   |                | V    |
| I <sub>CC</sub>     | V <sub>CC</sub>  | Positive DC Supply Current       | 50                            |                | mA   |
| I <sub>IS_CON</sub> | 1Sx, 2Sx<br>COMx | Analog Signal Continuous Current | ± 300                         | Closed Switch  | mA   |
| I <sub>IS_PK</sub>  | 1Sx, 2Sx<br>COMx | Analog Signal Peak Current       | ± 500                         | 10% Duty Cycle | mA   |
| I <sub>IN</sub>     | IN1, IN2         | Control Input Current            | ± 20                          |                | mA   |
| T <sub>STG</sub>    |                  | Storage Temperature Range        | -65 to 150                    |                | °C   |

Stresses exceeding Maximum Ratings may damage the device. Maximum Ratings are stress ratings only. Functional operation above the Recommended Operating Conditions is not implied. Extended exposure to stresses above the Recommended Operating Conditions may affect device reliability.

**RECOMMENDED OPERATING CONDITIONS**

| Symbol          | Pins            | Parameter                   | Value                  | Condition | Unit |
|-----------------|-----------------|-----------------------------|------------------------|-----------|------|
| V <sub>CC</sub> | V <sub>CC</sub> | Positive DC Supply Voltage  | 1.65 to 4.5            |           | V    |
| V <sub>IS</sub> | 1Sx, 2Sx        | Analog Signal Voltage       | GND to V <sub>CC</sub> |           | V    |
|                 | COMx            |                             | GND to 4.5             |           |      |
| V <sub>IN</sub> | IN1, IN2        | Control Input Voltage       | GND to V <sub>CC</sub> |           | V    |
| T <sub>A</sub>  |                 | Operating Temperature Range | -40 to 85              |           | °C   |

Minimum and maximum values are guaranteed through test or design across the **Recommended Operating Conditions**, where applicable. Typical values are listed for guidance only and are based on the particular conditions listed for each section, where applicable. These conditions are valid for all values found in the characteristics tables unless otherwise specified in the test conditions.

**ESD PROTECTION**

| Pins     | Description      | Minimum Voltage |
|----------|------------------|-----------------|
| All Pins | Human Body Model | 3 kV            |

DC ELECTRICAL CHARACTERISTICS

CONTROL INPUT (TYPICAL: T = 25°C; V<sub>CC</sub> = 3.3 V)

| Symbol          | Pins | Parameter             | Test Conditions       | V <sub>CC</sub>         | Min                  | Typ | Max               | Unit |
|-----------------|------|-----------------------|-----------------------|-------------------------|----------------------|-----|-------------------|------|
| V <sub>IH</sub> | INx  | Control Input High    | Figure 3              | 2.7 V<br>3.3 V<br>4.2 V | 1.25<br>1.35<br>1.50 |     |                   | V    |
| V <sub>IL</sub> | INx  | Control Input Low     | Figure 3              | 2.7 V<br>3.3 V<br>4.2 V |                      |     | 0.4<br>0.4<br>0.5 | V    |
| I <sub>IN</sub> | INx  | Control Input Leakage | V <sub>IS</sub> = GND |                         |                      |     | ± 1.0             | μA   |

SUPPLY CURRENT AND LEAKAGE (TYPICAL: T = 25°C; V<sub>CC</sub> = 3.3 V, V<sub>IN</sub> = V<sub>CC</sub> or GND)

| Symbol                   | Pins            | Parameter         | Test Conditions   | V <sub>CC</sub> | Min | Typ | Max   | Unit |
|--------------------------|-----------------|-------------------|---|-----------------|-----|-----|-------|------|
| I <sub>NO/NC</sub> (OFF) | NC, NO          | OFF State Leakage | V <sub>COM</sub> = 3.6 V<br>V <sub>NC</sub> = 1.0 V           |                 |     |     | ± 1.0 | μA   |
| I <sub>COM</sub> (ON)    | COM             | ON State Leakage  |   |                 |     |     | ± 1.0 | μA   |
| I <sub>CC</sub>          | V <sub>CC</sub> | Quiescent Supply  | V <sub>IS</sub> = V <sub>CC</sub> or GND, I <sub>D</sub> = 0; |                 |     |     | 1.0   | μA   |
| I <sub>OFF</sub>         |                 | Power OFF Leakage | V <sub>IS</sub> = GND   |                 |     |     | 1.0   | μA   |

ON RESISTANCE (TYPICAL: T = 25°C; V<sub>CC</sub> = 3.3 V)

| Symbol            | Pins          | Parameter                | Test Conditions   | V <sub>CC</sub>         | Min | Typ           | Max               | Unit |
|-------------------|---------------|--------------------------|---|-------------------------|-----|---------------|-------------------|------|
| R <sub>ON</sub>   | 1Sx, 2Sx COMx | ON Resistance            | I <sub>ON</sub> = -8 mA, V <sub>IS</sub> = 0 to V <sub>CC</sub> ; | 2.7 V<br>3.3 V<br>4.2 V |     | 5<br>4<br>3.5 | 6<br>5<br>4.5     | Ω    |
| R <sub>FLAT</sub> | 1Sx, 2Sx COMx | R <sub>ON</sub> Flatness | I <sub>ON</sub> = -8 mA, V <sub>IS</sub> = 0 to V <sub>CC</sub> ; | 2.7 V<br>3.3 V<br>4.2 V |     |               | 1.3<br>1.4<br>1.6 | Ω    |
| ΔR <sub>ON</sub>  | 1Sx, 2Sx COMx | R <sub>ON</sub> Matching | I <sub>ON</sub> = -8 mA, V <sub>IS</sub> = 0 to V <sub>CC</sub> ; | 2.7 V<br>3.3 V<br>4.2 V |     | 0.35          |                   | Ω    |

AC ELECTRICAL CHARACTERISTICS

TIMING/FREQUENCY (TYPICAL: T = 25°C; V<sub>CC</sub> = 3.3 V, R<sub>L</sub> = 50 Ω, C<sub>L</sub> = 5 pF, f = 1 MHz)

| Symbol           | Pins                      | Parameter                 | Test Conditions                      | Min | Typ  | Max | Unit |
|------------------|---------------------------|---------------------------|--------------------------------------|-----|------|-----|------|
| BW               |                           | -3 dB Bandwidth           | Power level = 0 dBm                  |     | 525  |     | MHz  |
| THD              |                           | Total Harmonic Distortion | 20 Hz to 20 kHz, 1.0 V <sub>pp</sub> |     | 0.01 |     | %    |
| t <sub>ON</sub>  | 1Sx to 1Sy,<br>2Sx to 2Sy | Turn On Time              |                                      |     | 13   | 30  | nS   |
| t <sub>OFF</sub> | 1Sy to 1Sx,<br>2Sy to 2Sx | Turn Off Time             |                                      |     | 12   | 25  | nS   |
| t <sub>BBM</sub> | 1Sx to 1Sy,<br>2Sx to 2Sy | Break Before Make         |                                      | 2.0 |      |     | nS   |

CROSSTALK: (TYPICAL: T = 25°C; V<sub>CC</sub> = 3.3V, R<sub>L</sub> = 50 Ω, C<sub>L</sub> = 35 pF, f = 1MHz)

| Symbol            | Pins         | Parameter            | Test Conditions     | Min | Typ | Max | Unit |
|-------------------|--------------|----------------------|---------------------|-----|-----|-----|------|
| O <sub>IRR</sub>  | 1Sx or 2Sx   | Off Isolation        | V <sub>IN</sub> = 0 |     | -60 |     | dB   |
| X <sub>talk</sub> | COMx to COMy | Non-Adjacent Channel |                     |     | -60 |     | dB   |

CAPACITANCE (TYPICAL: T = 25°C; V<sub>CC</sub> = 3.3V, R<sub>L</sub> = 50 Ω, C<sub>L</sub> = 5 pF, f = 1 MHz)

| Symbol           | Pins                 | Parameter       | Test Conditions                                | Min | Typ | Max | Unit |
|------------------|----------------------|-----------------|--|-----|-----|-----|------|
| C <sub>IN</sub>  | INx                  | Control Input   | V <sub>CC</sub> = 0 V                          |     | 3   |     | pF   |
| C <sub>ON</sub>  | 1Sx or 2Sx<br>to COM | Through Switch  | V <sub>CC</sub> = 3.3 V, V <sub>IN</sub> = 0 V |     | 16  | 20  | pF   |
| C <sub>OFF</sub> | 1Sx, 2Sx COMx        | Unselected Port | V <sub>CC</sub> = V <sub>IN</sub> = 3.3 V      |     | 8   |     | pF   |

# NCN9252

## Control Inputs Select Logic

The NCN9252 is made up of two, triple-throw switches operating off of the same internal enable signal. For each switch, a signal can pass from the common pin to any of three terminals. Whenever COM1 is closed to terminal 1S2, COM2 will respectively be closed to terminal 2S2. The

select logic is controlled by two inputs, IN1 and IN2, connecting the common pins to the terminals according to the function table found on page 2. Since there are four possible control states but only 3 possible terminals, the first combination results in a open connection for all three terminals.

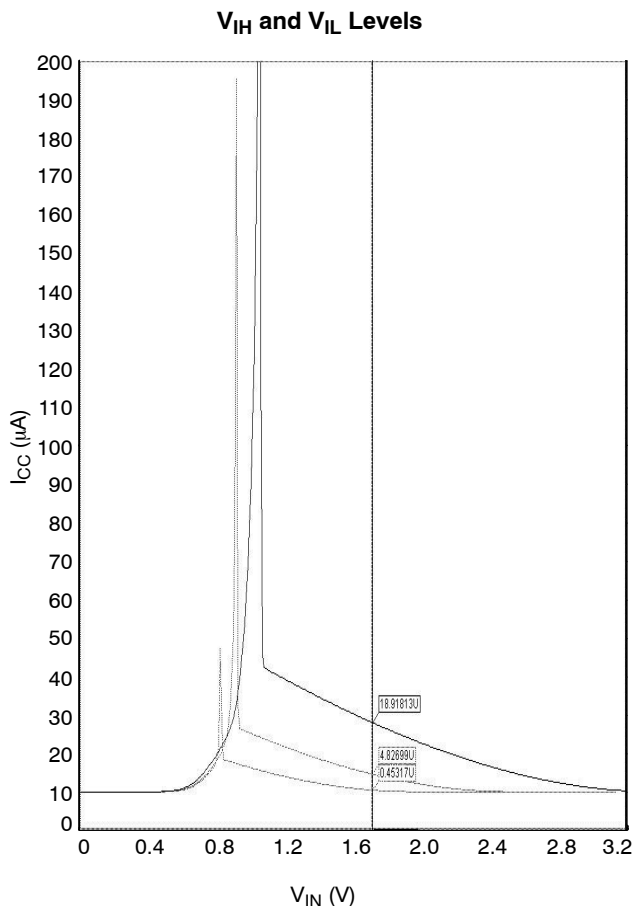

Figure 3. I<sub>CC</sub> Leakage Current vs. V<sub>IN</sub>

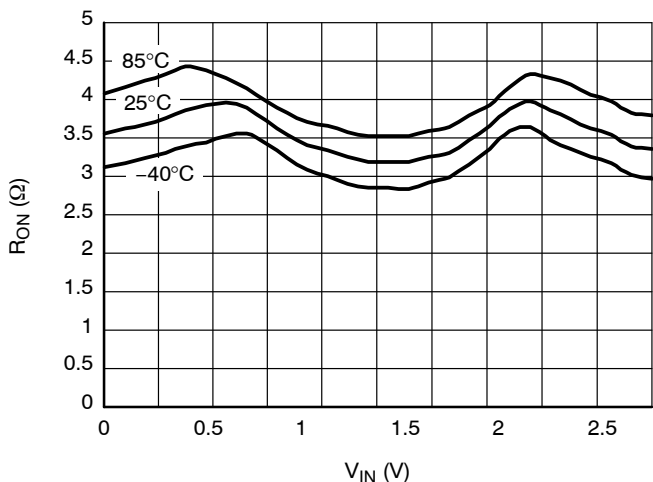

Figure 4. On-Resistance vs. Input Voltage @  $V_{CC} = 2.7\text{ V}$

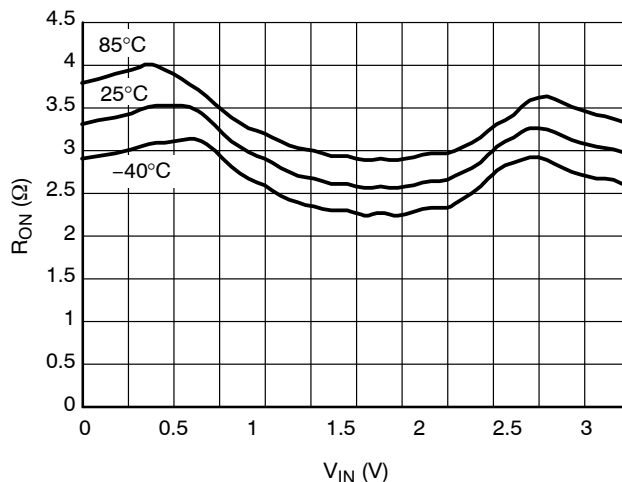

Figure 5. On-Resistance vs. Input Voltage @  $V_{CC} = 3.3\text{ V}$

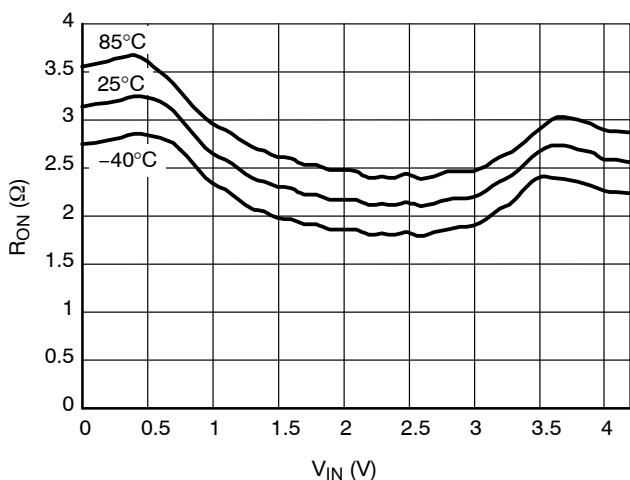

Figure 6. On-Resistance vs. Input Voltage @  $V_{CC} = 4.2\text{ V}$

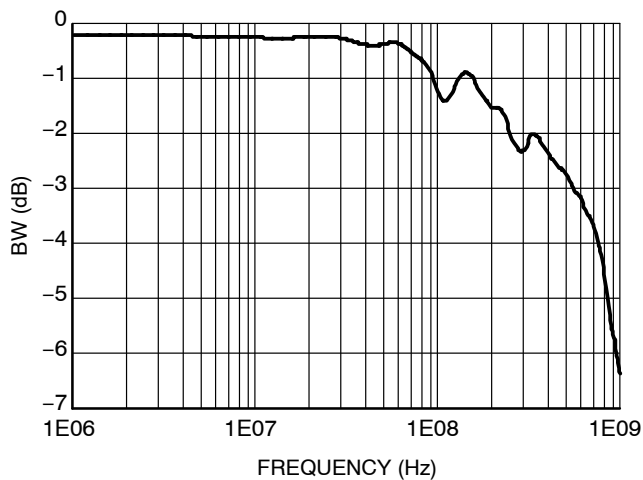

Figure 7. Bandwidth vs. Frequency

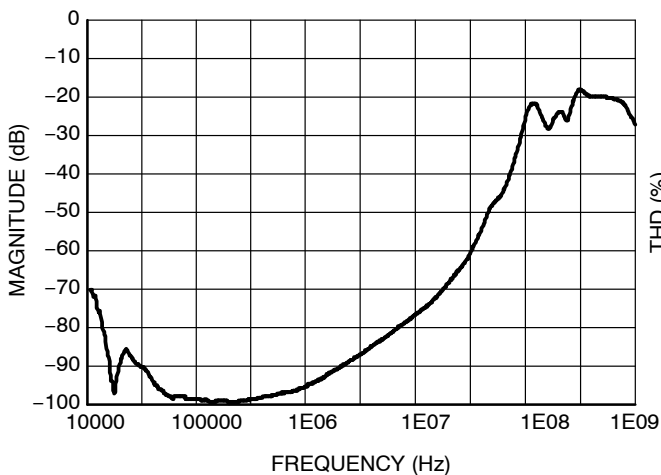

Figure 8. Cross Talk vs. Frequency @  $25^\circ\text{C}$

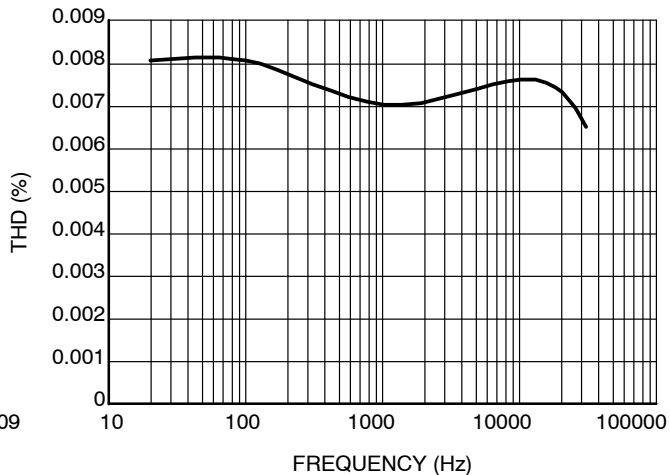

Figure 9. Total Harmonic Distortion vs. Frequency

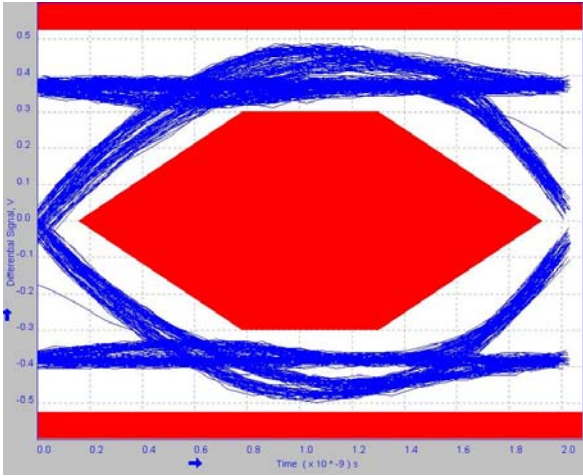

Figure 10. Channel 1S1/2S1 USB2.0 Near End Eye Diagram ( $V_{CC} = 3.3\text{ V}$ ,  $IN1 = 1$ ,  $IN2 = 0$ ,  $Temp = 25^{\circ}\text{C}$ )

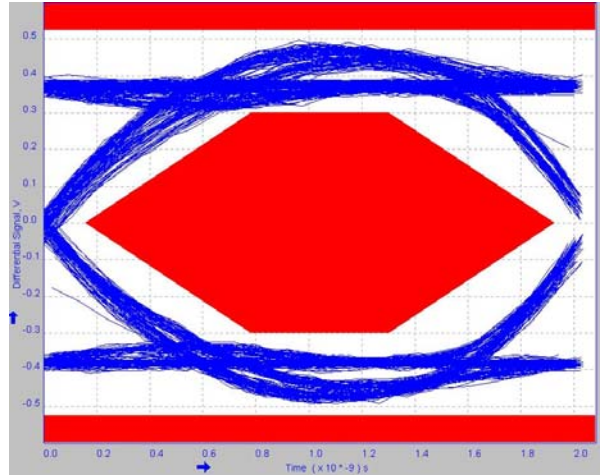

Figure 11. Channel 1S2/2S2 USB2.0 Near End Eye Diagram ( $V_{CC} = 3.3\text{ V}$ ,  $IN1 = 0$ ,  $IN2 = 1$ ,  $Temp = 25^{\circ}\text{C}$ )

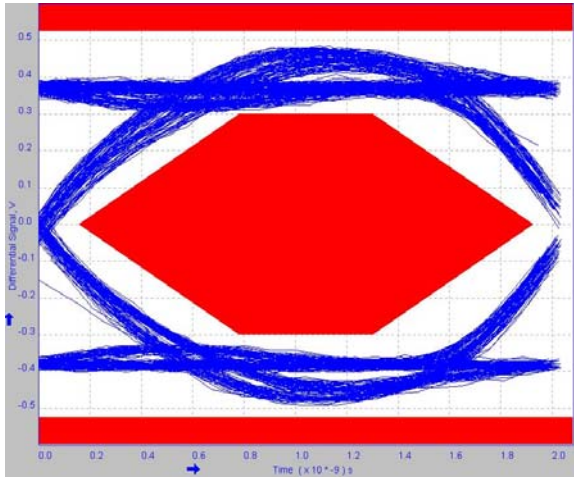

Figure 12. Channel 1S3/2S3 USB2.0 Near End Eye Diagram ( $V_{CC} = 3.3\text{ V}$ ,  $IN1 = 1$ ,  $IN2 = 1$ ,  $Temp = 25^{\circ}\text{C}$ )

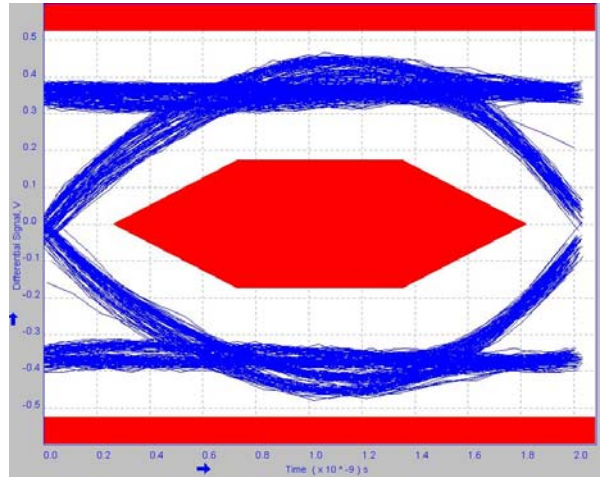

Figure 13. Channel 1S1/2S1 USB2.0 Far End Eye Diagram ( $V_{CC} = 3.3\text{ V}$ ,  $IN1 = 1$ ,  $IN2 = 0$ ,  $Temp = 25^{\circ}\text{C}$ )

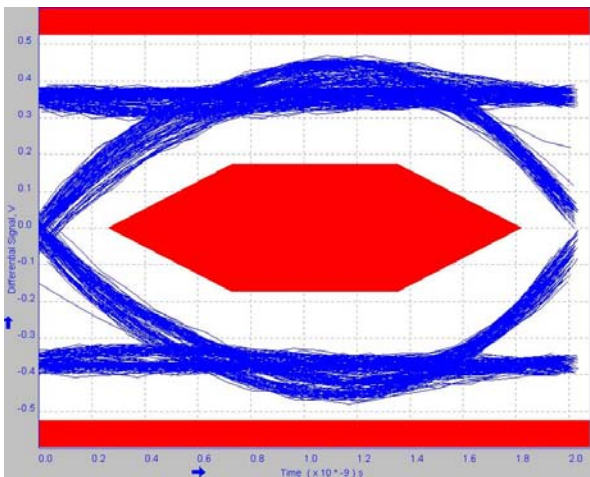

Figure 14. Channel 1S2/2S2 USB2.0 Far End Eye Diagram ( $V_{CC} = 3.3\text{ V}$ ,  $IN1 = 0$ ,  $IN2 = 1$ ,  $Temp = 25^{\circ}\text{C}$ )

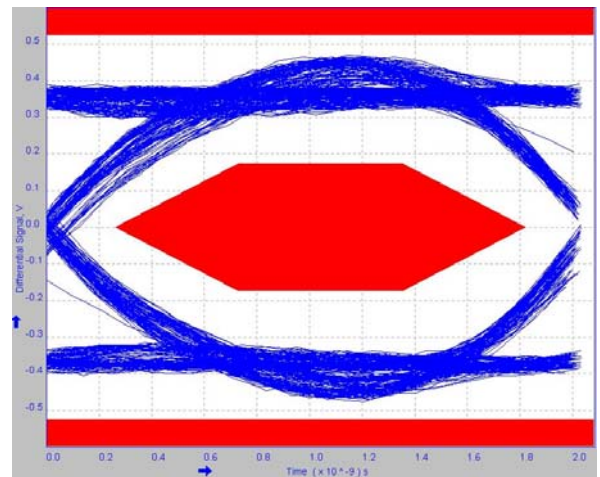

Figure 15. Channel 1S3/2S3 USB2.0 Far End Eye Diagram ( $V_{CC} = 3.3\text{ V}$ ,  $IN1 = 1$ ,  $IN2 = 1$ ,  $Temp = 25^{\circ}\text{C}$ )



# MECHANICAL CASE OUTLINE PACKAGE DIMENSIONS

ON Semiconductor®



UQFN12 1.7x2.0, 0.4P  
CASE 523AE-01  
ISSUE A

DATE 11 JUN 2007

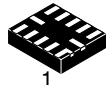

SCALE 4:1

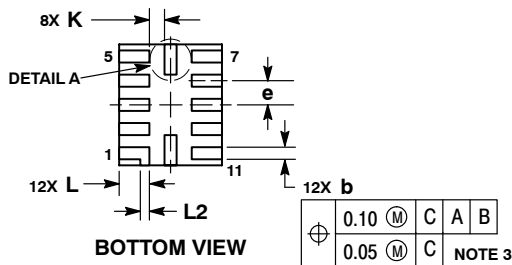
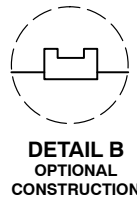
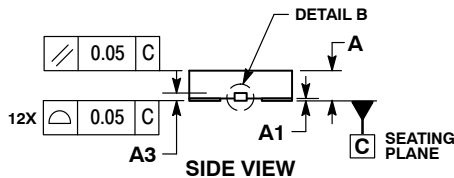
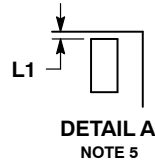
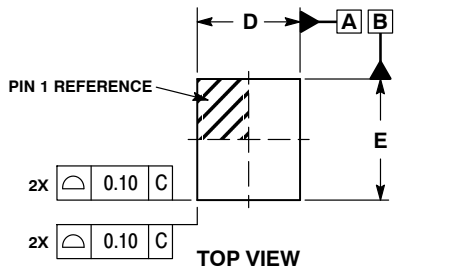

NOTES:

1. DIMENSIONING AND TOLERANCING PER ASME Y14.5M, 1994.
2. CONTROLLING DIMENSION: MILLIMETERS
3. DIMENSION b APPLIES TO PLATED TERMINAL AND IS MEASURED BETWEEN 0.15 AND 0.30 MM FROM TERMINAL TIP.
4. MOLD FLASH ALLOWED ON TERMINALS ALONG EDGE OF PACKAGE. FLASH 0.03 MAX ON BOTTOM SURFACE OF TERMINALS.
5. DETAIL A SHOWS OPTIONAL CONSTRUCTION FOR TERMINALS.

| DIM | MILLIMETERS |      |
|-----|-------------|------|
|     | MIN         | MAX  |
| A   | 0.45        | 0.55 |
| A1  | 0.00        | 0.05 |
| A3  | 0.127 REF   |      |
| b   | 0.15        | 0.25 |
| D   | 1.70 BSC    |      |
| E   | 2.00 BSC    |      |
| e   | 0.40 BSC    |      |
| K   | 0.20        | ---  |
| L   | 0.45        | 0.55 |
| L1  | 0.00        | 0.03 |
| L2  | 0.15 REF    |      |

GENERIC MARKING DIAGRAM\*

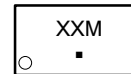

- XX = Specific Device Code
- M = Date Code
- = Pb-Free Package

\*This information is generic. Please refer to device data sheet for actual part marking. Pb-Free indicator, "G" or microdot "▪", may or may not be present.

MOUNTING FOOTPRINT  
SOLDERMASK DEFINED

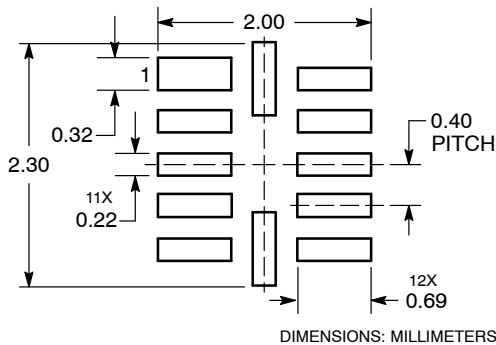

|                  |                        |  |
|------------------|------------------------|--|
| DOCUMENT NUMBER: | 98AON23418D            | Electronic versions are uncontrolled except when accessed directly from the Document Repository. Printed versions are uncontrolled except when stamped "CONTROLLED COPY" in red. |
| DESCRIPTION:     | UQFN12 1.7 X 2.0, 0.4P | PAGE 1 OF 1  |

ON Semiconductor and ON are trademarks of Semiconductor Components Industries, LLC dba ON Semiconductor or its subsidiaries in the United States and/or other countries. ON Semiconductor reserves the right to make changes without further notice to any products herein. ON Semiconductor makes no warranty, representation or guarantee regarding the suitability of its products for any particular purpose, nor does ON Semiconductor assume any liability arising out of the application or use of any product or circuit, and specifically disclaims any and all liability, including without limitation special, consequential or incidental damages. ON Semiconductor does not convey any license under its patent rights nor the rights of others.

**onsemi**, **Onsemi**, and other names, marks, and brands are registered and/or common law trademarks of Semiconductor Components Industries, LLC dba "**onsemi**" or its affiliates and/or subsidiaries in the United States and/or other countries. **onsemi** owns the rights to a number of patents, trademarks, copyrights, trade secrets, and other intellectual property. A listing of **onsemi**'s product/patent coverage may be accessed at [www.onsemi.com/site/pdf/Patent-Marking.pdf](http://www.onsemi.com/site/pdf/Patent-Marking.pdf). **onsemi** reserves the right to make changes at any time to any products or information herein, without notice. The information herein is provided "as-is" and **onsemi** makes no warranty, representation or guarantee regarding the accuracy of the information, product features, availability, functionality, or suitability of its products for any particular purpose, nor does **onsemi** assume any liability arising out of the application or use of any product or circuit, and specifically disclaims any and all liability, including without limitation special, consequential or incidental damages. Buyer is responsible for its products and applications using **onsemi** products, including compliance with all laws, regulations and safety requirements or standards, regardless of any support or applications information provided by **onsemi**. "Typical" parameters which may be provided in **onsemi** data sheets and/or specifications can and do vary in different applications and actual performance may vary over time. All operating parameters, including "Typicals" must be validated for each customer application by customer's technical experts. **onsemi** does not convey any license under any of its intellectual property rights nor the rights of others. **onsemi** products are not designed, intended, or authorized for use as a critical component in life support systems or any FDA Class 3 medical devices or medical devices with a same or similar classification in a foreign jurisdiction or any devices intended for implantation in the human body. Should Buyer purchase or use **onsemi** products for any such unintended or unauthorized application, Buyer shall indemnify and hold **onsemi** and its officers, employees, subsidiaries, affiliates, and distributors harmless against all claims, costs, damages, and expenses, and reasonable attorney fees arising out of, directly or indirectly, any claim of personal injury or death associated with such unintended or unauthorized use, even if such claim alleges that **onsemi** was negligent regarding the design or manufacture of the part. **onsemi** is an Equal Opportunity/Affirmative Action Employer. This literature is subject to all applicable copyright laws and is not for resale in any manner.

## PUBLICATION ORDERING INFORMATION

### LITERATURE FULFILLMENT:

Email Requests to: [orderlit@onsemi.com](mailto:orderlit@onsemi.com)

**onsemi** Website: [www.onsemi.com](http://www.onsemi.com)

### TECHNICAL SUPPORT

**North American Technical Support:**  
Voice Mail: 1 800-282-9855 Toll Free USA/Canada  
Phone: 011 421 33 790 2910

**Europe, Middle East and Africa Technical Support:**

Phone: 00421 33 790 2910

For additional information, please contact your local Sales Representative