



### ORDERING INFORMATION

Part Number*	Package	Top Marking
MP26124GR	QFN-16 (4mmx4mm)	See Below

\*For Tape & Reel, add suffix –Z (e.g. MP26124GR–Z)

### TOP MARKING

**MPSYWW**

**M26124**

**LLLLLL**

MP: MPS prefix  
 Y: Year code  
 WW: Week code  
 M26124: Product code of MP26124GR  
 LLLLLL: Lot number

### PACKAGE REFERENCE

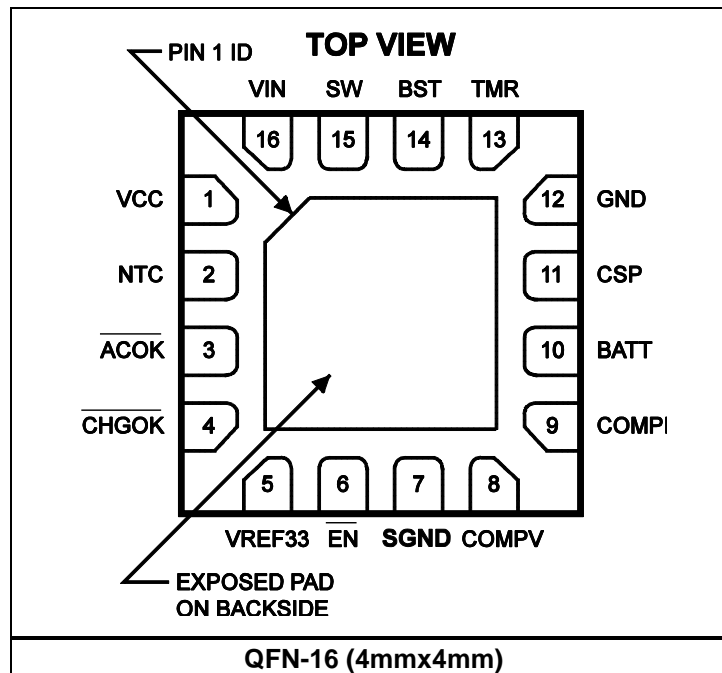

**ABSOLUTE MAXIMUM RATINGS <sup>(1)</sup>**

Supply voltage (VCC, VIN) .....	28V
V <sub>SW</sub> .....	-0.3V to (VIN + 0.3V)
V <sub>BST</sub> .....	V <sub>SW</sub> + 6V
V <sub>CSP</sub> , V <sub>BATT</sub> .....	-0.3V to +20V
V <sub>ACOK</sub> , V <sub>CHGOK</sub> .....	-0.3V to +28V
All other pins .....	-0.3V to +6V
Continuous power dissipation (T <sub>A</sub> = 25°C) <sup>(2)</sup>	
.....	2.7W
Junction temperature .....	150°C
Lead temperature .....	260°C
Storage temperature .....	-65°C to +150°C

**Recommended Operating Conditions <sup>(3)</sup>**

Supply voltage (VIN) .....	18V to 24V
Maximum junction temp. (T <sub>J</sub> ) .....	125°C

<b>Thermal Resistance <sup>(4)</sup></b>	<b>θ<sub>JA</sub></b>	<b>θ<sub>JC</sub></b>	
QFN-16 (4mmx4mm) .....	46.....	10 ...	°C/W

**NOTES:**

- 1) Exceeding these ratings may damage the device.
- 2) The maximum allowable power dissipation is a function of the maximum junction temperature T<sub>J</sub>(MAX), the junction-to-ambient thermal resistance θ<sub>JA</sub>, and the ambient temperature T<sub>A</sub>. The maximum allowable continuous power dissipation at any ambient temperature is calculated by P<sub>D</sub>(MAX)=(T<sub>J</sub>(MAX)-T<sub>A</sub>)/θ<sub>JA</sub>. Exceeding the maximum allowable power dissipation produces an excessive die temperature, causing the regulator to go into thermal shutdown. Internal thermal shutdown circuitry protects the device from permanent damage.
- 3) The device is not guaranteed to function outside of its operating conditions.
- 4) Measured on JESD51-7 4-layer board.

## ELECTRICAL CHARACTERISTICS

V<sub>IN</sub> = 24V, T<sub>A</sub> = 25°C, unless otherwise noted.

Parameters	Symbol	Condition	Min	Typ	Max	Units
Terminal battery voltage	V <sub>BATT</sub>		16.67	16.8	16.93	V
CSP, BATT current	I <sub>CSP</sub> , I <sub>BATT</sub>	Charging disabled		1		μA
Switch on resistance	R <sub>DS(ON)</sub>			200		mΩ
Switch leakage		$\overline{EN} = 4V, V_{SW} = 0V$		0	1	μA
Peak current limit	CC <sup>(5)</sup>			4.1		A
	TRICKLE			2		A
CC current	I <sub>CC</sub>	RS1 = 100mΩ	1900	2100	2300	mA
Trickle charge current	I <sub>TRICKLE</sub>			10%		I <sub>CC</sub>
Trickle charge voltage threshold	V <sub>TC</sub>			12.0		V
Trickle charge hysteresis				1400		mV
Termination current threshold	I <sub>BF</sub>		5%	10%	15%	I <sub>CC</sub>
Oscillator frequency	f <sub>SW</sub>	V <sub>BATT</sub> = 14V		600		kHz
Fold-back frequency		V <sub>BATT</sub> = 0V		190		kHz
Maximum duty cycle			90			%
Maximum current sense voltage (CSP to BATT)	V <sub>SENSE</sub>		180	210	240	mV
Minimum on time <sup>(5)</sup>	t <sub>ON</sub>			100		ns
Under-voltage lockout threshold rising			3.05	3.25	3.45	V
Under-voltage lockout threshold hysteresis				300		mV
Open-drain sink current		V <sub>DRAIN</sub> = 0.3V	5			mA
Dead battery indicator		In trickle mode, C <sub>TMR</sub> = 0.1μF		30		min
Recharge threshold at V <sub>BATT</sub>	V <sub>RECHG</sub>			16.0		V
Recharge hysteresis				400		mV
NTC low-temp rising threshold	V <sub>TL</sub>	As a percentage of VREF33	64.2	65.2	66.2	%
NTC high-temp falling threshold	V <sub>TH</sub>	As a percentage of VREF33	34	35	36	%
V <sub>IN</sub> min head room (reverse blocking)		V <sub>IN</sub> - V <sub>BATT</sub>		250		mV

**ELECTRICAL CHARACTERISTICS (continued)**
**V<sub>IN</sub> = 24V, T<sub>A</sub> = 25°C, unless otherwise noted.**

Parameters	Symbol	Condition	Min	Typ	Max	Units
$\overline{\text{EN}}$ input low voltage					0.4	V
$\overline{\text{EN}}$ input high voltage			1.8			V
$\overline{\text{EN}}$ input current		$\overline{\text{EN}} = 4\text{V}$		4		$\mu\text{A}$
		$\overline{\text{EN}} = 0\text{V}$		0.2		
Supply current (shutdown)		$\overline{\text{EN}} = 4\text{V}$		0.5		mA
		$\overline{\text{EN}} = 4\text{V}$ , considering the VREF33 output current, R <sub>3</sub> = 10k $\Omega$ , R <sub>NTC</sub> = 10k $\Omega$		0.665		mA
Supply current (quiescent)		$\overline{\text{EN}} = 0\text{V}$			2.0	mA
Thermal shutdown <sup>(5)</sup>				150		°C
VREF33 output voltage				3.3		V
VREF33 load regulation		I <sub>LOAD</sub> = 0 to 10mA		35		mV

**NOTE:**

5) Guaranteed by design.

## TYPICAL PERFORMANCE CHARACTERISTICS

VIN = 18V, C1 = 4.7μF, C2 = 22μF, L = 10μH, RS1 = 200mΩ, real/simulation battery load, TA = 25°C, unless otherwise noted.

### 4-Cell Charge Current vs. Battery Voltage

Battery simulator

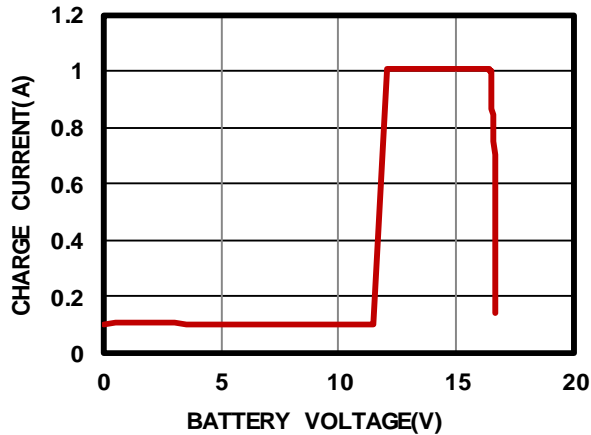

### Efficiency vs. ICHG

4 cells, VBATT = 16.4V

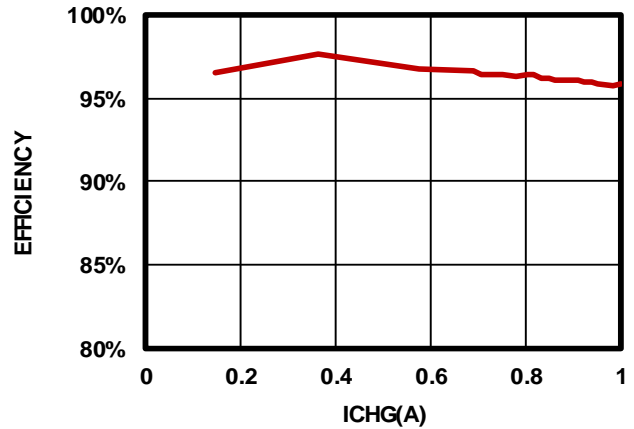

### Efficiency vs. VIN

4 cells, VBATT = 14.8V

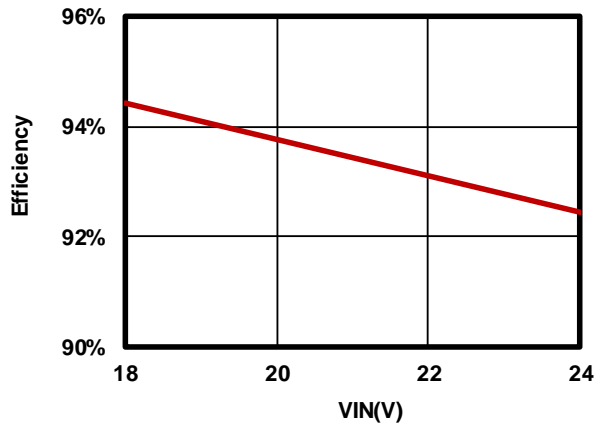

### NTC Control Window

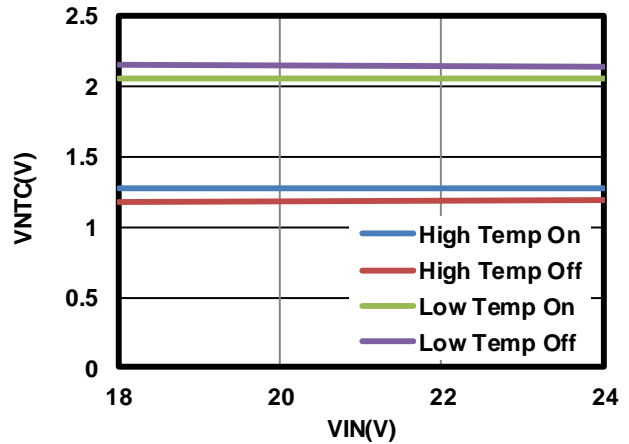

### Battery Leakage Current vs. VBATT

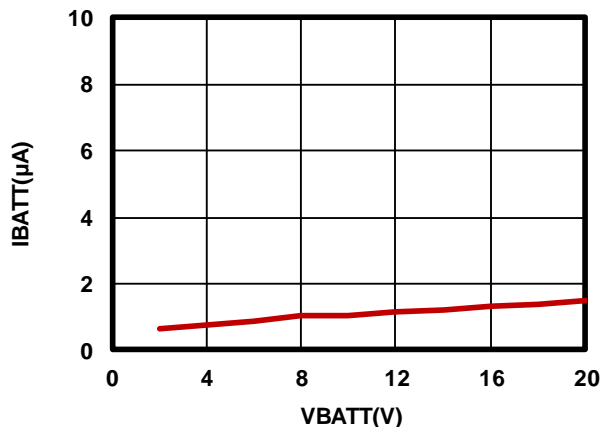

### BATT Full Voltage vs. VIN

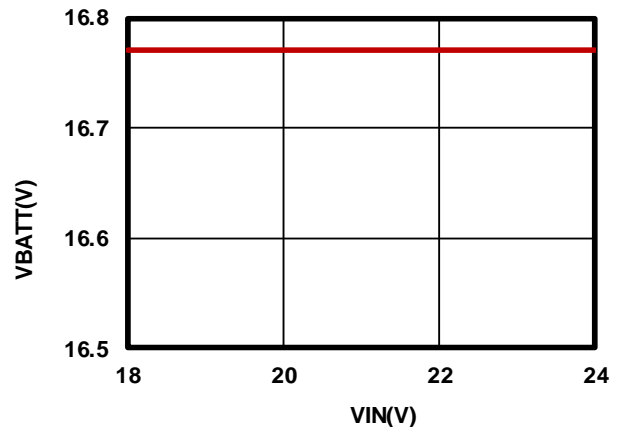

**TYPICAL PERFORMANCE CHARACTERISTICS (continued)**

VIN = 18V, C1 = 4.7 $\mu$ F, C2 = 22 $\mu$ F, L = 10 $\mu$ H, RS1 = 200m $\Omega$ , real/simulation battery load, TA = 25°C, unless otherwise noted.

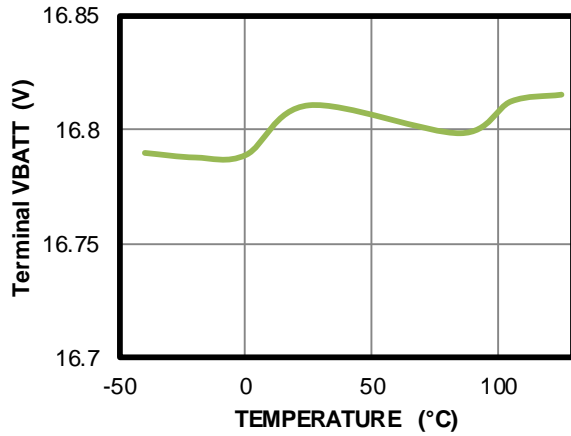
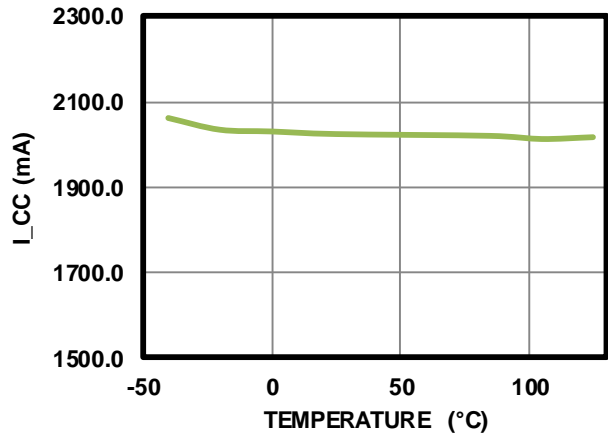
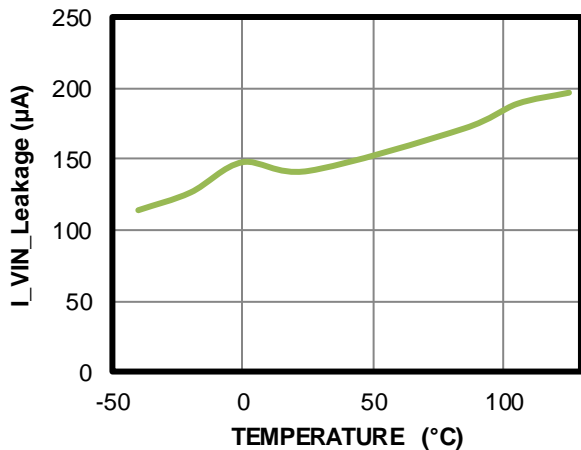
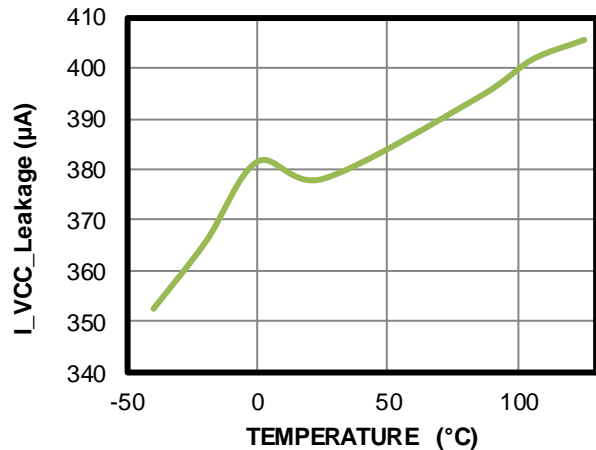
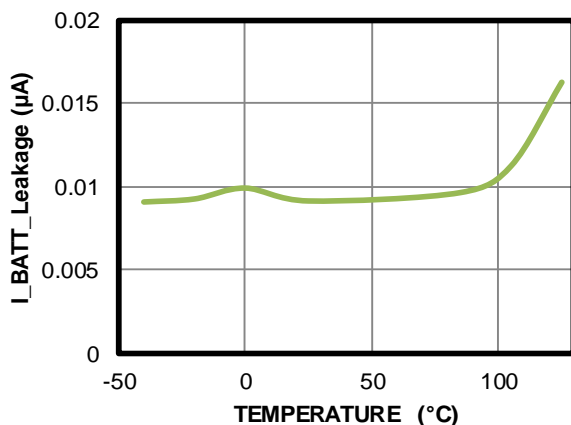
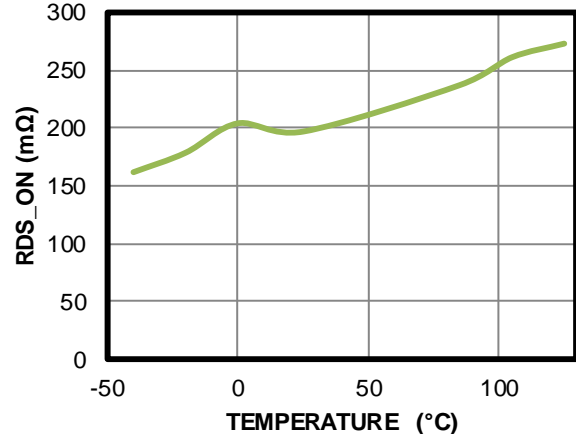
**Terminal Battery Voltage vs. Temperature**

**Charge Current vs. Temperature**  
 RS1 = 100m $\Omega$ , BATT = 14V

**VIN Leakage Current @ 28V vs. Temperature**

**VCC Leakage Current @ 28V vs. Temperature**  
 BATT = 20V

**I<sub>BATT</sub> Leakage @ 20V vs. Temperature**

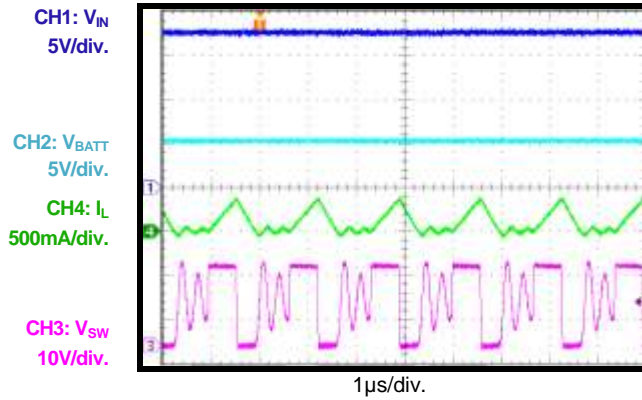
**R<sub>DS(ON)</sub> vs. Temperature**

**TYPICAL PERFORMANCE CHARACTERISTICS (continued)**

$V_{IN} = 18V$ ,  $C1 = 4.7\mu F$ ,  $C2 = 22\mu F$ ,  $L = 10\mu H$ ,  $RS1 = 200m\Omega$ , real/simulation battery load,  $T_A = 25^\circ C$ , unless otherwise noted.

**Steady State**

Trickle charge, 4 cells,  $V_{BATT} = 10V$

**Steady State**

CC charge, 4 cells,  $V_{BATT} = 14.4V$

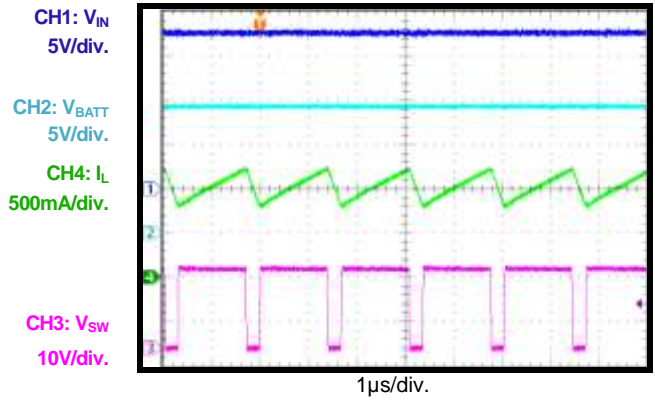
**Steady State**

CV charge, 4 cells,  $V_{BATT} = 16.6V$

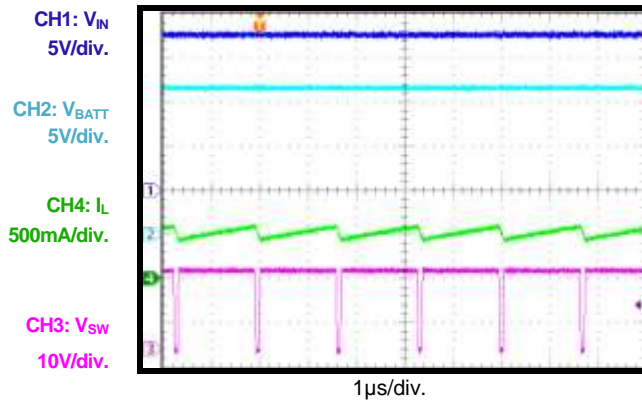
**Power On**

4 cells,  $I_{CHG} = 1A$ ,  $V_{BATT} = 13.2V$

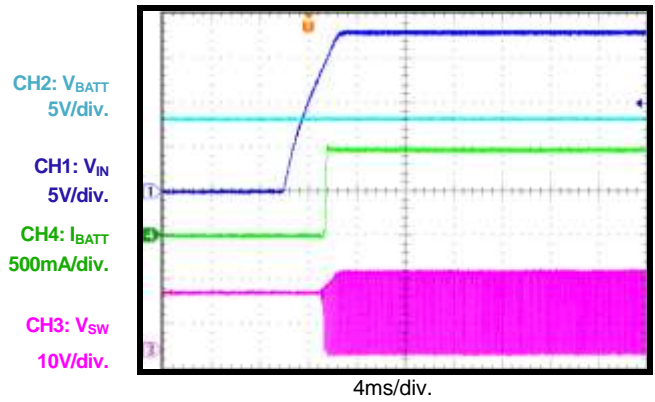
**Power Off**

4 cells,  $I_{CHG} = 1A$ ,  $V_{BATT} = 13.2V$

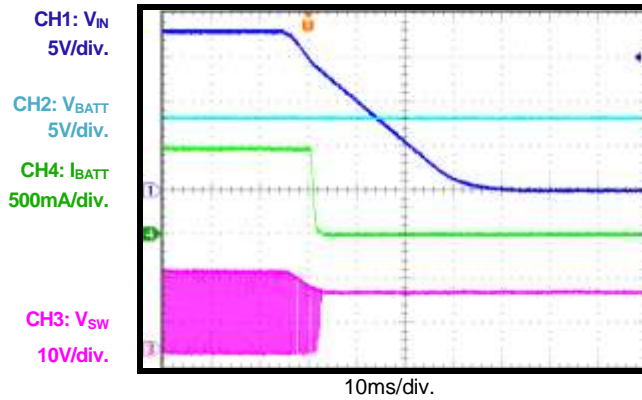
**EN On**

4 cells,  $I_{CHG} = 1A$ ,  $V_{BATT} = 13.2V$

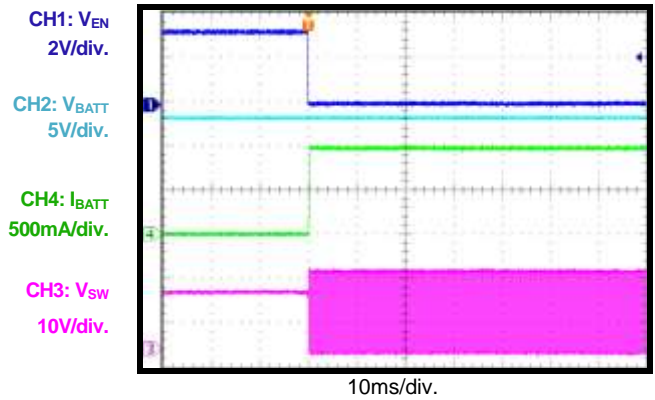



**TYPICAL PERFORMANCE CHARACTERISTICS (continued)**

$V_{IN} = 18V$ ,  $C1 = 4.7\mu F$ ,  $C2 = 22\mu F$ ,  $L = 10\mu H$ ,  $RS1 = 200m\Omega$ , real/simulation battery load,  $T_A = 25^\circ C$ , unless otherwise noted.

**EN Off**

4 cells,  $I_{CHG} = 1A$ ,  $V_{BATT} = 13.2V$

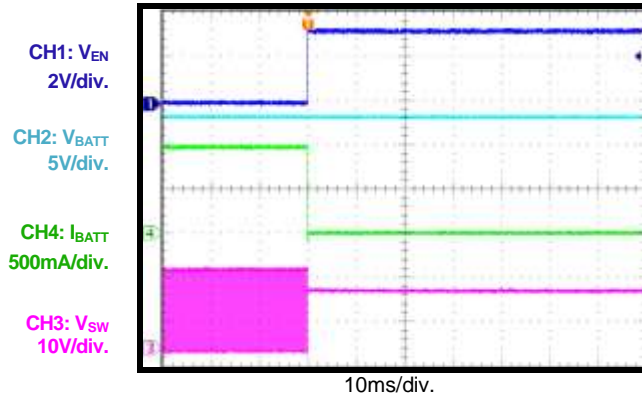
**NTC Control**

4 cells,  $I_{CHG} = 1A$ ,  $V_{BATT} = 13.2V$

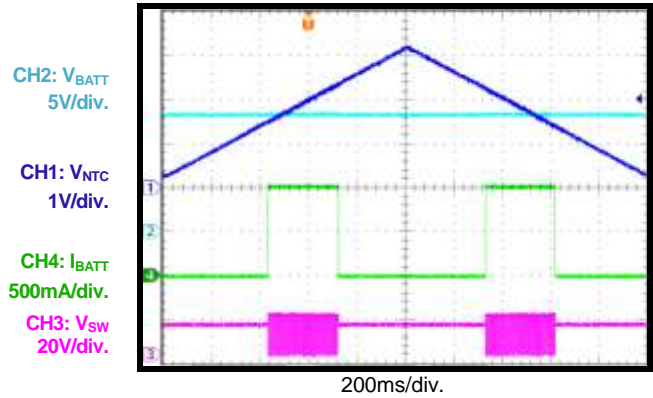

**Timer Out**

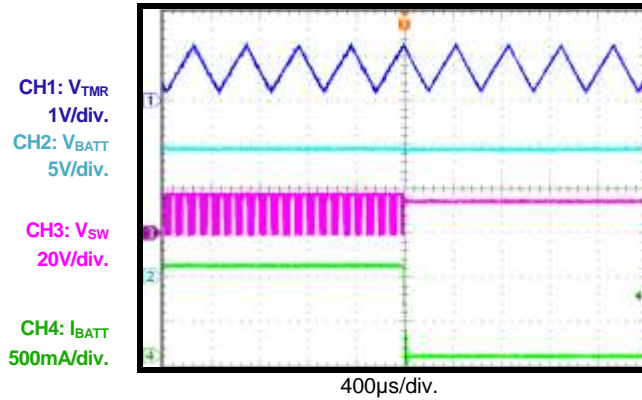
4 cells,  $I_{CHG} = 1A$ ,  $V_{BATT} = 13.2V$

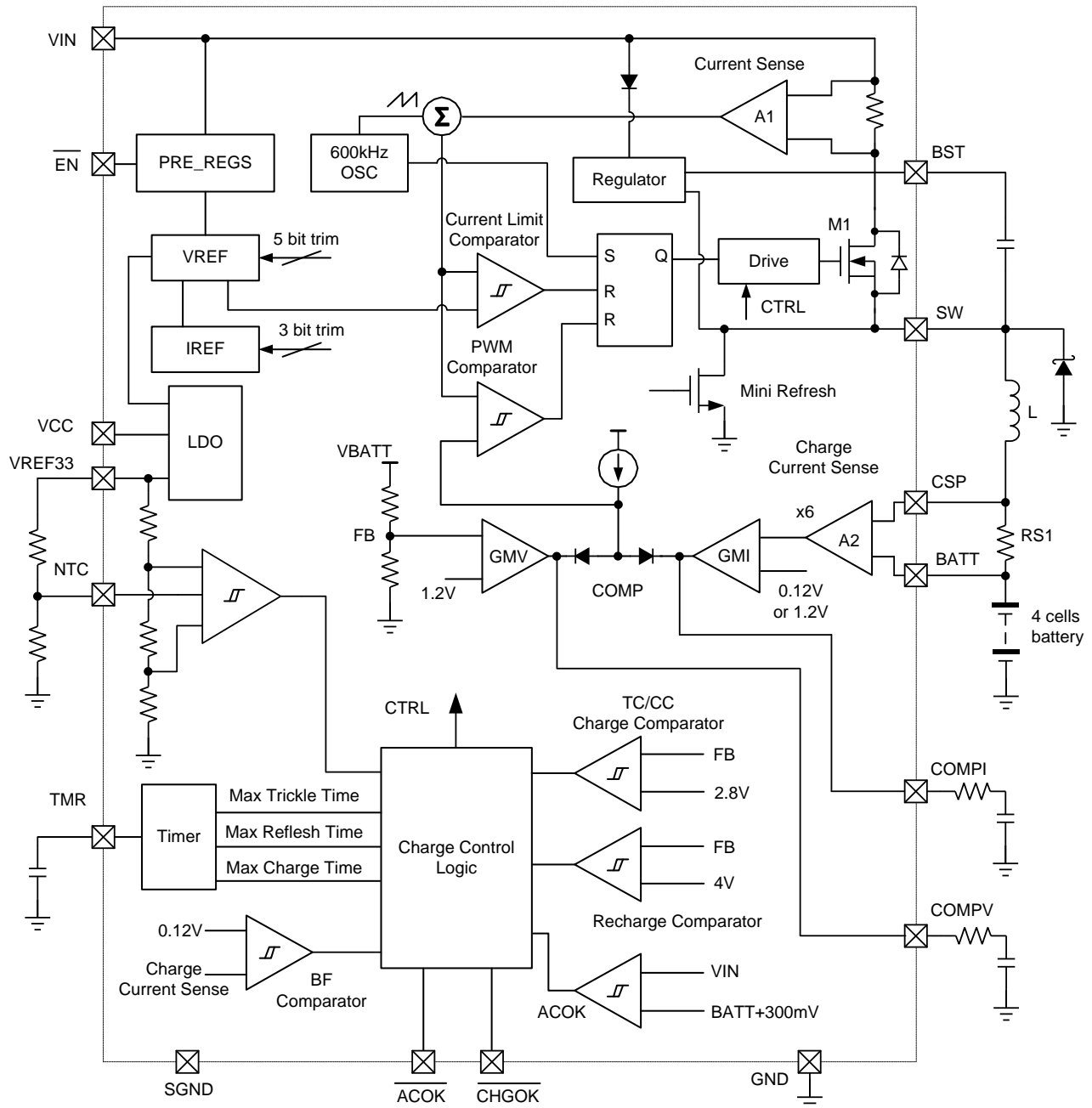

## PIN FUNCTIONS

Pin #	Name	Description
1	VCC	<b>IC supply voltage.</b>
2	NTC	<b>Thermistor input.</b> Connect a resistor from NTC to VREF33. Connect the thermistor from NTC to ground.
3	$\overline{\text{ACOK}}$	<b>Valid input supply indicator.</b> $\overline{\text{ACOK}}$ is an open-drain output. Add a pull-up resistor to $\overline{\text{ACOK}}$ . Logic low indicates the presence of a valid input supply.
4	$\overline{\text{CHGOK}}$	<b>Charging status indicator.</b> $\overline{\text{CHGOK}}$ is an open-drain output. Add a pull-up resistor to $\overline{\text{CHGOK}}$ . Logic low indicates normal charging. Logic high indicates either a completed charge process or suspended process due to a fault.
5	VREF33	<b>Internal linear regulator, 3.3V reference output.</b> Bypass VREF33 to GND with a 1 $\mu$ F ceramic capacitor.
6	$\overline{\text{EN}}$	<b>On/off control input.</b>
7	SGND	<b>Definition.</b> Connect SGND to the GND plane.
8	COMPV	<b>V-LOOP compensation.</b> Decouple COMPV with a capacitor and a resistor.
9	COMPI	<b>I-LOOP compensation.</b> Decouple COMPI with a capacitor and a resistor.
10	BATT	<b>Positive battery terminal.</b>
11	CSP	<b>Battery charge current sense positive input.</b> Connect a resistor (RS1) between CSP and BATT. The full charge current is: $I_{\text{CHG}}(\text{A}) = \frac{200\text{mV}}{\text{RS1}(\text{m}\Omega)}$ .
12	GND	<b>Ground.</b> GND is the voltage reference for the regulated output voltage. This node should be placed outside of the switching diode (D2) to the input ground path to prevent switching current spikes from inducing voltage noise into the part.
13	TMR	<b>Safe timer period.</b> A 0.1 $\mu$ A current charges and discharges the external capacitor decoupled to GND. The capacitor value programs the timer period.
14	BST	<b>Bootstrap.</b> A charged capacitor is required to drive the power switch's gate above the supply voltage. Connect a capacitor between SW and BST to form a floating supply across the power switch driver.
15	SW	<b>Switch output.</b>
16	VIN	<b>Input voltage.</b> The MP26124 regulates an up to 24V input to a voltage suitable for charging a 4-series Li-ion battery pack. Capacitors are required to prevent large voltage spikes from appearing at the input.

**BLOCK DIAGRAM**

**Figure 1: Functional Block Diagram**

## OPERATION

The MP26124 is a peak-current mode-controlled switching charger for use with Li-ion batteries.

At the beginning of a cycle, the MOSFET (M1) is off, and the COMP voltage is higher than the output of the current sense amplifier (A1). The pulse-width modulation (PWM) comparator's output is low, and the rising edge of the 600kHz CLK signal sets the RS flip-flop, which turns on M1, connecting SW and the inductor to the input supply.

As the inductor current increases, the output of A1 increases. When this signal exceeds the COMP voltage, the RS flip-flop resets and turns M1 off. The external switching diode (D2) then conducts the inductor current.

The MP26124 uses COMP to select the smaller value of GMI and GMV to implement either current loop control or voltage loop control. Current loop control occurs when the battery voltage is low, which results in the saturation of the GMV output. GMI compares the charge current (as a voltage sensed through RS1) against the reference voltage to regulate the charge current to a constant value. When the battery voltage charges up to the reference voltage, the output of GMV goes low and initiates voltage loop control to control the duty cycle to regulate the output voltage.

The MP26124 has an internal linear regulator (VREF33) to power the internal circuitry. VREF33 can also power external circuitry as long as the load does not exceed the maximum current (30mA). Connect a 1 $\mu$ F bypass capacitor from VREF33 to GND to ensure stability.

### Charge Cycle (Mode Change: Trickle $\rightarrow$ CC $\rightarrow$ CV)

At the start of a charging cycle, the MP26124 monitors  $V_{BATT}$ . If  $V_{BATT}$  is lower than the trickle-charge threshold ( $V_{TC}$ , typically 3.0V/cell), the charging cycle starts in trickle-charge mode (10% of the RS1 programmed constant-charge current,  $I_{CC}$ ) until the battery voltage reaches  $V_{TC}$ .

If the charge stays in trickle-charging mode until the time-out condition is triggered, charging terminates until the input power or  $\overline{EN}$  signal refreshes. Otherwise, GMI regulates the charge current to the level set by RS1. The charger operates at constant-current (CC) charging mode. The duty cycle of the switcher is determined by the COMPI voltage, which is regulated by the amplifier GMI.

When the battery voltage reaches the constant-voltage mode threshold, GMV regulates COMP and the duty cycle for constant voltage (CV) mode. When the charge current drops to the battery-full threshold ( $I_{BF}$ , typical 10% CC), the battery is defined as fully charged. The charger stops charging, and CHGOK goes high to indicate the charge-full condition. If the total charge time exceeds the timer period, the charging terminates immediately and resumes when either the input power or EN signal can restart the charger.

Figure 2 shows the typical charge profile of the MP26124.

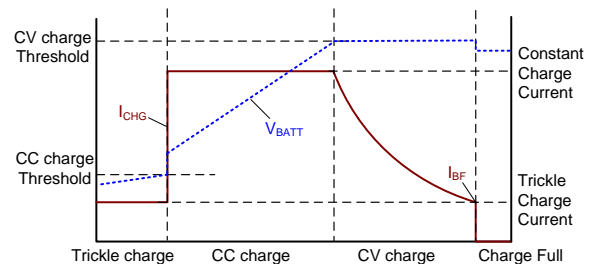

Figure 2: Li-Ion Battery Charge Profile

### Automatic Recharge

After the battery has completely recharged, the charger disables all blocks except for the battery voltage monitor to limit the leakage current. If the battery voltage falls below 4.0V/cell, the MP26124 begins recharging with a soft start. The timer then resets to avoid timer-related charging disruptions.

### Charger Status Indication

The MP26124 has two open-drain status outputs:  $\overline{ACOK}$  and  $\overline{CHGOK}$ .  $\overline{ACOK}$  goes low when the IC supply voltage ( $V_{CC}$ ) exceeds the under-voltage lockout (UVLO) threshold and the regulated voltage ( $V_{IN}$ ) is 300mV higher than  $V_{BATT}$  to ensure that the regulator can operate

normally.  $\overline{\text{CHGOK}}$  indicates the charge status. Table 1 describes the  $\overline{\text{ACOK}}$  and  $\overline{\text{CHGOK}}$  outputs under different charge conditions.

**Table 1: Charging Status Indication**

$\overline{\text{ACOK}}$	$\overline{\text{CHGOK}}$	Charger Status
low	low	In charging
low	high	End of charge, NTC fault, timer out, thermal shutdown, $\overline{\text{EN}}$ disable
high	high	$V_{\text{IN}} - V_{\text{BATT}} < 0.3\text{V}$ $V_{\text{CC}} < \text{UVLO}$

### Timer Operation

The MP26124 uses the internal timer to limit the charge period during trickle charge and total charge cycle. Once the charge time exceeds the time limit, the MP26124 terminates charging. A good battery should recharge completely within the allotted time period. Otherwise, the battery has a fault. An external capacitor at TMR programs the time period.

The trickle mode charge time can be calculated with Equation (1):

$$T_{\text{TRICKLE\_TMR}} = 30\text{mins} \times \frac{C_{\text{TMR}}}{0.1\mu\text{F}} \quad (1)$$

The total charge time can be calculated with Equation (2):

$$T_{\text{TOTAL\_TMR}} = 3\text{hours} \times \frac{C_{\text{TMR}}}{0.1\mu\text{F}} \quad (2)$$

When time-out occurs, charging is suspended. The charge cycle can be restarted by refreshing the input power or EN signal or auto-recharge ( $V_{\text{BATT}}$  falls through 4V/cell).

### Negative Thermal Coefficient (NTC) Thermistor

The MP26124 has a built-in NTC resistance window comparator that allows the MP26124 to sense the battery temperature through the thermistor included in the battery pack. Connect a resistor with an appropriate value from VREF33 to NTC, and connect the thermistor from NTC to GND. A resistor divider determines the voltage on NTC as a function of the battery temperature. Charging stops when the NTC voltage exits the NTC window range. Charging resumes when the voltage is within the NTC window range.

# OPERATION FLOW CHART

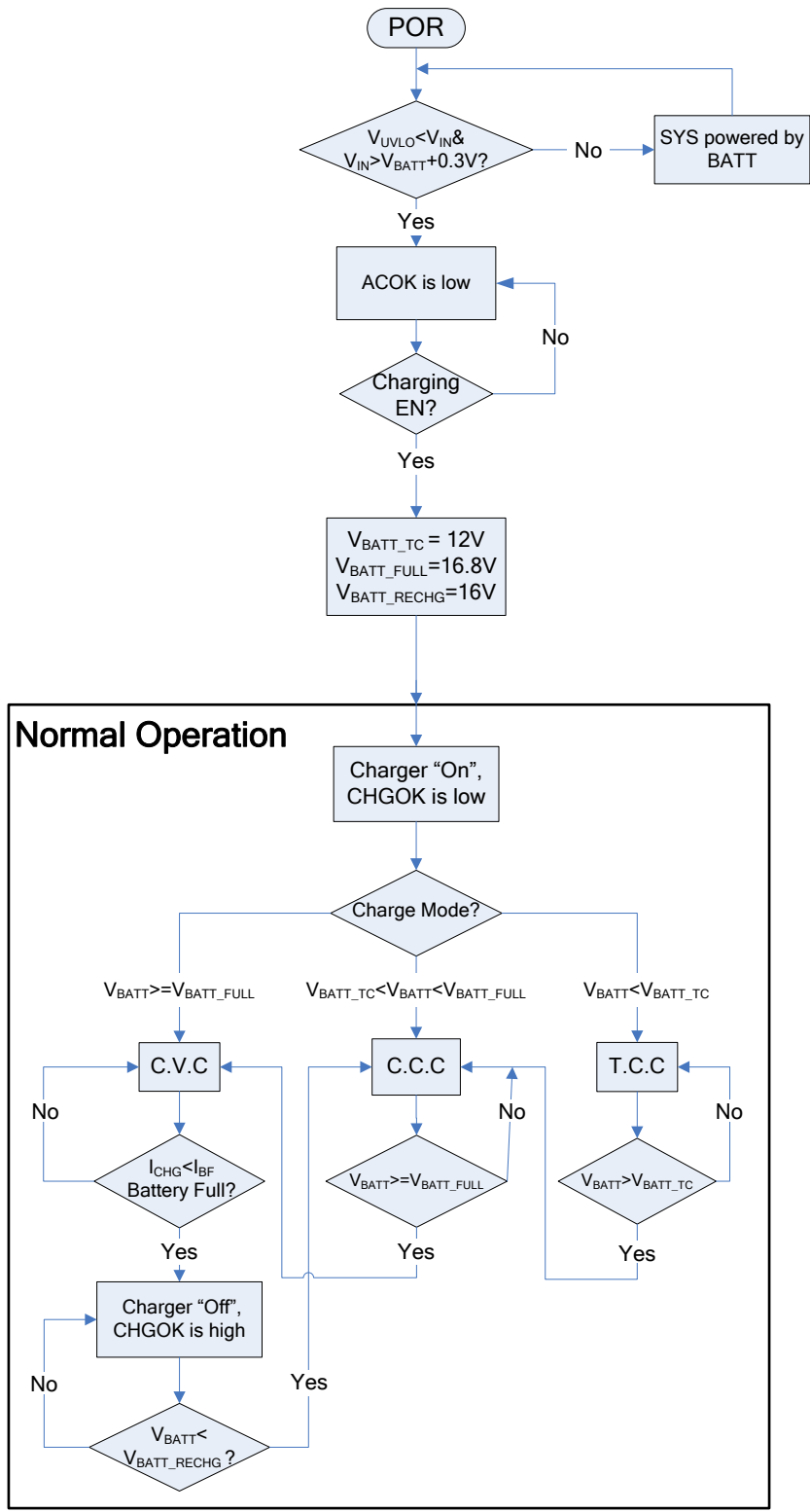

Figure 3: Normal Charging Operation Flow Chart

## OPERATION FLOW CHART (continued)

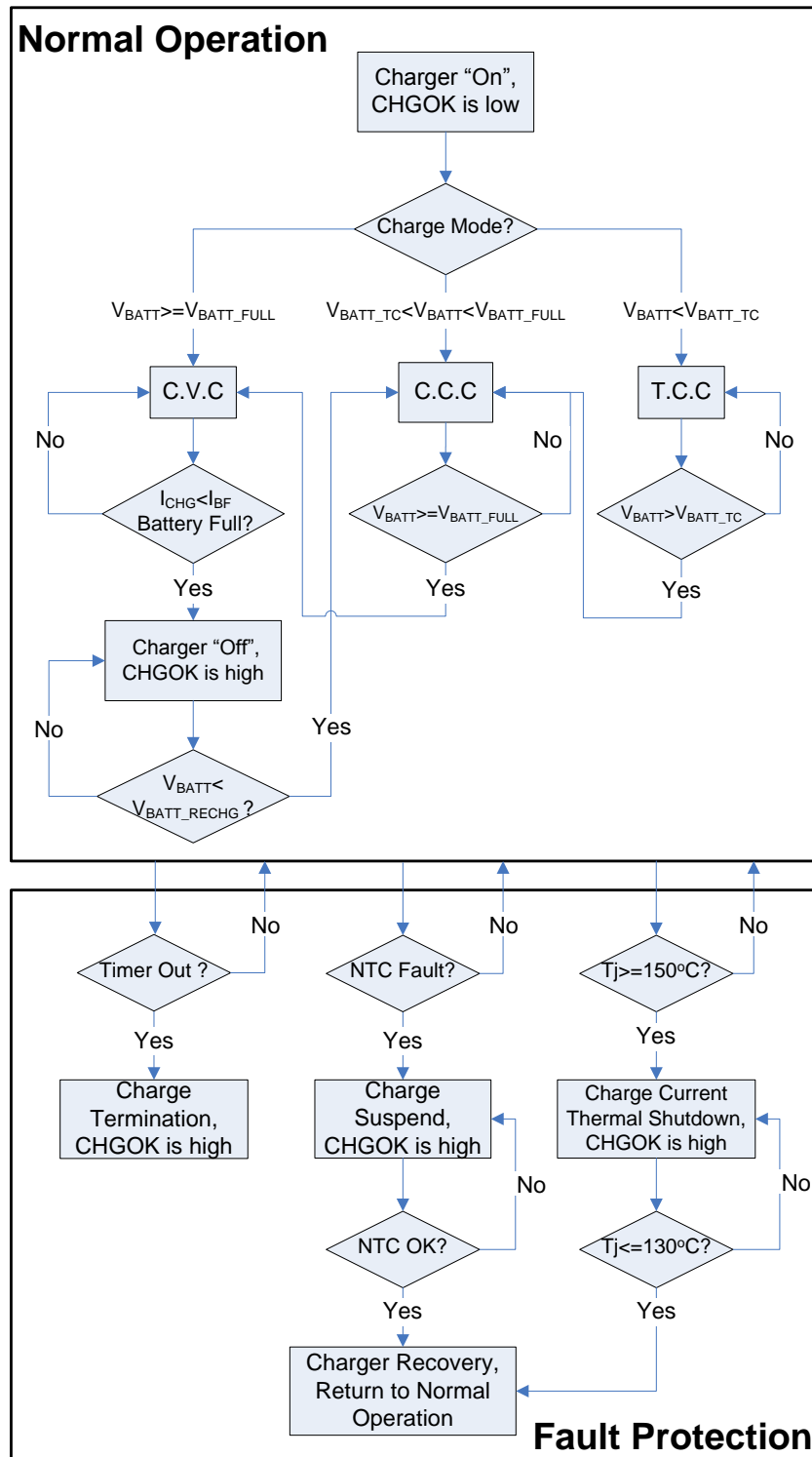

Figure 4: Fault Protection Flow Chart

## APPLICATION INFORMATION

### Setting the Charge Current

The charge current of the MP26124 is set by the sense resistor (RS1) and determined with Equation (3):

$$I_{CHG}(A) = \frac{200mV}{RS1(m\Omega)} \quad (3)$$

### Selecting the Inductor

Use a 10 $\mu$ H inductor for most applications. The inductance value can be derived from Equation (4):

$$L = \frac{V_{OUT} \times (V_{IN} - V_{OUT})}{V_{IN} \times \Delta I_L \times f_{OSC}} \quad (4)$$

Where  $\Delta I_L$  is the inductor ripple current, and  $V_{OUT}$  is the 4-series battery voltage. Choose  $\Delta I_L$  to be approximately 30% of the maximum charge current (2A).

The maximum inductor peak current can be calculated with Equation (5):

$$I_{L(MAX)} = I_{CHG} + \frac{\Delta I_L}{2} \quad (5)$$

Select an inductor with a proper DC resistance to balance efficiency/thermal and cost.

### NTC Function

The low temperature threshold and high-temperature threshold are preset internally to  $V_{TL} \cdot VREF33$  and  $V_{TH} \cdot VREF33$  using a resistor divider (see Figure 5). For a given NTC thermistor, select an appropriate R3 and R6 value to set the NTC window with Equation (6) and Equation (7):

$$\frac{R6 // R_{NTC\_Cold}}{R3 + R6 // R_{NTC\_Cold}} = V_{TL} \quad (6)$$

$$\frac{R6 // R_{NTC\_Hot}}{R3 + R6 // R_{NTC\_Hot}} = V_{TH} \quad (7)$$

Where  $R_{NTC\_Hot}$  is the value of the NTC resistor at the upper bound of its operating temperature range, and  $R_{NTC\_Cold}$  is the lower bound.

For example, assuming that the NTC window is between 0°C and 50°C, use the thermistor (NCP18XH103),  $R_{NTC\_Cold} = 27.445k\Omega$  at 0°C, and  $R_{NTC\_Hot} = 4.1601k\Omega$  at 50°C.

According to Equation (6) and Equation (7),  $R3 = 6.49k\Omega$  and  $R6 = 21.83k\Omega$ .

For no NTC application, select  $R3 = R6 = 10k\Omega$ .

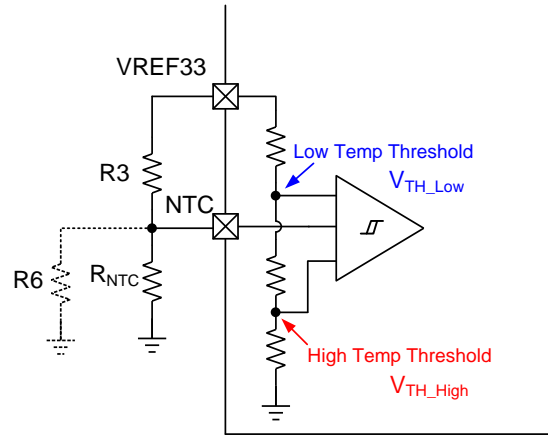

**Figure 5: NTC Function Block**

### Selecting the Input Capacitor

The input capacitor reduces the surge current drawn from the input and the switching noise from the device. Choose an input capacitor with an impedance at the switching frequency less than the input source impedance to prevent high-frequency switching current. Use ceramic capacitors with X5R or X7R dielectrics with low ESR and small temperature coefficients. A 4.7 $\mu$ F capacitor is sufficient for most applications.

### Selecting the Output Capacitor

The output capacitor limits output voltage ripple and ensures regulation loop stability. The output capacitor impedance should be low at the switching frequency. Use ceramic capacitors with X5R or X7R dielectrics.

### Input Surge Protection

In the case that a long input adaptor wire is plugged into the board, the input wire parasitic inductance may oscillate with the input capacitance and induce a high voltage on VCC and VIN, which may damage the IC. It is recommended that a soft plug-in circuit is used for safe operation (see Figure 6 and Figure 7).

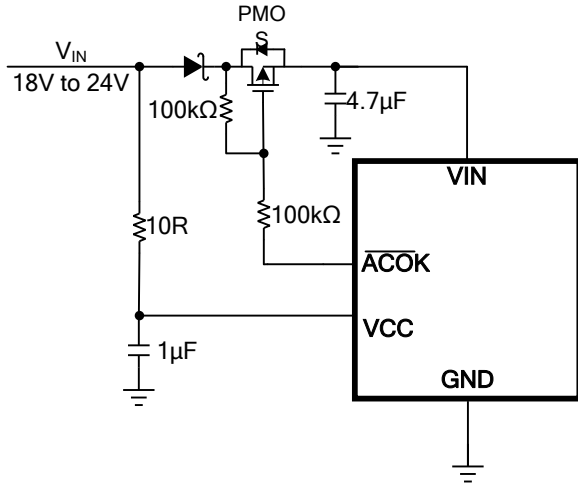
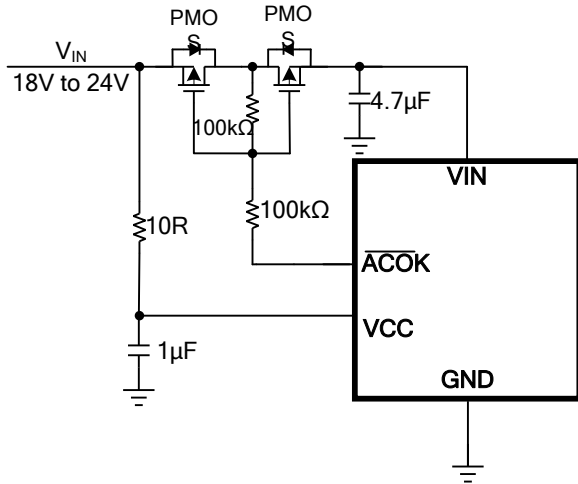

**Figure 6: Input Surge Protection with Diode**

**Figure 7: Input Surge Protection with P-MOSFET**

### PCB Layout Guidelines

Efficient PCB layout is critical for stable operation. For best results, follow the guidelines below.

1. Connect the high-frequency and high-current paths to the device with short, wide, and direct traces.
2. Minimize the loop of the input capacitor, IC VIN to SW, and the Schottky diode (which forms the high-frequency current circulation).
3. Place the external feedback resistors next to FB.
4. Keep the switching node SW short and away from the feedback network.

# PACKAGE INFORMATION

## QFN-16 (4mmx4mm)

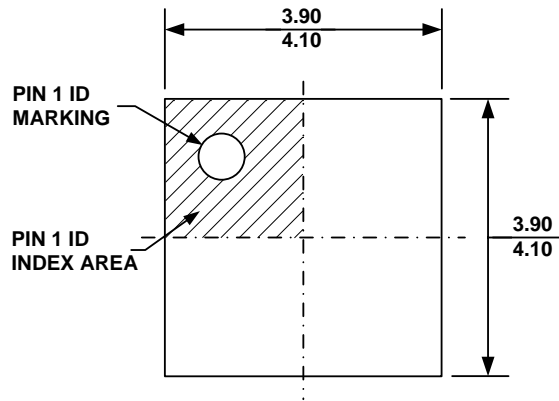

**TOP VIEW**

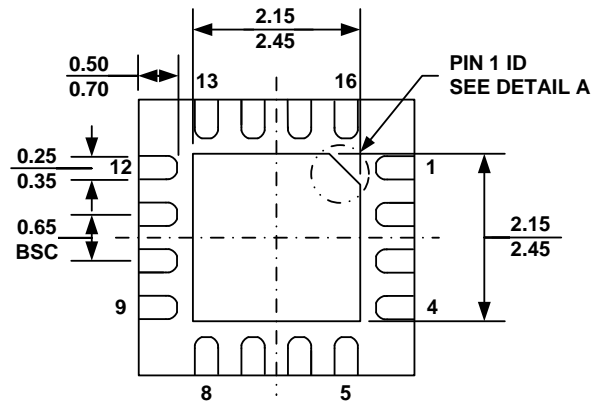

**BOTTOM VIEW**

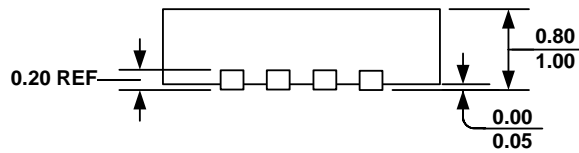

**SIDE VIEW**

**PIN 1 ID OPTION A**  
0.45x45° TYP.



**PIN 1 ID OPTION B**  
R0.25 TYP.

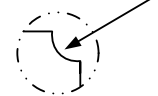

**DETAIL A**

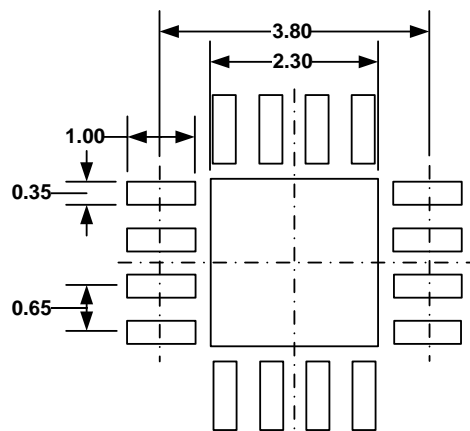

**RECOMMENDED LAND PATTERN**

**NOTE:**

- 1) ALL DIMENSIONS ARE IN MILLIMETERS.
- 2) EXPOSED PADDLE SIZE DOES NOT INCLUDE MOLD FLASH.
- 3) LEAD COPLANARITY SHALL BE 0.10 MILLIMETER MAX.
- 4) JEDEC REFERENCE IS MO-220, VARIATION VGGC.
- 5) DRAWING IS NOT TO SCALE.

**NOTICE:** The information in this document is subject to change without notice. Please contact MPS for current specifications. Users should warrant and guarantee that third party Intellectual Property rights are not infringed upon when integrating MPS products into any application. MPS will not assume any legal responsibility for any said applications.