

Product Document



Datasheet

DS000603

CMV12000

**12Mp High Speed Machine Vision Global Shutter
CMOS Image Sensor**

v5-00 • 2022-Feb-04

Content Guide

1	General Description	3	8	Register Description.....	71
1.1	Key Benefits & Features.....	3	8.1	Register Categories.....	71
1.2	Applications	3	8.2	Register Overview	71
1.3	Block Diagram	4	9	Application Information.....	76
2	Ordering Information	5	9.1	Color Filter	76
3	Pin Assignment	6	9.2	Socket.....	77
3.1	Pin Diagram.....	6	9.3	Pin Layout.....	77
3.2	Pin Description	6	10	Package Drawings & Markings... 78	
4	Absolute Maximum Ratings	13	11	Packing Information	80
5	Electrical Characteristics.....	14	12	Soldering & Storage Information 81	
6	Typical Operating Characteristics	16	12.1	Soldering.....	81
6.1	Electro-Optical Characteristics	16	12.2	Storage	82
6.2	Spectral Characteristics	17	13	Revision Information	83
7	Functional Description.....	19	14	Legal Information.....	84
7.1	Sensor Architecture	19			
7.2	Operating the Sensor	20			
7.3	Sensor Readout Format	28			
7.4	Configuring Exposure and Readout	36			
7.5	Configuring Output Data Format	57			
7.6	Additional Features	60			
7.7	Additional Required Register Settings	64			

1 General Description

The CMV12000 is a high speed CMOS image sensor with 4096 by 3072 pixels (22.5 mm x 16.9 mm) developed for machine vision and other applications. The image array consists of 5.5 μm x 5.5 μm pipelined global shutter pixels, which allow exposure during read-out. The image sensor has 64 8-, 10- or 12-bit digital LVDS outputs (serial). The image sensor also integrates a programmable gain amplifier and offset regulation. Each channel runs at 600 Mbit/s which results in 132 fps frame rate at full resolution and 12-bit. When 10-bit per pixel is used, the frame rate increases to 300 fps. Higher frame rates can be achieved in row-windowing mode or row-subsampling mode. These modes are all programmable using the SPI interface. A programmable on-board sequencer generates all internal exposure and read-out timings. External triggering and exposure programming is possible. Extended optical dynamic range can be achieved by multiple integrated high dynamic range modes.

1.1 Key Benefits & Features

The benefits and features of CMV12000, 12Mp High Speed Machine Vision Global Shutter CMOS Image Sensor are listed below:

Figure 1:
Added Value of Using CMV12000

Benefits	Features
Designed for high performance applications	A resolution of 4096x3072 at 300 frames per second
Capture fast moving objects	8T global shutter pixel with true Correlated Double Sampling (true CDS)
Select high frame rate or improved image quality	8-bit, 10-bit and 12-bit ADC
See bright and dark objects simultaneous	Standard dynamic range of 60 dB High Dynamic Range (HDR) modes possible

1.2 Applications

- Machine Vision
- High End Inspection
- Video/Broadcast
- Motion Capture
- Intelligent Transportation System (ITS)

1.3 Block Diagram

The functional blocks of this device are shown below:

Figure 2:
Functional Blocks of CMV12000

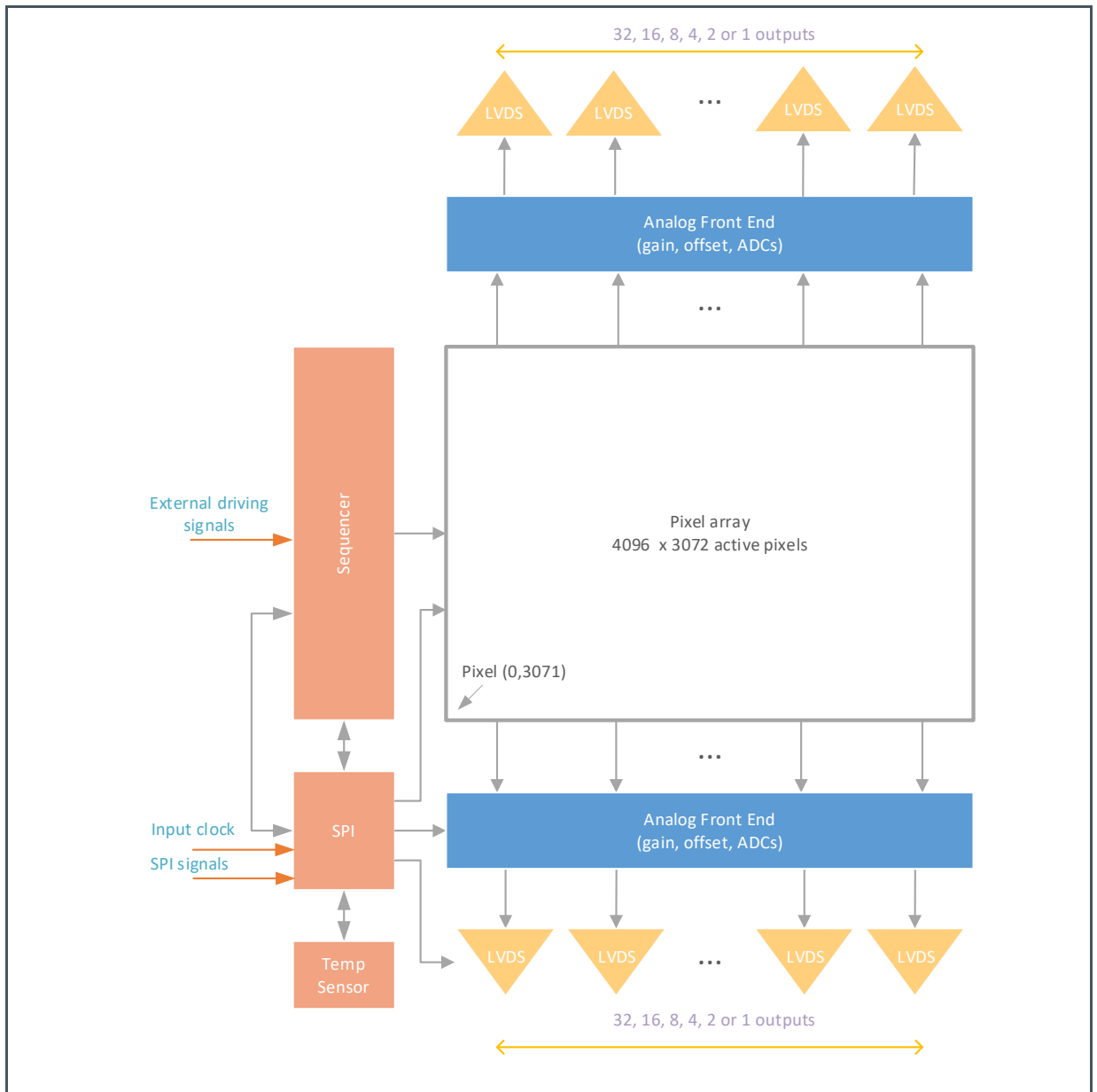

2 Ordering Information

Ordering Code	Package	Chroma	Delivery Quantity
CMV12000-2E5M1PA	237- μ PGA	Mono	18 pcs/tray
CMV12000-2E5C1PA	237- μ PGA	Color	18 pcs/tray
CMV12000-2E5M1PN	237- μ PGA	Mono	18 pcs/tray

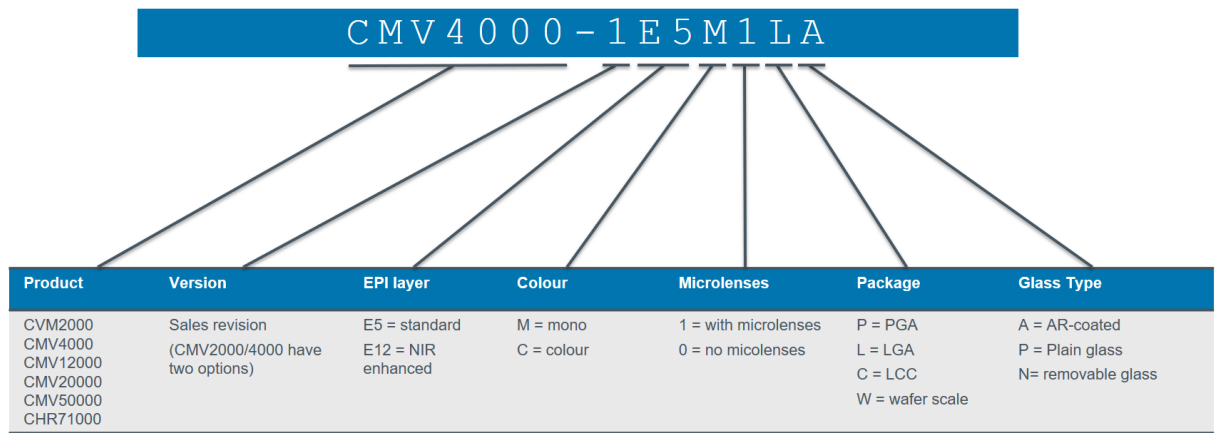

3 Pin Assignment

3.1 Pin Diagram

Figure 3:
Pin Numbering

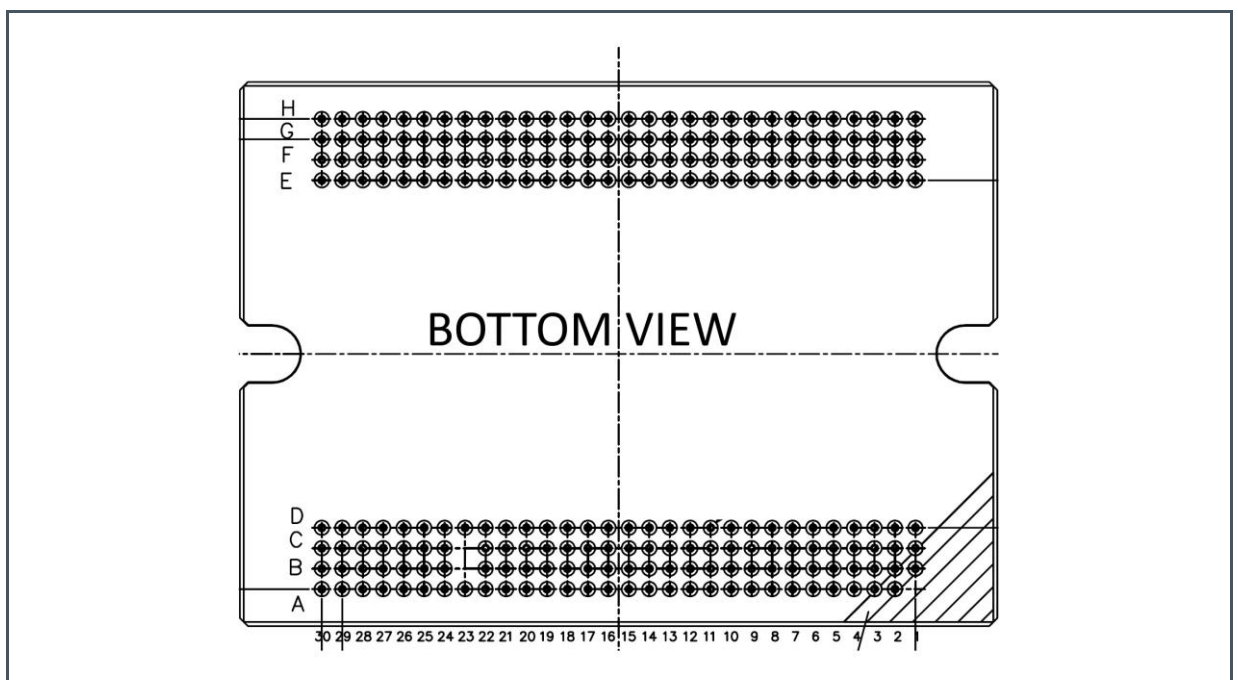

3.2 Pin Description

Figure 4:
Pin Description of CMV12000

Number	Name	Type	Description
A2	TANA	Analog output	Test pin for analog pixel signals (do not connect)
A3	VREF	Bias	Reference for column amps (decouple with 100 nF to GND)
A4	VPCH_L	Bias	Pre-charge low voltage (decouple with 100 nF to GND)
A5	OUTCTR_N	LVDS output	LVDS negative control channel output
A6	OUTCTR_P	LVDS output	LVDS positive control channel output
A7	OUT2_N	LVDS output	LVDS negative output channel 2
A8	OUT2_P	LVDS output	LVDS positive output channel 2
A9	GND	Ground	Ground pin

Number	Name	Type	Description
A10	VDD18	Supply	1.98 V supply
A11	OUT9_N	LVDS output	LVDS negative output channel 9
A12	OUT9_P	LVDS output	LVDS positive output channel 9
A13	OUT13_N	LVDS output	LVDS negative output channel 13
A14	OUT13_P	LVDS output	LVDS positive output channel 13
A15	VDD18	Supply	1.98 V supply
A16	VDD18	Supply	1.98 V supply
A17	OUT19_N	LVDS output	LVDS negative output channel 19
A18	OUT19_P	LVDS output	LVDS positive output channel 19
A19	OUT23_N	LVDS output	LVDS negative output channel 23
A20	OUT23_P	LVDS output	LVDS positive output channel 23
A21	GND	Ground	Ground pin
A22	VDD18	Supply	1.98 V supply
A23	OUT29_N	LVDS output	LVDS negative output channel 29
A24	OUT29_P	LVDS output	LVDS positive output channel 29
A25	GND	Ground	Ground pin
A26	VDD18	Supply	1.98 V supply
A27	VDD18	Supply	1.98 V supply
A28	GND	Ground	Ground pin
A29	GND	Ground	Ground pin
A30	VDD_PIX	Supply	3.0 V supply
B1	CMD_COL_LOAD	Bias	Decouple with 100 nF to VDD33
B2	VTREF	Analog input	Test pin (decouple with 100 nF to GND)
B3	VREF_ADC	Bias	Reference for ADC (decouple with 100 nF to GND)
B4	VDD18	Supply	1.98 V supply
B5	GND	Ground	Ground pin
B6	OUT1_N	LVDS output	LVDS negative output channel 1
B7	OUT1_P	LVDS output	LVDS positive output channel 1
B8	OUT5_N	LVDS output	LVDS negative output channel 5
B9	OUT5_P	LVDS output	LVDS positive output channel 5
B10	OUT8_N	LVDS output	LVDS negative output channel 8
B11	OUT8_P	LVDS output	LVDS positive output channel 8
B12	OUT12_N	LVDS output	LVDS negative output channel 12
B13	OUT12_P	LVDS output	LVDS positive output channel 12
B14	OUT16_N	LVDS output	LVDS negative output channel 16
B15	OUT16_P	LVDS output	LVDS positive output channel 16
B16	OUT18_N	LVDS output	LVDS negative output channel 18
B17	OUT18_P	LVDS output	LVDS positive output channel 18
B18	OUT22_N	LVDS output	LVDS negative output channel 22
B19	OUT22_P	LVDS output	LVDS positive output channel 22

Number	Name	Type	Description
B20	OUT26_N	LVDS output	LVDS negative output channel 26
B21	OUT26_P	LVDS output	LVDS positive output channel 26
B22	GND	Ground	Ground pin
B24	OUT31_N	LVDS output	LVDS negative output channel 31
B25	OUT31_P	LVDS output	LVDS positive output channel 31
B26	GND	Ground	Ground pin
B27	GND	Ground	Ground pin
B28	GND	Ground	Ground pin
B29	CMD_RAMP	Bias	Decouple with 100 nF to VDD33
B30	VTF_LOW2	Bias	Transfer low voltage 2 (decouple with 100 nF to GND)
C1	CMD_LVDS	Bias	Decouple with 100 nF to GND
C2	VTSIG	Analog input	Test pin (decouple with 100 nF to GND)
C3	VCM_COMP33	Bias	Decouple with 100 nF to GND
C4	VPCH_H	Bias	Pre-charge high voltage (decouple with 100 nF to GND)
C5	VTF_LOW0	Bias	Transfer low voltage 0 (connect to GND)
C6	CMD_COLAMP	Bias	Decouple with 100 nF to VDD33
C7	OUT4_N	LVDS output	LVDS negative output channel 4
C8	OUT4_P	LVDS output	LVDS positive output channel 4
C9	OUT7_N	LVDS output	LVDS negative output channel 7
C10	OUT7_P	LVDS output	LVDS positive output channel 7
C11	OUT11_N	LVDS output	LVDS negative output channel 11
C12	OUT11_P	LVDS output	LVDS positive output channel 11
C13	OUT14_N	LVDS output	LVDS negative output channel 14
C14	OUT14_P	LVDS output	LVDS positive output channel 14
C15	GND	Ground	Ground pin
C16	GND	Ground	Ground pin
C17	OUT21_N	LVDS output	LVDS negative output channel 21
C18	OUT21_P	LVDS output	LVDS positive output channel 21
C19	OUT25_N	LVDS output	LVDS negative output channel 25
C20	OUT25_P	LVDS output	LVDS positive output channel 25
C21	OUT28_N	LVDS output	LVDS negative output channel 28
C22	OUT28_P	LVDS output	LVDS positive output channel 28
C24	OUT32_N	LVDS output	LVDS negative output channel 32
C25	OUT32_P	LVDS output	LVDS positive output channel 32
C26	VDD33	Supply	3.3 V supply
C27	VDD33	Supply	3.3 V supply
C28	GND	Ground	Ground pin
C29	VBGAP	Bias	Decouple with 100 nF to GND
C30	VTF_LOW3	Bias	Transfer low voltage 3 (decouple with 100 nF to GND)
D1	CMD_COL_PC	Bias	Decouple with 100 nF to VDD33

Number	Name	Type	Description
D2	GND	Ground	Ground pin
D3	VDD33	Supply	3.3 V supply
D4	VCLAMP	Bias	Decouple with 100 nF to GND
D5	VRES_L	Bias	Reset low voltage (decouple with 100 nF to GND)
D6	VTF_LOW1	Bias	Transfer low voltage 1 (connect to GND)
D7	OUT3_N	LVDS output	LVDS negative output channel 3
D8	OUT3_P	LVDS output	LVDS positive output channel 3
D9	OUT6_N	LVDS output	LVDS negative output channel 6
D10	OUT6_P	LVDS output	LVDS positive output channel 6
D11	OUT10_N	LVDS output	LVDS negative output channel 10
D12	OUT10_P	LVDS output	LVDS positive output channel 10
D13	OUT15_N	LVDS output	LVDS negative output channel 15
D14	OUT15_P	LVDS output	LVDS positive output channel 15
D15	OUT17_N	LVDS output	LVDS negative output channel 17
D16	OUT17_P	LVDS output	LVDS positive output channel 17
D17	OUT20_N	LVDS output	LVDS negative output channel 20
D18	OUT20_P	LVDS output	LVDS positive output channel 20
D19	OUT24_N	LVDS output	LVDS negative output channel 24
D20	OUT24_P	LVDS output	LVDS positive output channel 24
D21	OUT27_N	LVDS output	LVDS negative output channel 27
D22	OUT27_P	LVDS output	LVDS positive output channel 27
D23	OUT30_N	LVDS output	LVDS negative output channel 30
D24	OUT30_P	LVDS output	LVDS positive output channel 30
D25	GND	Ground	Ground pin
D26	VDD33	Supply	3.3 V supply
D27	GND	Ground	Ground pin
D28	VDD_PIX	Supply	3.0 V supply
D29	GND	Ground	Ground pin
D30	VDD_PIX	Supply	3.0 V supply
E1	VDD18_PLL	Supply	PLL 1.98 V supply (unused)
E2	VDD_RES	Supply	3.3 V supply
E3	GND	Ground	Ground pin
E4	DIO2	Ground	Connect to ground
E5	LVDS_CLK_N	LVDS input	LVDS input clock N
E6	LVDS_CLK_P	LVDS input	LVDS input clock P
E7	OUT35_N	LVDS output	LVDS negative output channel 35
E8	OUT35_P	LVDS output	LVDS positive output channel 35
E9	OUT38_N	LVDS output	LVDS negative output channel 38
E10	OUT38_P	LVDS output	LVDS positive output channel 38
E11	OUT42_N	LVDS output	LVDS negative output channel 42

Number	Name	Type	Description
E12	OUT42_P	LVDS output	LVDS positive output channel 42
E13	OUT46_N	LVDS output	LVDS negative output channel 46
E14	OUT46_P	LVDS output	LVDS positive output channel 46
E15	GND	Ground	Ground pin
E16	GND	Ground	Ground pin
E17	OUT51_N	LVDS output	LVDS negative output channel 51
E18	OUT51_P	LVDS output	LVDS positive output channel 51
E19	OUT55_N	LVDS output	LVDS negative output channel 55
E20	OUT55_P	LVDS output	LVDS positive output channel 55
E21	OUT59_N	LVDS output	LVDS negative output channel 59
E22	OUT59_P	LVDS output	LVDS positive output channel 59
E23	OUT62_N	LVDS output	LVDS negative output channel 62
E24	OUT62_P	LVDS output	LVDS positive output channel 62
E25	GND	Ground	Ground pin
E26	VDD33	Supply	3.3 V supply
E27	GND	Ground	Ground pin
E28	SPI_IN	Digital input	SPI data input pin
E29	T_EXP2	Digital input	Input pin for external exposure
E30	CLK_IN	Digital input	Master input clock
F1	CMDN	Bias	Decouple with 100 nF to GND
F2	CMDP	Bias	Decouple with 100 nF to VDD33
F3	CMDP_COMP18	Bias	Decouple with 100 nF to VDD33
F4	DIO1	Ground	Connect to ground
F5	VDD33	Supply	3.3 V supply
F6	OUT33_N	LVDS output	LVDS negative output channel 33
F7	OUT33_P	LVDS output	LVDS positive output channel 33
F8	OUT37_N	LVDS output	LVDS negative output channel 37
F9	OUT37_P	LVDS output	LVDS positive output channel 37
F10	OUT40_N	LVDS output	LVDS negative output channel 40
F11	OUT40_P	LVDS output	LVDS positive output channel 40
F12	OUT44_N	LVDS output	LVDS negative output channel 44
F13	OUT44_P	LVDS output	LVDS positive output channel 44
F14	OUT48_N	LVDS output	LVDS negative output channel 48
F15	OUT48_P	LVDS output	LVDS positive output channel 48
F16	OUT49_N	LVDS output	LVDS negative output channel 49
F17	OUT49_P	LVDS output	LVDS positive output channel 49
F18	OUT53_N	LVDS output	LVDS negative output channel 53
F19	OUT53_P	LVDS output	LVDS positive output channel 53
F20	OUT57_N	LVDS output	LVDS negative output channel 57
F21	OUT57_P	LVDS output	LVDS positive output channel 57

Number	Name	Type	Description
F22	OUT60_N	LVDS output	LVDS negative output channel 60
F23	OUT60_P	LVDS output	LVDS positive output channel 60
F24	NC		Not connected
F25	NC		Not connected
F26	VDD33	Supply	3.3 V supply
F27	GND	Ground	Ground pin
F28	SPI_EN	Digital input	SPI enable input pin
F29	VRAMP2	Bias	Start voltage second ramp (decouple with 100 nF to GND)
F30	SYS_RES_N	Digital input	Input pin for sequencer reset
G1	VDD_PIX	Supply	3.0 V supply
G2	CMDN_OSC	Bias	Decouple with 100 nF to GND
G3	DIO4	Ground	Connect to ground
G4	VDD_RES	Supply	3.3 V supply
G5	GND	Ground	Ground pin
G6	OUTCLK_N	LVDS output	LVDS negative clock output signal
G7	OUTCLK_P	LVDS output	LVDS positive clock output signal
G8	OUT36_N	LVDS output	LVDS negative output channel 36
G9	OUT36_P	LVDS output	LVDS positive output channel 36
G10	OUT39_N	LVDS output	LVDS negative output channel 39
G11	OUT39_P	LVDS output	LVDS positive output channel 39
G12	OUT43_N	LVDS output	LVDS negative output channel 43
G13	OUT43_P	LVDS output	LVDS positive output channel 43
G14	OUT47_N	LVDS output	LVDS negative output channel 47
G15	OUT47_P	LVDS output	LVDS positive output channel 47
G16	OUT50_N	LVDS output	LVDS negative output channel 50
G17	OUT50_P	LVDS output	LVDS positive output channel 50
G18	OUT54_N	LVDS output	LVDS negative output channel 54
G19	OUT54_P	LVDS output	LVDS positive output channel 54
G20	OUT58_N	LVDS output	LVDS negative output channel 58
G21	OUT58_P	LVDS output	LVDS positive output channel 58
G22	OUT61_N	LVDS output	LVDS negative output channel 61
G23	OUT61_P	LVDS output	LVDS positive output channel 61
G24	OUT64_N	LVDS output	LVDS negative output channel 64
G25	OUT64_P	LVDS output	LVDS positive output channel 64
G26	TDIG2	Digital output	Test pin for digital sequencer signals (do not connect)
G27	TDIG1	Digital output	Test pin for digital sequencer signals (do not connect)
G28	SPI_OUT	Digital output	SPI data output pin
G29	VRAMP1	Bias	Start voltage first ramp (decouple with 100 nF to GND)
G30	FRAME_REQ	Digital input	Frame request pin
H1	GND	Ground	Ground pin

Number	Name	Type	Description
H2	CMDP_OSC	Bias	Decouple with 100 nF to VDD18
H3	CMDP_COMP33	Bias	Decouple with 100 nF to VDD33
H4	DIO3	Ground	Connect to ground
H5	VDD18	Supply	1.98 V supply
H6	GND	Ground	Ground pin
H7	OUT34_N	LVDS output	LVDS negative output channel 34
H8	OUT34_P	LVDS output	LVDS positive output channel 34
H9	GND	Ground	Ground pin
H10	VDD18	Supply	1.98 V supply
H11	OUT41_N	LVDS output	LVDS negative output channel 41
H12	OUT41_P	LVDS output	LVDS positive output channel 41
H13	OUT45_N	LVDS output	LVDS negative output channel 45
H14	OUT45_P	LVDS output	LVDS positive output channel 45
H15	VDD18	Supply	1.98 V supply
H16	VDD18	Supply	1.98 V supply
H17	OUT52_N	LVDS output	LVDS negative output channel 52
H18	OUT52_P	LVDS output	LVDS positive output channel 52
H19	OUT56_N	LVDS output	LVDS negative output channel 56
H20	OUT56_P	LVDS output	LVDS positive output channel 56
H21	GND	Ground	Ground pin
H22	VDD18	Supply	1.98 V supply
H23	OUT63_N	LVDS output	LVDS negative output channel 63
H24	OUT63_P	LVDS output	LVDS positive output channel 63
H25	GND	Ground	Ground pin
H26	VDD18	Supply	1.98 V supply
H27	GND	Ground	Ground pin
H28	VDD_PIX	Supply	3.0 V supply
H29	SPI_CLK	Digital input	SPI clock input pin
H30	T_EXP1	Digital input	Input pin for external exposure

4 Absolute Maximum Ratings

Stresses beyond those listed under “Absolute Maximum Ratings” may cause permanent damage to the device. These are stress ratings only. Functional operation of the device at these or any other conditions beyond those indicated under “Operating Conditions” is not implied. Exposure to absolute maximum rating conditions for extended periods may affect device reliability.

Figure 5:
Absolute Maximum Ratings of CMV12000

Symbol	Parameter	Min	Max	Unit	Comments
Electrical Parameters					
VDD18	Digital supply LVDS, ADC	1.8	2.0	V	
VDD33	Analog Supply ADC, PGA	3.0	3.6	V	
VDD_PIX	Analog Pixel Supply	2.3	3.6	V	
VDD_RES	Analog Pixel Reset Supply	3.0	3.6	V	
Continuous Power Dissipation (T_A = 70 °C)					
P _T	Continuous Power Dissipation		4200	mW	At max. frame rate
Electrostatic Discharge					
ESD _{HBM}	Electrostatic Discharge HBM	±2000		V	JS-001-2012 Class 2
Temperature Ranges and Storage Conditions					
T _J	Operating Junction Temperature	-30	70	°C	
T _{STRG}	Storage Temperature Range	20	40	°C	
RH _{NC}	Relative Humidity (non-condensing)	30	60	%	Storage conditions

5 Electrical Characteristics

Figure 6:
 Electrical Characteristics of CMV12000

Symbol	Parameter	Conditions	Min	Typ	Max	Unit
Power Supplies						
VDD18	Digital supply LVDS, ADC		1.95	1.98	1.98	V
VDD33	Analog supply ADC, PGA		3.2	3.3	3.4	V
VDD_PIX	Analog pixel supply		2.9	3.0	3.1	V
VDD_RES	Analog pixel reset supply		3.2	3.3	3.4	V
IDD18	Supply current	Readout Peak		750 1700		mA
IDD33	Supply current	Readout Peak		180 250		mA
IDD_PIX	Supply current	Readout Peak		15 1000 ⁽¹⁾		mA
IDD_RES	Supply current	Readout Peak		25 200		mA
Digital I/O						
V _{IH}	High level Input		2.0		VDD33	V
V _{IL}	Low level input		GND		0.8	V
V _{OH}	High level output	VDD=3.3 V I _{OH} = -2 mA	2.4			V
V _{OL}	Low level output	VDD=3.3 V I _{OH} = 2 mA			0.4	V
f _{SPI}	SPI clock				30	MHz
f _{CLK}	Temp. sensor ⁽²⁾ input clock		10		60	MHz
LVDS I/O						
V _{ID}	Differential input voltage	Steady state	100	350	600	mV
V _{IC}	Receiver input range	Steady state	0.0		2.4	V

Symbol	Parameter	Conditions	Min	Typ	Max	Unit
I_{ID}	Receiver input current	$V_{INP INN}=1.2\text{ V}\pm 50\text{ mV}$, $0 \leq V_{INP INN} \leq 2.4\text{ V}$			20	μA
ΔI_{ID}	Receiver input current difference	$ I_{INP} - I_{INN} $			6	μA
V_{OD}	Differential output voltage	Steady state, $R_{load} = 100\ \Omega$	247	350	454	mV
ΔV_{OD}	Difference in V_{OD} between complementary output states	Steady state, $R_{load} = 100\ \Omega$			50	mV
V_{OC}	Common mode voltage	Steady state, $R_{load} = 100\ \Omega$	1.125	1.25	1.375	V
ΔV_{OC}	Difference in V_{OC} between complementary output states	Steady state, $R_{load} = 100\ \Omega$			50	mV
$I_{OS,GND}$	Output short circuit current to ground	$V_{OUTP}=V_{OUTN}=GND$			24	mA
$I_{OS,PN}$	Output short circuit current	$V_{OUTP}=V_{OUTN}$			12	mA
f_{LVDS}	LVDS input clock frequency		100		600	MHz

- (1) This is a short peak during FOT, at the global shutter reset of all pixels. This peak has to be supplied by enough decoupling capacitors.
- (2) Optional input clock at pin CLK_IN for the temperature sensor

6 Typical Operating Characteristics

6.1 Electro-Optical Characteristics

Below are the typical electro-optical specifications of the CMV12000. These are typical values for the whole operating temperature range unless otherwise specified.

Figure 7:
Electro-Optical Characteristics

Parameter	Value	Remark
Effective pixels	4096 × 3072	
Pixel pitch	5.5 μm × 5.5 μm	
Optical format	APS-like	28.16 mm
Pixel type	Global shutter with true CDS	Allows fixed pattern noise correction and reset (kTC) noise canceling by true correlated double sampling (true-CDS).
Shutter type	Pipelined global shutter	Exposure of next image during readout of the previous image.
Full well charge	13500 e	Pixel full well charge
Conversion gain	0.11 DN/e	10b, unity gain
Sensitivity	4.64 V/lux.s 0.22 A/W	@555 nm
Temporal noise	13 e	
Dynamic range	60 dB	
SNR _{MAX}	41.3 dB	
Shutter efficiency	1/50000	@555 nm
Dark current	70 e/s	@ 25 °C junction temperature DC doubles every 6.5 °C increase
DCNU	7.5 e/s	@ 25°C sensor temperature; DC Non Uniformity
FPN	<1 LSB	<0.1 % of full swing in 10b mode; Fixed Pattern Noise
PRNU	< 1.27 % RMS	Photo Response Non Uniformity; RMS of signal
Color filters	Optional	RGB Bayer pattern
QE	50 %	Monochrome device @ 555 nm; Quantum Efficiency
LVDS outputs	64 Data 1 Control 1 Clock	Each data output running @600 Mbit/s maximum. Less outputs selectable at reduced frame rate
Frame rate	300 fps	Using 10-bit mode at 600 Mbit/s Higher frame rate possible in row windowing mode.
Timing generation	On-chip	Possibility to control exposure time through external pin.
PGA	Yes	x1, x2, x3, x4 analog gain settings
Programmable registers	Sensor parameters	Window coordinates, Timing parameters, Gain & offset, Exposure time,

Parameter	Value	Remark
HDR mode	Interleaved Multiple slope	2 exposure times for odd/even columns Partial pixel reset
ADC	8/10/12-bit	Column ADC
Interface	LVDS; 600 Mbit/s	Serial output data + synchronization signals
I/O logic levels	LVDS = 1.8 V Dig. I/O = 3.3 V	
Cover glass	D263T eco	Double sided AR coating T \geq 97.0 % abs, 400 - 900 nm, per surface, AOI=15°
Mass	15.2 g	

6.2 Spectral Characteristics

Figure 8:
Quantum Efficiency

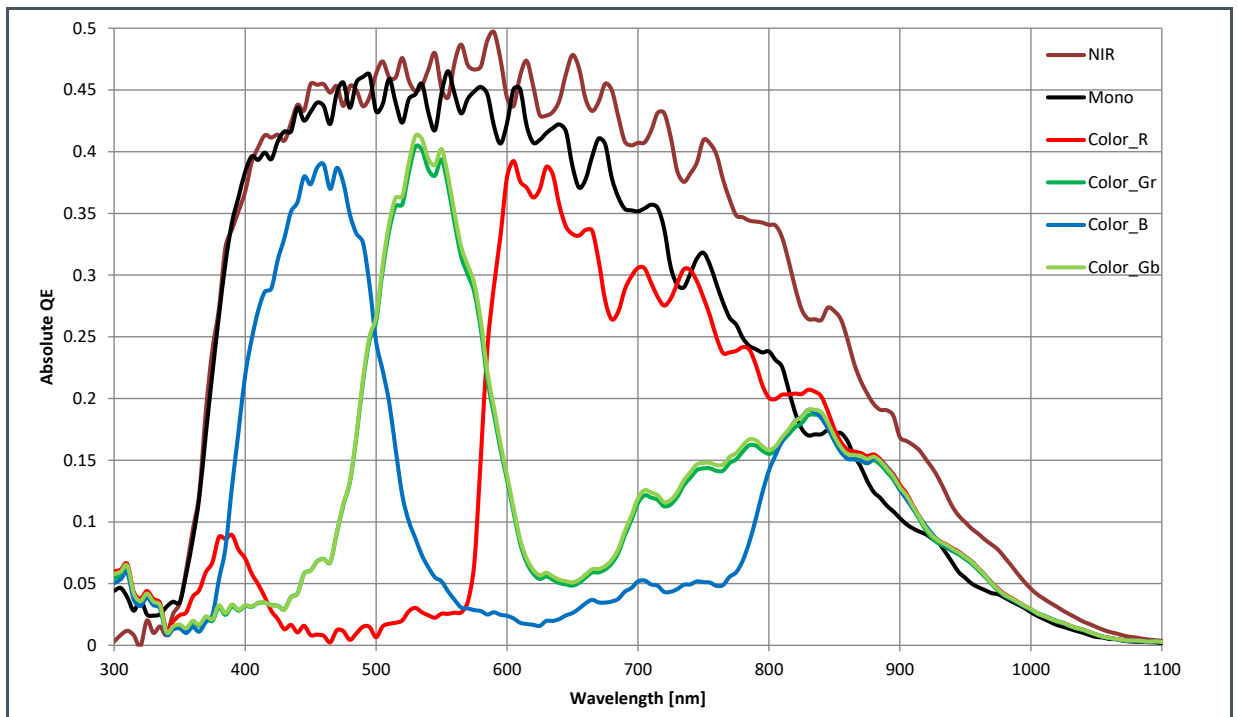

Figure 9:
Spectral Response

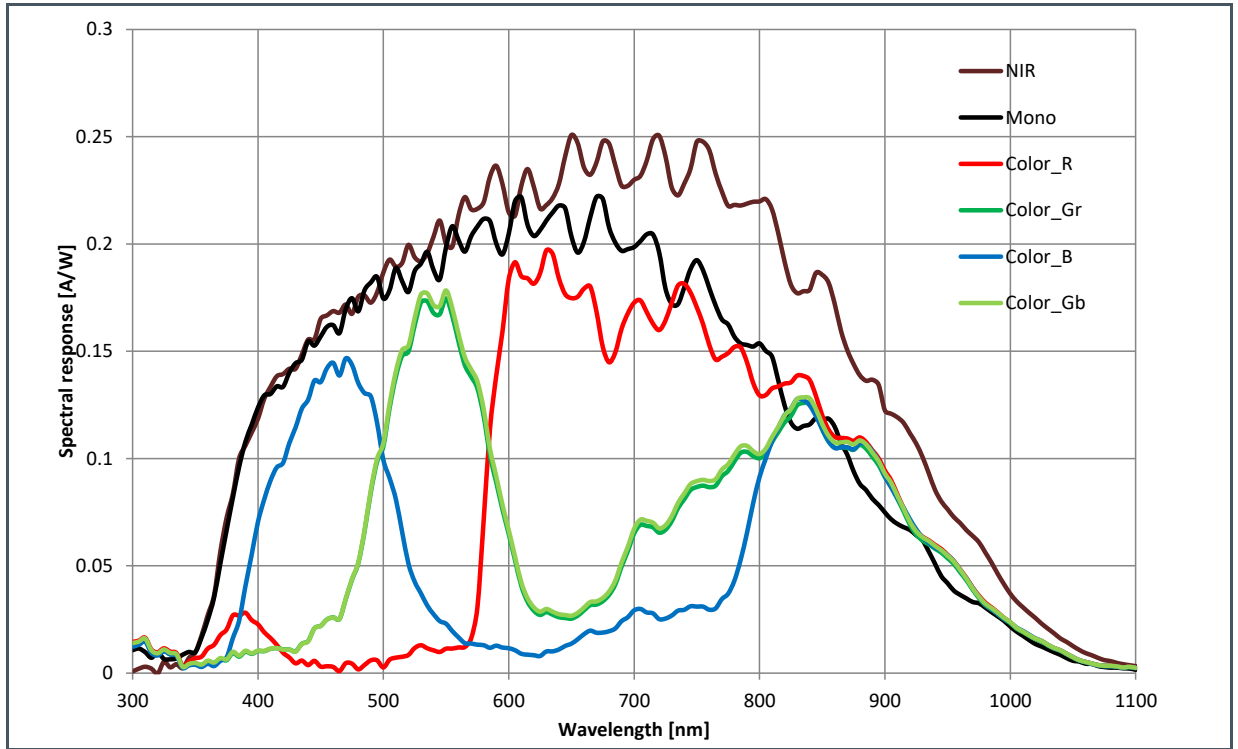
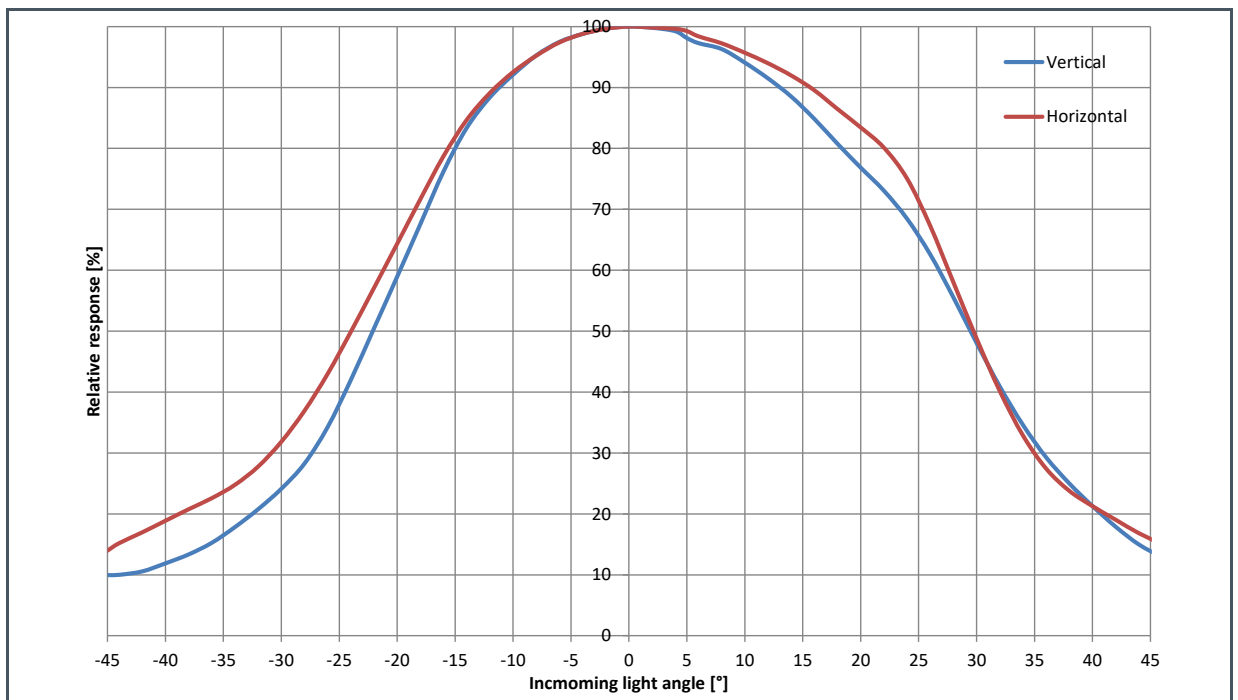

Figure 10:
Angular Response



7 Functional Description

7.1 Sensor Architecture

Figure 2 shows the image sensor architecture. The internal sequencer generates the necessary signals for image acquisition. The image is stored in the pixel (global shutter) and they are read out sequentially, row-by-row. On the pixel output, an analog gain is possible. The pixel values then pass to a column ADC cell, in which ADC conversion is performed. The digital signals are then read out over multiple LVDS channels. Each LVDS channel reads out 128 adjacent columns of the array. The read-out of the pixel array is performed on both sides (top and bottom) of the pixel array to speed up the read-out process and achieve the frame rate of 300 fps at full resolution and 10-bit. In each line read-out cycle, two lines are selected for read-out. In the Y-direction, rows of interest are selected through a row-decoder, which allows a flexible windowing. Control registers are foreseen for the programming of the sensor. These register parameters are uploaded via a four-wire SPI interface. A temperature sensor, which can be read out over the SPI interface, is also included.

7.1.1 Pixel Array

The pixel array consists of 4096 x 3072 square global shutter pixels with a pitch of 5.5 μm (5.5 μm x 5.5 μm). This results in an optical area of 22.5 mm x 16.9 mm (28.1 mm diameter).

The pixels are designed to achieve maximum sensitivity with low noise (using CDS) and low PLS specifications. Micro lenses are placed on top of the pixels for improved fill factor and quantum efficiency.

There are 16 dark reference columns available on the sensor (columns 0 to 7 and 4088 to 4095) which can be enabled/disabled by programming the appropriate sensor register.

7.1.2 Analog Front End

The analog front end consists of two major parts, a column amplifier block and a column ADC block.

The column amplifier prepares the pixel signal for the column ADC and applies analog gain if desired (programmable using the SPI interface). The column ADC converts the analog pixel value to an 8-, 10- or 12-bit value and can apply a gain. A digital offset can also be applied to the output of the column ADCs. All gain and offset settings can be programmed using the SPI interface.

7.1.3 LVDS Block

The LVDS block converts the digital data coming from the column ADC into standard serial LVDS data running at maximum 600 Mbit/s. The sensor has 66 LVDS output pairs:

- 64 Data channels
- 1 Control channel
- 1 Clock channel

The 64 data channels are used to transfer 8-bit, 10-bit or 12-bit data words from sensor to receiver. The output clock channel transports a DDR clock (max 300 MHz), synchronous to the data on the other LVDS channels. This clock can be used at the receiving end to sample the data. The data on the control channel contains status information on the validity of the data on the data channels, among other useful sensor status information. Details on the LVDS timing and format can be found in section 7.3 of this document.

7.1.4 Sequencer

The on-chip sequencer will generate all required control signals to operate the sensor from only a few external control signals. This sequencer can be activated and programmed through the SPI interface.

7.1.5 SPI Interface

The SPI interface is used to load the sequencer registers with data. The data in these registers is used by the sequencer while driving and reading out the image sensor. Features like windowing, subsampling, gain and offset are programmed using this interface. The data in the on-chip registers can also be read back for test and debug of the surrounding system.

7.1.6 Temperature Sensor

A 16-bit digital temperature sensor is included in the image sensor and can be controlled by the SPI-interface. The on-chip temperature can be obtained by reading out the register with address 127.

7.2 Operating the Sensor

This section explains how to connect and power the sensor, as well as basic recipes of how to configure the sensor in a certain operation mode.



Information

All register values are in decimal notation unless otherwise specified.

7.2.1 Power Supplies

To power the sensor, five externally generated supplies are required (VDD18, VDD33, VDD_PIX and VDD_RES).

It is recommended to decouple every physical supply pin at the sensor with a 100 nF ceramic capacitor per pin. As VDD18 and VDD_PIX draw large peak currents it is also recommended to add a larger (>10 µF) local capacitor close to the sensor for those supplies. At the voltage regulator side also enough bulk decoupling has to be foreseen.

VDD18 draws its peak current every read out line. The peak current decreases with lower data rates. Care has to be taken in the supply and decoupling design so that VDD18 is always above 1.93 V during these peaks (so max. 50 mV dip) to guarantee sensor performance. The voltage regulator should be able to handle the 1.7 A.

VDD_PIX draws a short but large peak current during FOT. Care has to be taken in the supply and decoupling design so that VDD_PIX is always above 2.9 V during these peaks (so max. 100 mV dip) to guarantee sensor performance. The peak current should be handled by the decoupling capacitors, not the voltage regulator.

For VDD33 and VDD_RES the peak currents are lower, but still care has to be taken not allowing the voltages dips outside the voltage range.

The voltage required is the voltage on the supplies to guarantee the best sensor performance. The voltage range is the range the voltage should stay within (so during current peaks) to guarantee sensor performance. If the supply is outside the voltage range, the sensor might still be functional but performance is not guaranteed. The voltage absolute maximum is the range outside which (permanent) sensor malfunction might occur.

For more details on the power figures and peak plots, an application note is available. This supply needs therefor decent decoupling to dampen the current peak.

The sensor will heat up above ambient (+ ~20/40 °C idle/running at 600 MHz). Therefore decent system heat management is needed to keep the sensor junction temperature below the specifications limit of 70 °C.

7.2.2 Biasing

For optimal performance, some bias pins need to be decoupled to ground or to VDD. Please refer to the pin list for a detailed description for every pin and the appropriate decoupling.

7.2.3 Digital Input Pins

The table below gives an overview of the external pins used to operate the sensor.

Figure 11:
Digital Input Pins

Pin Name	Description
CLK_IN	Optional input clock, frequency range between 10 MHz and 60 MHz. Only needed for the internal temperature sensor.

Pin Name	Description
LVDS_CLK_P/N	Input clock, frequency range between 100 MHz and 600 MHz, depending on the bit mode.
SYS_RES_N	System reset pin, active low signal. Resets the on-board sequencer and must be kept low during start-up
FRAME_REQ	Frame request pin. When a high state is detected on this pin, the programmed number of frames is captured and sent by the sensor. The pulse should be at least 8, 10 or 12 * LVDS input clock periods wide to be detected, depending on the used bit mode.
SPI_IN	Data input pin for the SPI interface. The data to program the image sensor is sent over this pin.
SPI_EN	SPI enable pin. When this pin is high the data should be written/read on the SPI
SPI_CLK	SPI clock. This is the clock on which the SPI runs (max 30 MHz)
T_EXP1	Input pin, which can be used to program the exposure time externally. The pulse should be at least 8, 10 or 12 * LVDS input clock periods wide to be detected, depending on the used bit mode. Optional
T_EXP2	Input pin, which can be used to program the exposure time externally in interleaved high dynamic range mode. The pulse should be at least 8, 10 or 12 * LVDS input clock periods wide to be detected, depending on the used bit mode. Optional

7.2.4 Clocking

The LVDS input clock defines the output data rate of the CMV12000. The maximum data rate of the output is 600 Mbit/s (DDR 300MHz output clock) which results in an input LVDS_CLK clock of 600 MHz. The minimum LVDS_CLK_P/N frequency is 100 MHz for 12-bit, 10-bit and 8-bit. At lower frequencies, image performance will decrease. Any input frequency (min <math>f < \text{max}</math>) applied (in MHz) will result in a corresponding output data rate (in Mbit/s). Some register settings need to be changed when changing the input clock frequency from 600 MHz. See section 7.7.4.

7.2.5 Startup Sequence

The following sequence should be followed when the device is started up.

Figure 12:
Startup Sequence

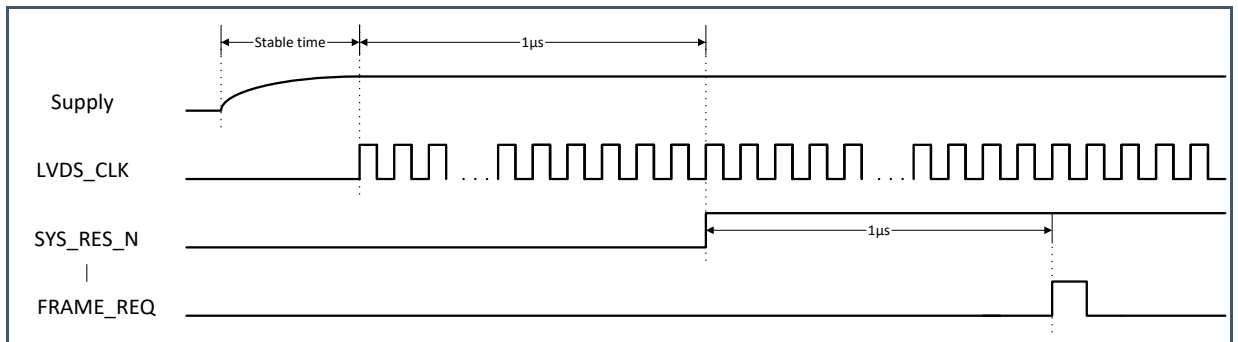

The LVDS input clock should only start after the rise time of the supplies. The external reset pin should be released at least 1 μ s after the supplies have become stable. The first frame can be requested 1 μ s after the reset pin has been released. An optional SPI upload (to program the sequencer) is possible 1 μ s after the reset pin has been released. In this case, the FRAME_REQ pulse must be postponed until after the SPI upload has been completed.

7.2.6 Reset Sequence

If a sensor reset is necessary while the sensor is running, the next sequence should be followed.

Figure 13:
Reset Sequence

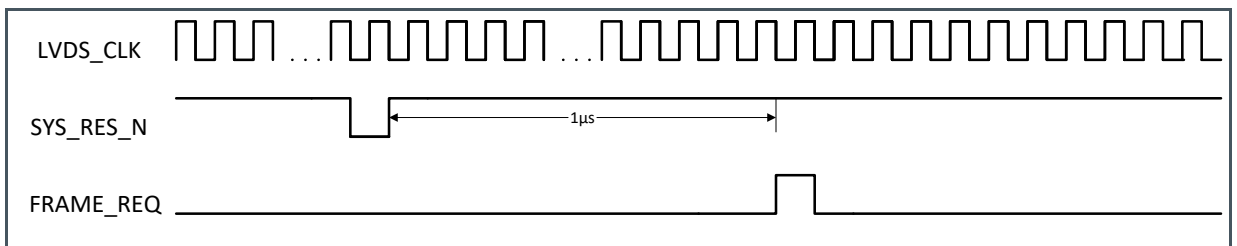

The on-board sequencer will be reset and all programming registers will return to their default start-up values when a falling edge is detected on the SYS_RES_N pin. After the reset there is a minimum time of 1 μ s needed, before a FRAME_REQ pulse can be sent.

When a switch from 12-bit to 10-bit or 8-bit mode (or vice versa) is necessary, the following sequence should be followed.

Figure 14:
Reset Sequence with Changing Bit Mode

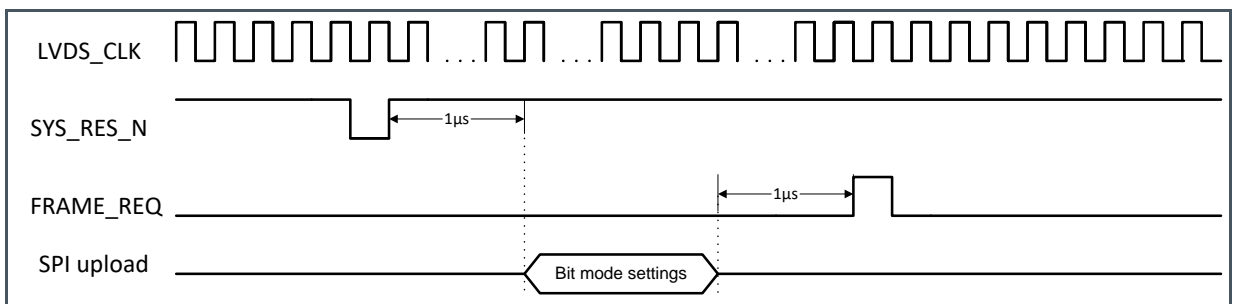

The following SPI register should be uploaded in this mode: Bit_mode (address 118): set to desired bit resolution mode.

7.2.7 SPI Programming

Programming the sensor is done by writing the appropriate values to the on-board registers. These registers can be written over a simple serial interface (SPI). The details of the timing and data format are described below. The data written to the programming registers can also be read out over this same SPI interface.

SPI I/O's are pulled low when not used/enabled.

SPI Write

The timing to write data over the SPI interface can be found below.

Figure 15:
SPI Write

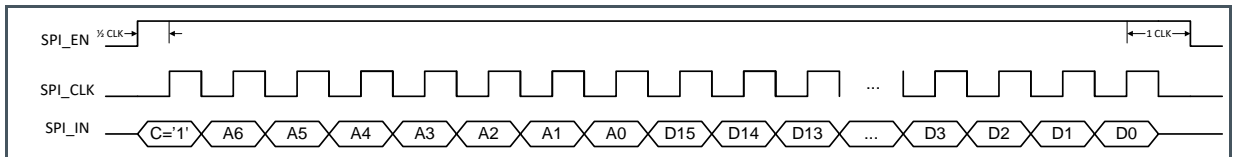

The data is sampled by the device on the rising edge of the SPI_CLK and read-in at the last falling SPI_CLK edge. The SPI_CLK has a maximum frequency of 30 MHz. The SPI_EN signal has to be high for half a clock period before the first data bit is sampled. SPI_EN has to remain high for one clock period after the last data bit is sampled.

One write action contains 24 data bits:

- One control bit: First bit to be sent, indicates whether a read ('0') or write ('1') will occur on the SPI interface.
- 7 address bits: These bits form the address of the programming register that needs to be written. The address is sent MSB first.
- 16 data bits: These bits form the actual data that will be written in the register selected with the address bits. The data is written MSB first.

When several sensor registers need to be written, the timing above can be repeated with SPI_EN remaining high all the time. See the figure below for an example of 2 registers being written.

Figure 16:
SPI Write of Multiple Registers

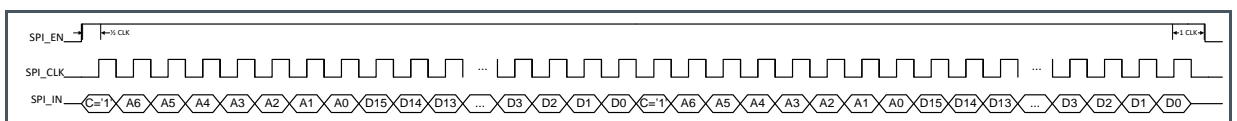

SPI Read

The timing to read data from the registers over the SPI interface can be found below.

Figure 17:
SPI Read

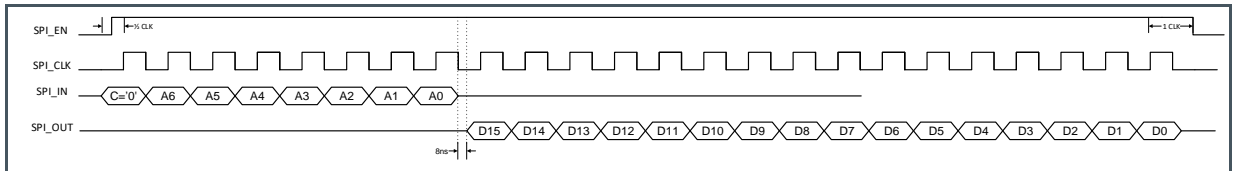

To indicate a read action over the SPI interface, the control bit on the SPI_IN pin is made '0'. The address of the register being read out is sent immediately after this control bit (MSB first). After the LSB of the address bits, the data is launched on the SPI_OUT pin on the falling edge of the SPI_CLK with an 8 ns delay (independent of SPI or sensor clock speeds). This means that the data can be sampled by the receiving system on the rising edge of the SPI_CLK. The data comes over the SPI_OUT with MSB first.

7.2.8 Requesting a Frame

After starting up the sensor, a number of frames can be requested by sending a FRAME_REQ pulse. The number of frames can be set by programming the appropriate register (address 80). The default number of frames to be grabbed is 1.

In internal exposure mode, the exposure time will start after this FRAME_REQ pulse. In the external exposure mode, the read-out will start after the FRAME_REQ pulse. Both modes are explained into detail in the sections below.

Internal Exposure Control

In this mode, the exposure time is set by programming the appropriate register (addresses 71-72) of the device.

After the high state of the FRAME_REQ pulse is detected, the exposure time will start immediately. When the exposure time ends (as programmed in the registers), the pixels are being sampled and prepared for read-out. This sequence is called the frame overhead time (FOT). Immediately after the FOT, the frame is read out automatically. If more than one frame is requested, the exposure of the next frame starts already during the read-out of the previous one. See the diagram below for more details.

Figure 18:
Internal Exposure Request for Two Frames

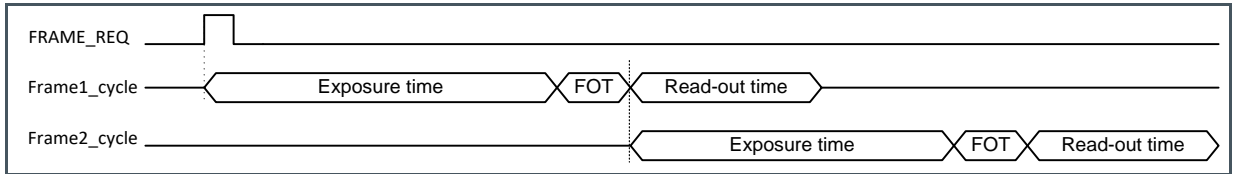

When the exposure time is shorter than the read-out time, the FOT and read-out of the next frame will start immediately after the read-out of the previous frame.

Figure 19:
Internal Exposure Request for Two Frames with Short Exposure Time

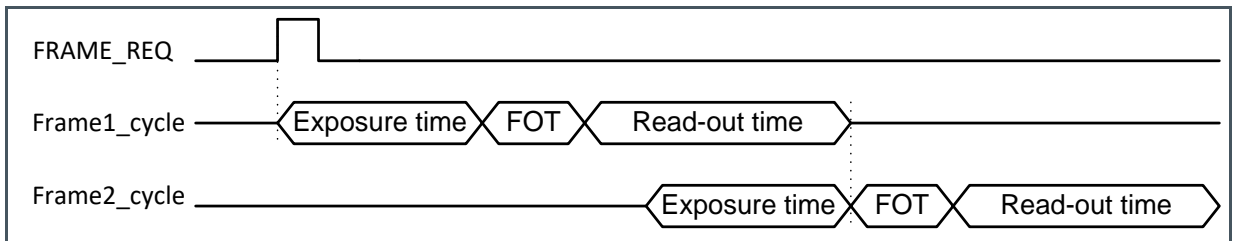

When you request a second frame during the read-out of the current frame, the current read-out will always be finished before the FOT of the new requested frame starts. When the new Frame_REQ pulse is too early, it will be delayed internally so that the FOT starts immediately after the readout.

Figure 20:
Internal Exposure Delay

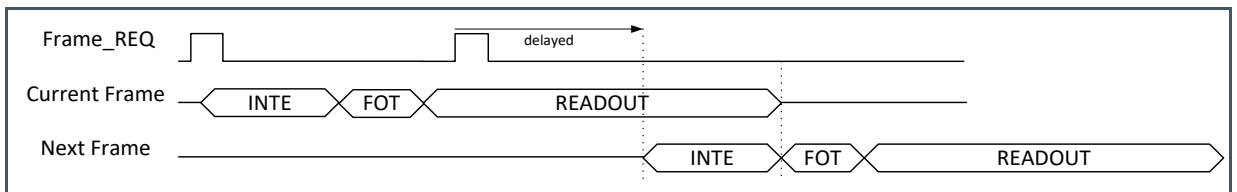

If a second frame request is given during the integration of the current frame, the sensor will remember this and delay the request as described above. This only works up to two Frame_REQ pulses during integration.

Figure 21:
Internal Exposure Delay 2

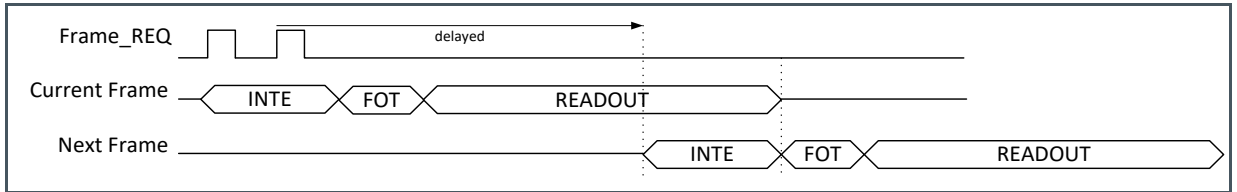

When keeping the Frame_REQ pin continuously high, the sensor will continuously read out frames at the maximum achievable frame rate.

Figure 22:
Internal Continuous Exposure

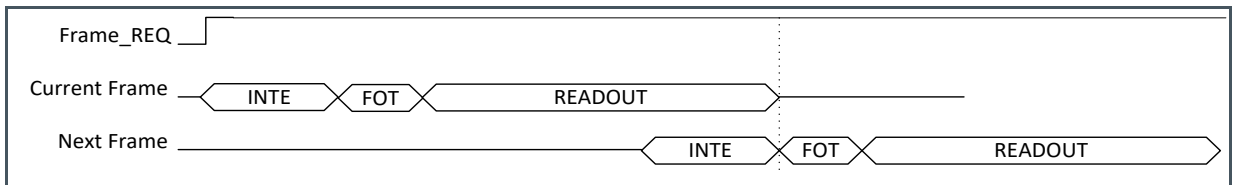

External Exposure Control

The exposure time can also be programmed externally by using the T_EXP1 (and T_EXP2) input pin. This mode needs to be enabled by setting the appropriate register (address 70[0]). In this case, the exposure starts when a high state is detected on the T_EXP1 pin. When a high value is detected on the FRAME_REQ input, the exposure time stops and the read-out will start automatically. A new exposure can start by sending a pulse to the T_EXP1 pin during or after the read-out of the previous frame.

Figure 23:
External Exposure Request for Two Frames

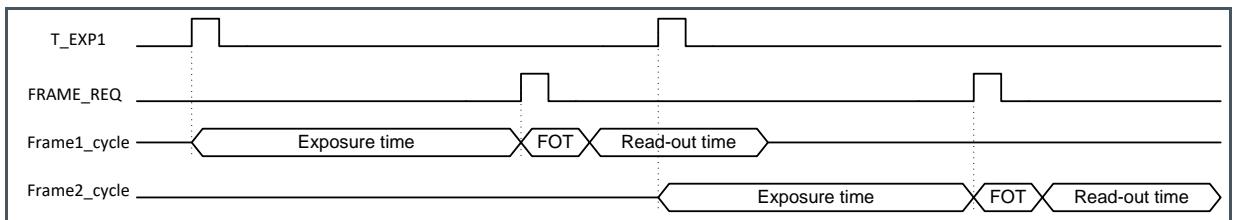

When the exposures stops too soon (by giving a Frame_REQ pulse during read-out), the current read-out will be finished normally and the exposure time will be extended so that the FOT starts immediately after the read-out.

Figure 24:
External Exposure Extension

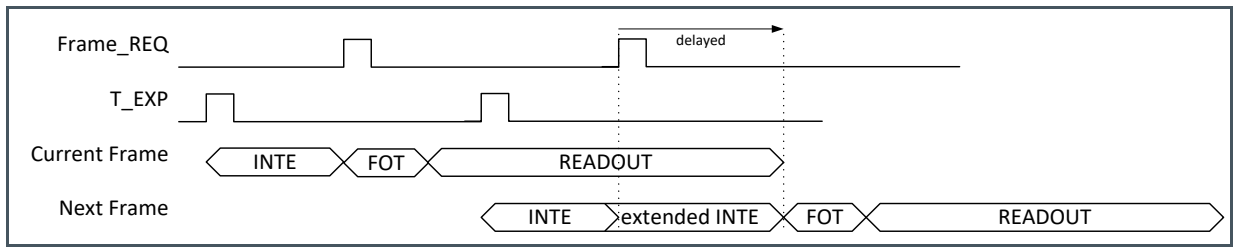

7.3 Sensor Readout Format

7.3.1 LVDS Outputs

The CMV12000 has LVDS (low voltage differential signaling) outputs to transport the image data to the surrounding system. Next to 64 data channels, the sensor also has two other LVDS channels for control and synchronization of the image data. In total, the sensor has 66 LVDS output pairs (2 pins for each LVDS channel):

- 64 data channels
- 1 control channel
- 1 clock channel

This means that a total of 132 pins of the CMV12000 are used for the LVDS outputs (128 for data + 2 for LVDS clock + 2 for control channel). See the pin list in Figure 4 for the exact pin numbers of the LVDS outputs.

The 64 data channels are used to transfer the 12-bit, 10-bit or 8-bit pixel data from the sensor to the receiver in the surrounding system. The 32 bottom channels use pins OUT1_N/P to OUT32_N/P and the top channels use pins OUT33_P/N to OUT64_P/N.

The output clock channel transports a clock, synchronous to the data on the other LVDS channels. This clock can be used at the receiving end to sample the data. This clock is DDR, which means that the frequency will be half of the output data rate. When 600 Mbit/s output data rate is used, the LVDS output clock will be 300 MHz (half of input clock).

The data on the control channel contains status information on the validity of the data on the data channels. Information on the control channel is grouped in 8-bit, 10-bit or 12-bit words that are transferred synchronous to the 64 data channels.

7.3.2 Low-Level Readout Format

The data is transferred LSB first, with the transfer of bit D[0] during the high phase of the DDR output clock. An example of 10b mode is shown below for the P-channel of one LVDS channel. T1 is the period of the input clock (600 MHz input clock = 300 MHz output clock).

Figure 25:
10b Pixel Data on an LVDS Channel

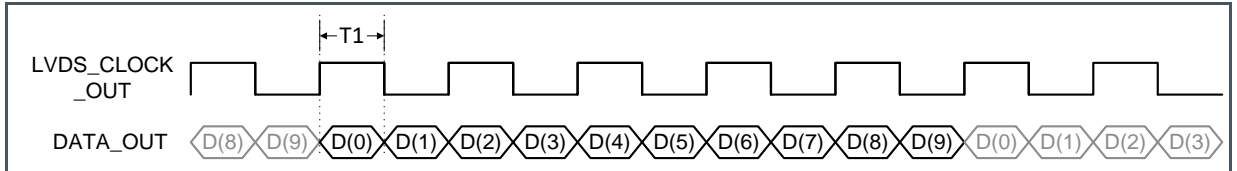

7.3.3 Pixel Readout Format

The read-out of image data is grouped in bursts of 128 pixels per channel (2 rows at the same time via top and bottom outputs). Each pixel is 8, 10 or 12 bits wide. For details on pixel remapping and pixel vs. channel location please see section 7.3.4. An overhead time exists between two bursts of 128 pixels. This overhead time has the length of one pixel read-out (i.e. the length of 8, 10 or 12 bits at the selected data rate).

Please note that depending on the bit mode (8-bit, 10-bit or 12-bit) and read-out mode (subsampling, binning...), the actual timing of the image data may differ from one mode to another. The sections below show the relative location of the pixel data only.

The sensor is designed to be used with both sides (bottom and top) simultaneously. There is a “one side mode” where only one side (bottom) can be used to read out data, but binning and subsampling in X and Y direction are not supported in this mode.

The sensor is able to send all pixel data over fewer channels. The overview of which outputs are used when multiplexing to fewer outputs is shown below.

Figure 26:
Channel Muxing Overview

	OUT 1	OUT 2	OUT 3	OUT 4	OUT 5	OUT 6	OUT 7	OUT 8	OUT 9	OUT 10	OUT 11	OUT 12	OUT 13	OUT 14	OUT 15	OUT 16	OUT 17	OUT 18	OUT 19	OUT 20	OUT 21	OUT 22	OUT 23	OUT 24	OUT 25	OUT 26	OUT 27	OUT 28	OUT 29	OUT 30	OUT 31	OUT 32
32	x	x	x	x	x	x	x	x	x	x	x	x	x	x	x	x	x	x	x	x	x	x	x	x	x	x	x	x	x	x	x	x
16	x		x		x		x		x		x		x		x		x		x		x		x		x		x		x		x	
8	x				x				x				x				x				x				x				x			
4	x								x								x															
2	x																x															
1	x																															
	OUT 33	OUT 34	OUT 35	OUT 36	OUT 37	OUT 38	OUT 39	OUT 40	OUT 41	OUT 42	OUT 43	OUT 44	OUT 45	OUT 46	OUT 47	OUT 48	OUT 49	OUT 50	OUT 51	OUT 52	OUT 53	OUT 54	OUT 55	OUT 56	OUT 57	OUT 58	OUT 59	OUT 60	OUT 61	OUT 62	OUT 63	OUT 64
32	x	x	x	x	x	x	x	x	x	x	x	x	x	x	x	x	x	x	x	x	x	x	x	x	x	x	x	x	x	x	x	x
16	x		x		x		x		x		x		x		x		x		x		x		x		x		x		x		x	
8	x				x				x				x				x				x				x				x			
4	x								x								x															
2	x																x															
1	x																															

By default, all 64 data output channels are used to transmit the image data. This means that two entire rows of image data are transferred (one using the top outputs and one using the bottom outputs) in one slot of 128 pixel periods ($64 \times 128 = 8192$). Next figure shows the timing for the top and bottom LVDS channels. The bottom channels read out the odd rows (start at 1) and the top channels read out the even rows.

Figure 27:
Data Output Timing with 64 (2x32) Channels

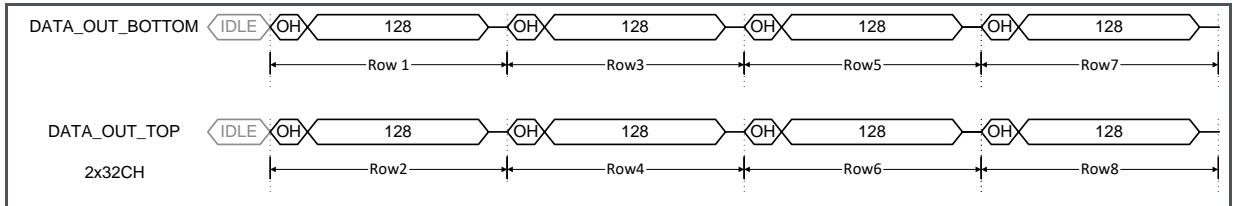

Only when 64 data outputs, running at 600 Mbit/s in 10b mode are used, the frame rate of 300 fps can be achieved.

Using less output channels, this can be programmed with register 81. In this multiplexed mode, the read-out of one row takes $N \times 128$ periods (but two rows will be sent out at the same time). $N = 1, 2, 3 \dots$ for 32, 16, 8 ... channels per side. Each block of 128 pixels (=DVAL) is separated by one OH, while each row of pixels (=LVAL) is separated by a longer OH (depending on the number of outputs and sides, subsampling and binning).

Next figure shows the timing when multiplexing to 16 channels on each side.

Figure 28:
Data Output Timing With 2x16 Channels

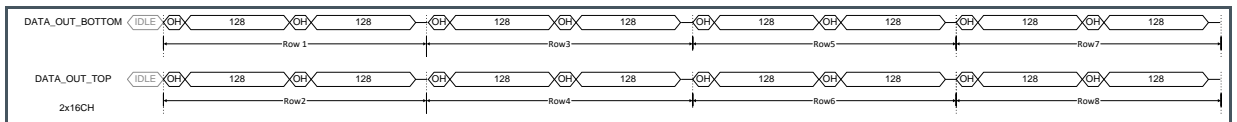

When using the 'one side mode', each row is readout by the bottom outputs following the pattern in the figure below.

Figure 29:
One Side Readout Mode With 32 (1x32) Channels

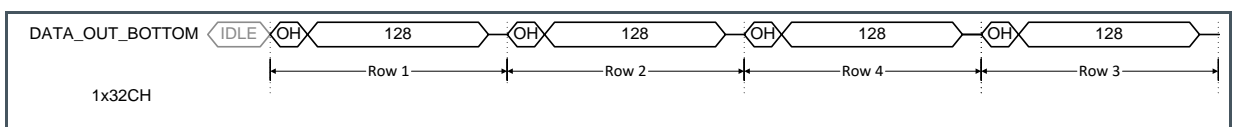

7.3.4 Pixel Remapping

Depending on the number of output channels, the pixels are located at different channels and are read out at a different moment in time. With the details from the next sections, the end user is able to remap the pixels on the outputs to their correct image array location.

Two Sided Readout Mode

Below are two examples of the pixel mapping when using 2 x 32 channels and 2 x 16 channels. It will be similar for less channels.

64 bursts (2 x 32) of 128 pixels happen in parallel on the data outputs. This means that two complete rows are read out in one burst; the odd rows via the bottom channels, the even rows via the top channels. The amount of rows that will be read out depends on the value in the corresponding register. By default there are 3072 rows read out.

Figure 30:
Pixel Mapping Using 2 x 32 Channels

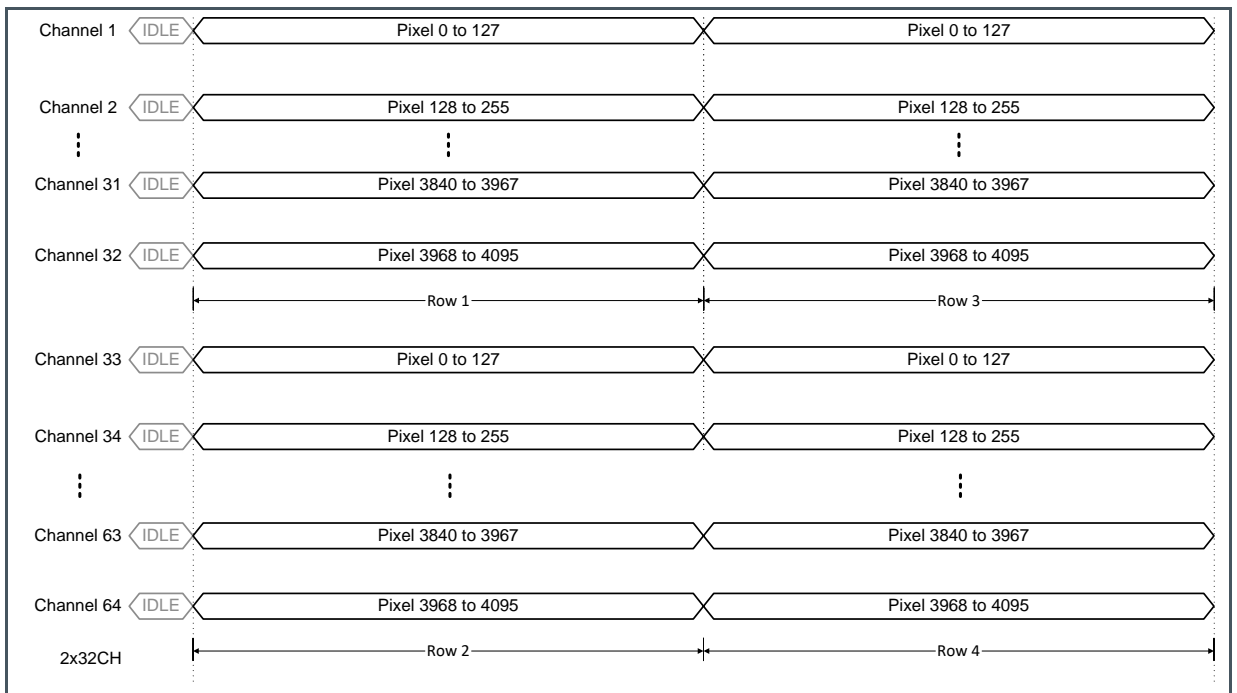

When 2 x 16 output mode is used, the pixel data is placed on the outputs as detailed in the figure below. 16 bursts of 128 pixels happen in parallel on the data outputs on both sides simultaneous (16 on the top and 16 on the bottom outputs); the odd rows via the bottom channels, the even rows via the top channels. This means that one complete row one each side is read out in two burst (so effectively two rows are read-out in two bursts).

The time needed to read out two rows is doubled compared to when 64 outputs are used. The even LVDS channels are not being used in this case, so they can be turned off by setting the correct bits in

the register with addresses 92-93. Turning off these channels will reduce the power consumption of the chip. The amount of rows that will be read out depends on the value in the corresponding register. By default there are 3072 rows being read out.

Figure 31:
Pixel Mapping Using 2 x 16 Channels

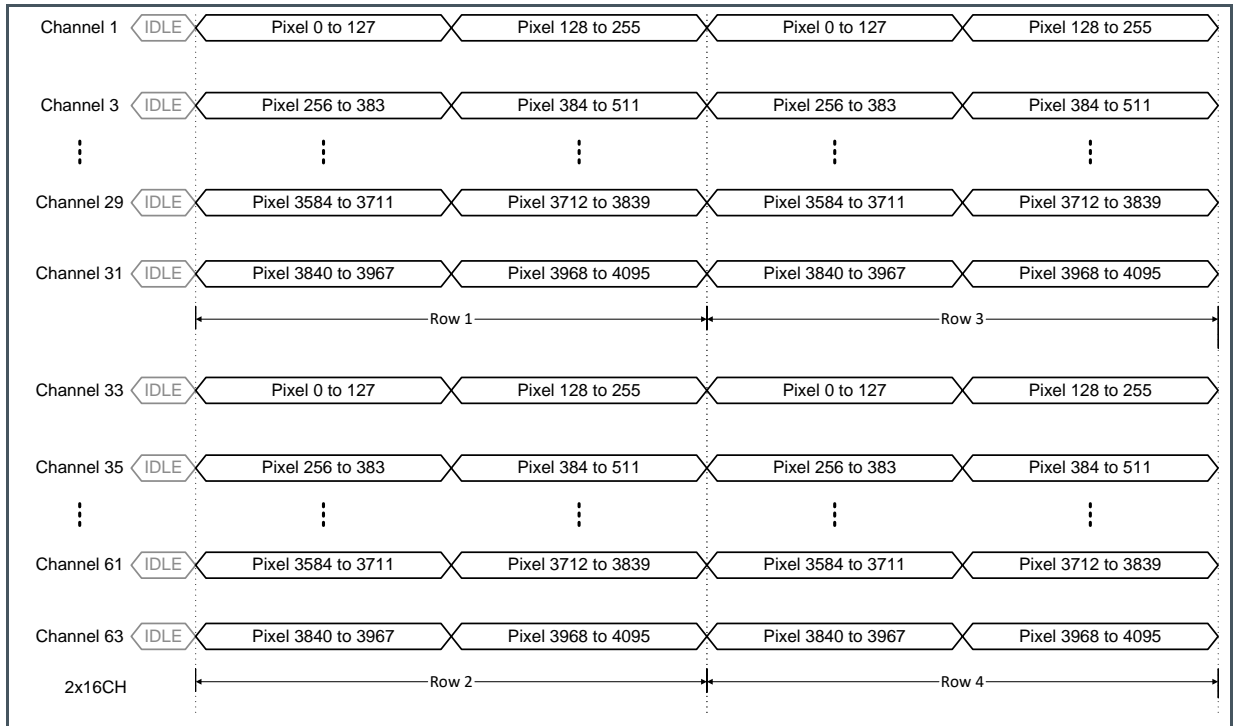

One Sided Readout Mode

When only one side is used, the pixel data is placed on the outputs as detailed in the figure below (example of 1 x 32 and 1 x 16). N bursts of 128 pixels happen in parallel on the data outputs. This means that one complete row is read out in one burst. The rows will be read out following the pattern: row 1, row 2, row 4, row 3, row 5, row 6, row 8, row 7... So every 3rd and 4th row are switched.

The time needed to read out two rows is doubled compared to when 64 outputs are used. The top LVDS channels are not being used in this mode, so they can be turned off by setting the correct bits in the register with addresses 92-93. Turning off these channels will reduce the power consumption of the chip. The amount of rows that will be read out depends on the value in the corresponding register. By default there are 3072 rows read out.

Figure 32:
Pixel Mapping Using 1 x 32 Channels

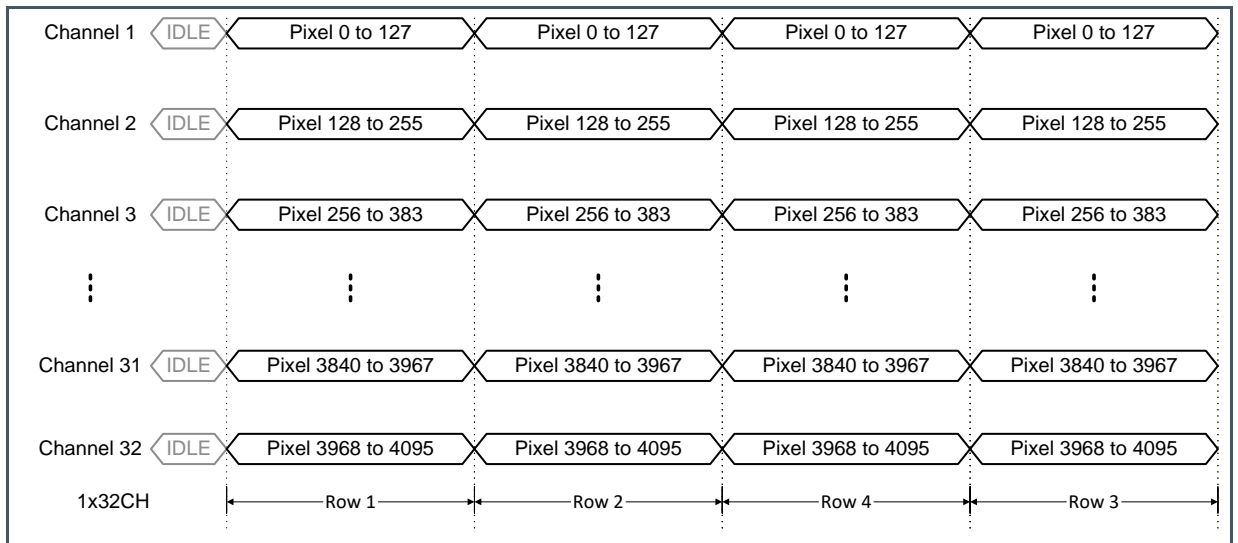
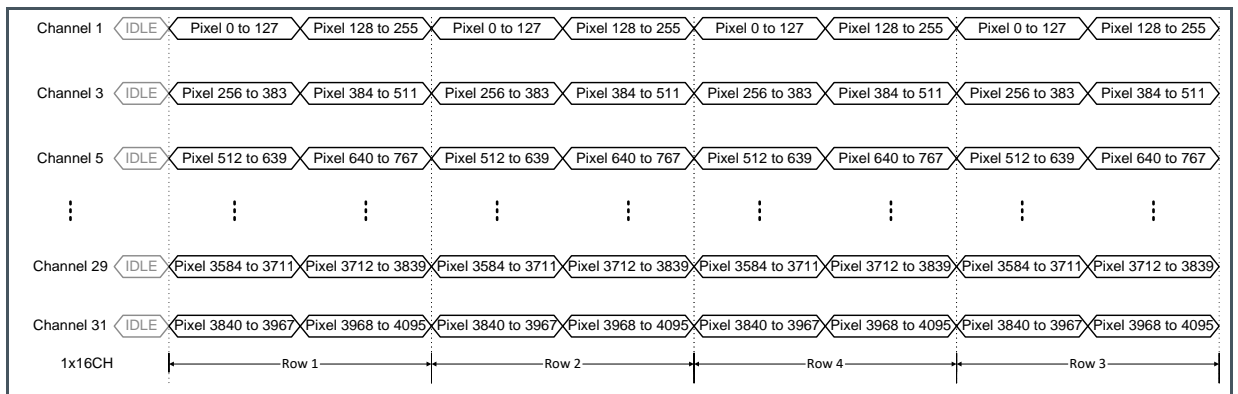

Figure 33:
Pixel Mapping Using 1 x 16 Channels



7.3.5 Control Channel

The CMV12000 has one LVDS output channel dedicated for the valid data synchronization and timing of the output channels. The end user must use this channel to know when valid image data or training data is available on the data output channels.

The control channel transfers status information in 8-bit, 10-bit or 12-bit word format. Every bit of the word has a specific function. Next table describes the function of the individual bits.

Figure 34:
Control Channel Status Bits

Bit	Function	Description
[0]	DVAL	Indicates valid pixel data on the outputs
[1]	LVAL	Indicates the validity of the read-out of a row
[2]	FVAL	Indicates the validity of the read-out of a frame
[3]	FOT	Indicates when the sensor is in FOT (sampling of image data in pixels) ⁽¹⁾
[4]	INTE1	Indicates when pixels of integration block 1 are integrating ⁽¹⁾
[5]	INTE2	Indicates when pixels of integration block 2 are integrating ⁽¹⁾
[6]	'0'	Constant zero
[7]	'1'	Constant one
[8]	'0'	Constant zero
[9]	'0'	Constant zero
[10]	'0'	Constant zero
[11]	'0'	Constant zero

(1) These status bits are purely functional and are not required to know if the pixel data is valid. DVAL, LVAL and FVAL is sufficient to know when to sample the image data.

The status bits of the control channel can be monitored on the TDIG1/2 pins (G26/G27) to see the state of the sensor. See section 7.6.6 for more details.

DVAL, LVAL and FVAL

The first three bits of the control word must be used to identify valid data and the read-out status. The next figure shows the timing of the DVAL, LVAL and FVAL bits of the control channel with an example of the read-out of a frame of four rows (default is 3072 rows). This example uses the default mode of 64 outputs (identical for one-side 32 outputs).

Figure 35:
xVAL Timing in 2 x 32 Channel Readout Mode

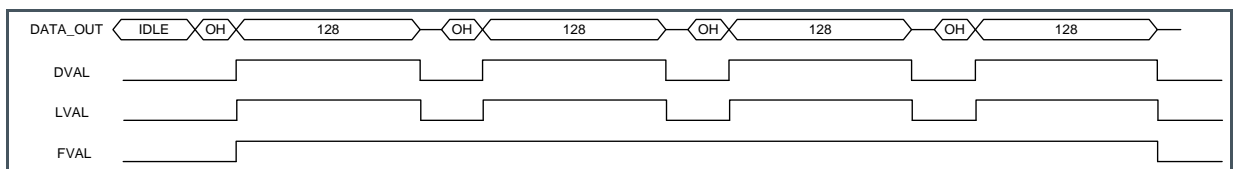

When only 16 outputs are used per side, the line read-out time is two times longer. The control channel considers this and the timing in this mode looks like the diagram below. The timing extrapolates identically for 8, 4, 2 and 1 output(s). Below is an example of a frame of two rows when only using 16 channels per side.

Figure 36:
xVAL Timing in 2 x 16 Channel Readout Mode

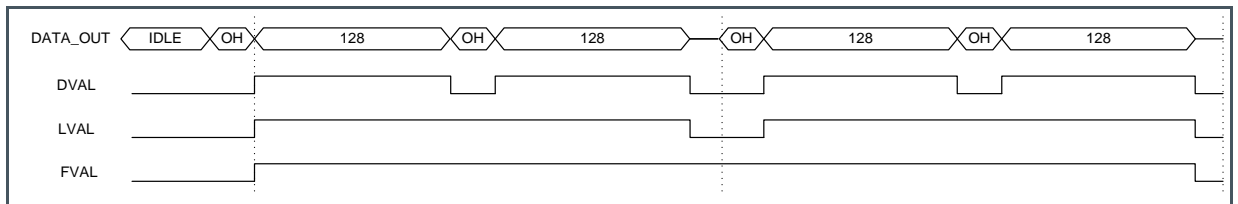

7.3.6 Training Data

To synchronize the receiving side with the LVDS outputs of the device, a known data pattern can be put on the output channels. This pattern can be used to “train” the LVDS receiver of the surrounding system to achieve correct bit and word alignment of the image data. Such a training pattern is set on all 64 data channel outputs when there is no valid image data to be sent (so, also in between bursts of 128 pixels). The training pattern is an 8-bit, 10-bit or 12-bit data word that replaces the pixel data. The sensor has a 12-bit sequencer register (address 89) that can be loaded via SPI to change the contents of the 12-bit training pattern TP1 for training during idle mode. TP2 equals TP1 with the 8 LSBs inverted and the 4 MSBs set to ‘0’ and can be used for word alignment during overhead time (OH). TP2 will be put on the data channels for one bit period and only before every LVAL. When there is more than one bit of idle time between two LVALs, TP1 will be set on the outputs for the remaining time. When DVAL is low but LVAL is high, only TP1 will be set on the data outputs.

The control channel does not send a training pattern, because it is used to send control information at all time. Word alignment can be done on this channel when the sensor is idle (not exposing or sending image data). In this case, all bits of the control word are zero, except for bit [7] (TPC).

The figure below shows the location of the training pattern on the data channels and control channel when the sensor is in idle mode and when a frame of two rows is read out. The mode of 16 outputs is selected.

Figure 37:
TP Timing

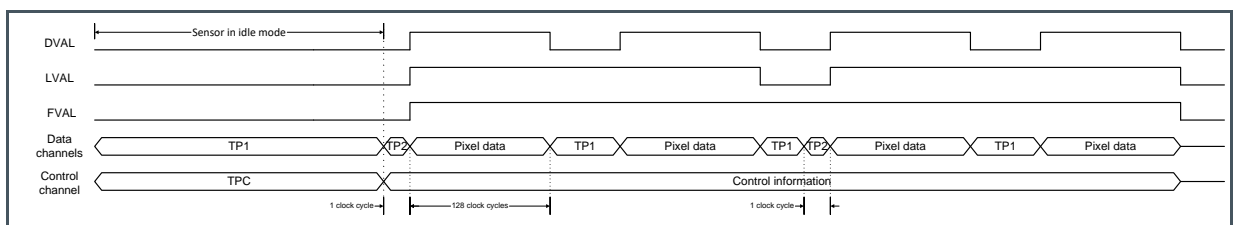

The typical output skew of the CMV12000 can be seen below. Per channel per side there is about a 150ps skew, which leads to a total skew of 4650ps between the first and last channels (OUT1 to OUT32 and OUT33 to OUT64). TP1 and TP2 can be used to correct for this during operation. The skew is independent of the clock speed, but shifts with temperature. Therefore realignment is needed

when (large) temperature changes occur. The skew can differ between devices; 150 ps is a typical value.

Figure 38:
Typical LVDS Output Skew

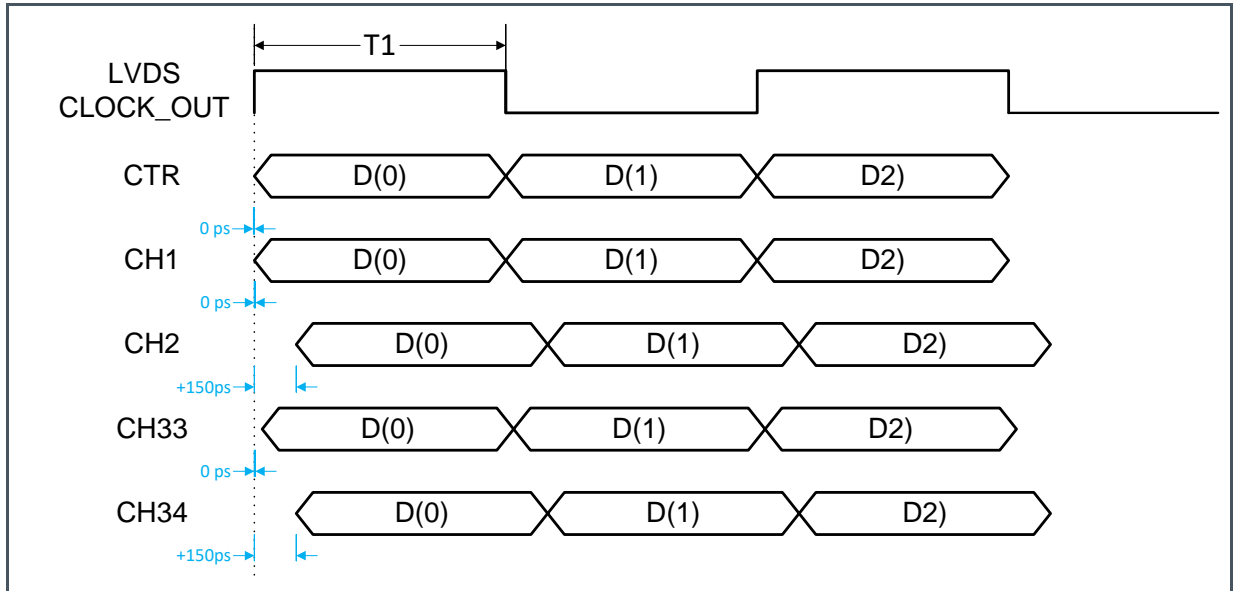

7.4 Configuring Exposure and Readout

This section explains how the CMV12000 can be programmed using the on-board sequencer registers.

7.4.1 Exposure Modes

The exposure time can be programmed in two ways, externally or internally. Externally, the exposure time is defined as the time between the rising edge of T_EXP1 and the rising edge of FRAME_REQ (see section 7.2.8 for more details). Internally, the exposure time is set by uploading the desired value to the corresponding sequencer register.

The table below gives an overview of the registers involved in the exposure mode.

Figure 39:
Exposure Modes

Reg. Name	Address	Bits	Default	Description
Exp_ext	70	[7:0]	0	0: Internal Exposure Mode. Exposure time is defined by register 71-72. 1: External Exposure Mode. Exposure time is defined by T_EXPx and FRAME_REQ triggers.

Reg. Name	Address	Bits	Default	Description
Exp_time	71 72	[15:0] [7:0]	1536	Sets the exposure time in Internal Exposure Mode using the formula below.

The formula to calculate the actual exposure time in internal exposure mode from the programmed registers is given by:

Equation 1:

$$Exposure\ time = ((Exp_{time} - 1) * (reg85 + 1) + (34 * reg82[7:0]) + 1) * LVDS_CLK_period * \#bits$$

The minimal exposure times when running at 600 MHz in internal mode will therefore be:

Figure 40:
Minimum Exposure Times in Internal Exposure Mode

Bit Mode	Min. Exposure Time [µs]
8	15.4
10	15.3
12	20.4

When using external exposure mode, the actual exposure time will be given by:

Equation 2:

$$Exposure\ time = time\ between\ T_EXP\ and\ FRAME_REQ + ((34 * reg82[7:0]) * LVDS_CLK_period * \#bits)$$

The time between the T_EXP and FRAME_REQ pulses will be clocked to a multiple of (LVDS_CLK_P/N_period * #bits).

For both modes there is an overlap of the exposure during the FOT (= the (34 * reg82[7:0]) part).

Figure 41:
Exposure FOT Overlap

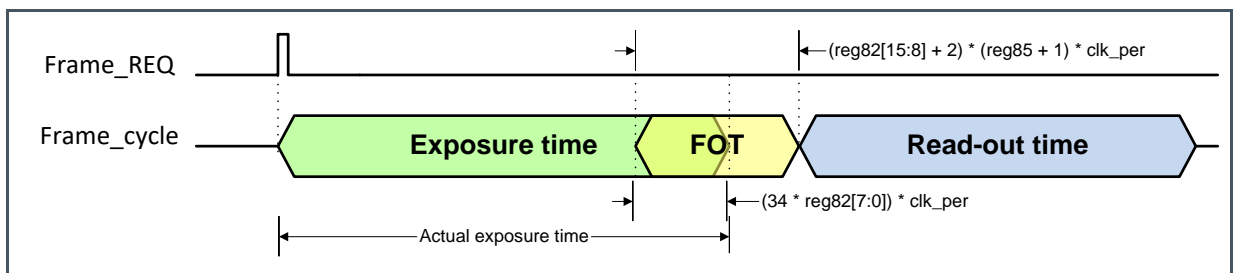

7.4.2 Frame Timing

The frame rate of the CMV12000 is defined by two main factors.

- Exposure time
- Read-out time

FOT (Frame Overhead Time) will only have an influence when very few rows are read out.

For ease of use we will assume that the exposure time is equal to or shorter than the read-out time. By assuming the frame rate is completely defined by the read-out time (because the exposure time happens in parallel with the read-out time). The read-out time (and thus the frame rate) is defined by:

- Clock speed: 600 MHz maximum
- ADC mode: 8, 10 or 12-bit
- Number of lines read-out (windowing, subsampling or binning)
- Number of LVDS data outputs used: 64 maximum

This means that if any of the parameters above are changed, it will have an impact on the frame rate of the sensor.

All timings can be expressed in line times:

Equation 3:

$$\text{Line time} = (\text{reg85} + 1) * \text{LVDS_CLK_period} * \text{\#bits}$$

The total read-out time is composed of the FOT and the image readout time. The image readout time is dependent of the total number of read out lines (*\#readout lines*), sides used and the line time.

Equation 4:

$$\text{FOT} = (\text{reg82}[15:8] + 2) * \text{Line time}$$

Equation 5:

$$\text{Readout time} = \frac{\text{\#readout lines}}{\text{\#sides}} * \text{Line time}$$

The number of lines read out will depend on the mode:

- Normal mode: *\#readout lines* = *Number_lines_tot*
- X&Y-Subsampling: *\#readout lines* = *Number_lines_tot/2*
- Binning: *\#readout lines* = *Number_lines_tot/4*

Number_lines_tot is the value of register 1.

When running at 600 MHz in 10-bit mode with 64 output channels, register 82[15:8] is 12 and register 85 is 128. This will result in a line time of 2.15 μs , FOT of 30.1 μs and an image read-out time of 3.3024 ms for the full pixel array.

The total frame time will be $3.3024 \text{ ms} + 0.0301 \text{ ms} = 3.3368 \text{ ms}$, which results in a frame rate of 300 fps.

If the exposure time is longer than the readout time the frame rate will depend on the exposure time.

Below you can see an overview of the frame rate in fps for a full resolution image and 64 outputs with a 600 MHz LVDS input clock.

Figure 42:
Frame Rates vs Modes

Bit Mode	Normal	X&Y-Subs.	Binning
8	333	401	251
10	300	533	267
12	132	267	267

As binning is done in the readout circuit, the four binned pixels have to be sampled, causing a longer readout time needed and a drop in frame rate. When using fewer outputs, the frame rate will improve when using binning.

Number of Frames

When using internal exposure mode, the number of frames taken at each frame request can be programmed. In external exposure mode, only one frame is taken each time or you can use continuous mode.

Figure 43:
Number of Frames Setting

Reg. Name	Address	Bits	Default	Description
Number_frames	80	[15:0]	1	1 to 65535

7.4.3 High Dynamic Range Modes

The sensor has different ways to achieve high optical dynamic range in the grabbed image.

- Interleaved read-out: the odd and even columns have a different exposure time
- Multiple slope: partial reset of the photodiode, within an exposure time, to reset the saturated pixels

All the HDR modes mentioned above can be used in both the internal and external exposure time modes.

Interleaved HDR

In this HDR mode, the odd and even columns of the image sensor will have a different exposure time. This mode can be enabled by setting the register in the table below.

Figure 44:
Interleaved HDR Settings

Reg. Name	Address	Bits	Default	Description
Exp_dual	70	[1]	0	0: HDR Off 1: HDR On

The surrounding system can combine the image of the odd columns with the image of the even columns, which can result in a high dynamic range image. In such an image, very bright and very dark objects are made visible without clipping. The table below gives an overview of the registers involved in the interleaved read-out when the internal exposure mode is selected.

Figure 45:
Interleaved HDR Exposure Settings

Reg. Name	Address	Bits	Default	Description
Exp_time	71	[15:0]	1536	Sets the exposure time for the even columns.
	72	[7:0]		
Exp_time2	73	[15:0]	1536	Sets the exposure time for the odd columns.
	74	[7:0]		

When the external exposure mode and interleaved read-out are selected, the different exposure times are achieved by using the T_EXP1 and T_EXP2 input pins. T_EXP1 defines the exposure time for the even columns, while T_EXP2 defines the exposure time for the odd columns. See the figure below for more details.

Figure 46:
Interleaved HDR With External Exposure

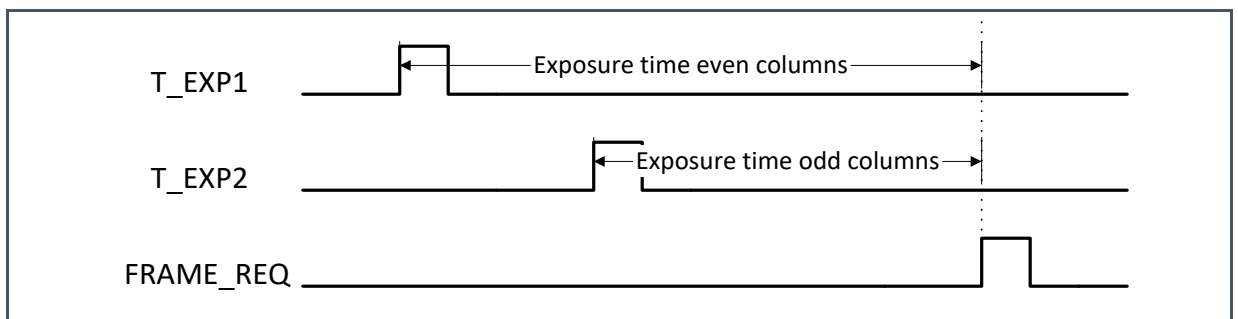

When a color sensor is used, the sequencer should be programmed to make sure it takes the bayer pattern into account when doing interleaved read-out. This can be done by setting the appropriate registers to '0'.

Figure 47:
Interleaved HDR Color Mode

Reg. Name	Address	Bits	Default	Description
Color	68	[0]	1	0: Color sensor 1: Monochrome sensor
Color_exp	68	[3]	1	0: Color sensor 1: Monochrome sensor

Multiple Slope HDR

The CMV12000 has the possibility to achieve a high optical dynamic range by using a multiple slope feature. This feature will partially reset those pixels, which reach a programmable voltage, while leaving the other pixels untouched. This can be done 2 times within one exposure time to achieve a maximum of three exposure slopes. See figure below for more details.

Figure 48:
Multiple Slope HDR

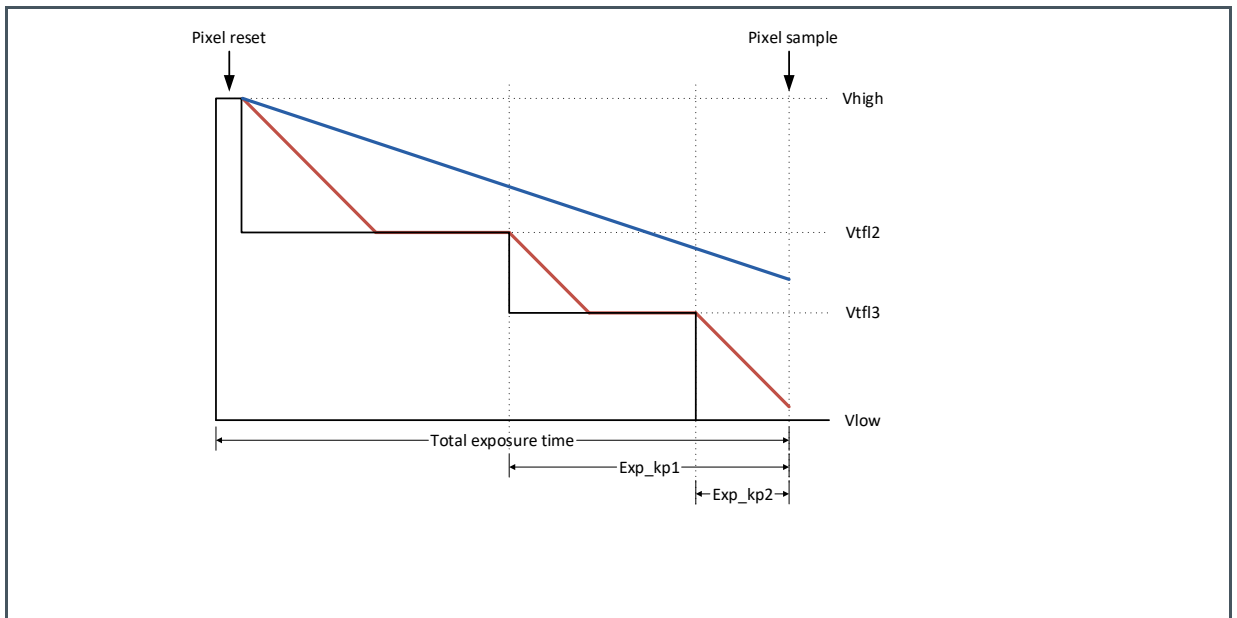

In the figure above, the red lines represent a pixel on which a large amount of light is falling. The blue line represents a pixel on which less light is falling. As shown in the figure, the bright pixel is held to a programmable voltage for a programmable time during the exposure time. This happens two times to make sure that at the end of the exposure time, the pixel is not saturated. The darker pixel is not

influenced by this multiple slope and will have a normal response. The Vtfl voltages and different exposure times are programmable using the sequencer registers. Using this feature, a response as detailed in the figure below can be achieved. The placement of the kneepoints in X is controlled by the Vtfl programming (64 = Vlow; 127 = Vhigh), while the slope of the segments is controlled by the programmed exposure times.

A good starting point is to set Exp_kp1 to 1% of the total exposure time and Exp_kp2 to 10% and setting Vtfl2 to 84 and Vtfl3 to 104.

Figure 49:
Multiple Slope HDR Kneepoints

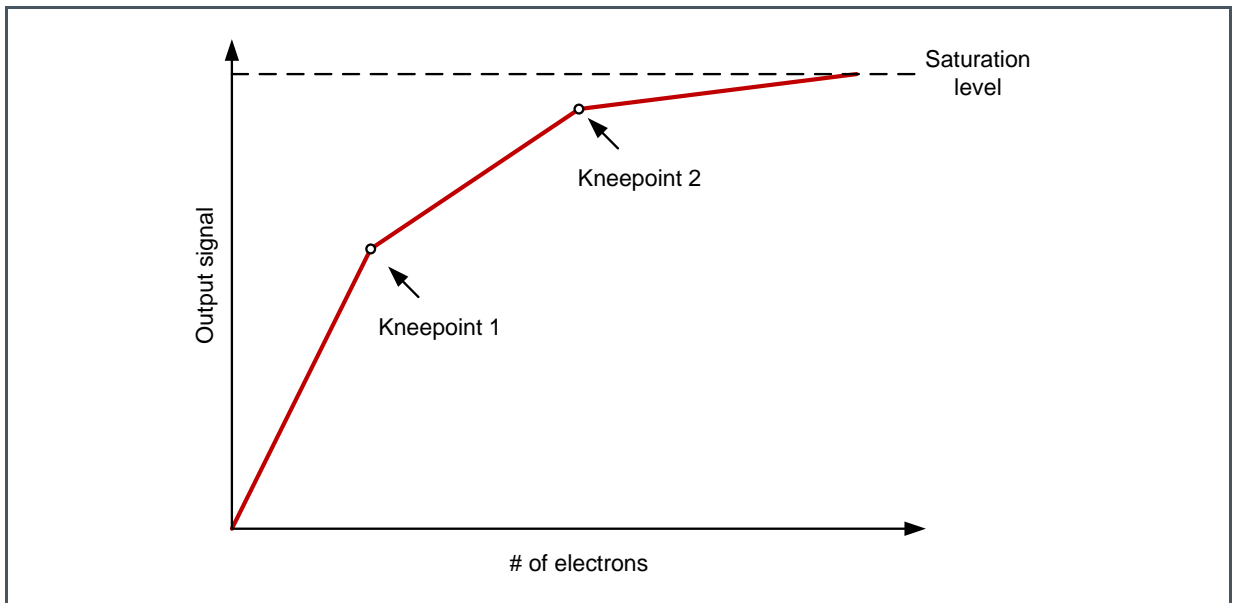

The following registers need to be programmed when multiple slopes in internal exposure mode are desired.

Figure 50:
Multiple Slope HDR Settings with Internal Exposure

Reg. Name	Address	Bits	Default	Description
Exp_time	71	[15:0]	1536	Sets the total exposure time
	72	[7:0]		
Number_slopes	79	[1:0]	1	Sets the number of slopes (min=1, max=3)
Exp_kp1	75	[15:0]	0	Sets the exposure time of kneepoint 1
	76	[7:0]		
Exp_kp2	77	[15:0]	0	Sets the exposure time of kneepoint 2
	78	[7:0]		
Vtfl2	106	106[6:0]	64	Sets the level of kneepoint 1: Bit [6] = 0/1: Enable/Disable DAC Bits [5:0]: Vtfl2 voltage level

Reg. Name	Address	Bits	Default	Description
Vtfl3	106	106[13:7]	64	Sets the level of kneepoint 2: Bit [13] =0/1: Enable/Disable DAC Bits [12:7]: Vtfl3 voltage level

With external exposure mode, the kneepoint and total exposure times are set with the T_EXP1/2 and FRAME_REQ triggers. The timing that needs to be applied in this external exposure mode looks like the one below.

Figure 51:
Multiple Slope HDR with External Exposure

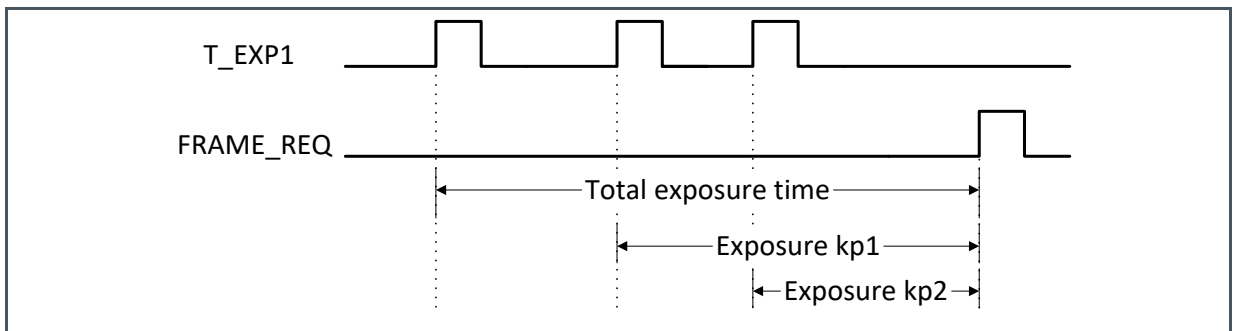

Attention

A combination of multiple slope and interleaved HDR is not supported.

7.4.4 Windowing

To limit the amount of data or to increase the frame rate of the sensor, windowing in Y direction is possible. The number of lines and start address can be set by programming the appropriate registers. The start address of a window should be a multiple of four (0, 4, 8 ...).

The size (number of rows) of a window has to be a certain multiple and this depends on the mode and number of sides used. These multiples are stated below:

Figure 52:
Window Size Multiples

Sides Used	Normal	XY-Subsampling	Binning
1	1	2	4
2	2	4	8

The CMV12000 has the possibility to read out multiple (max=32) predefined sub-windows in one read-out cycle. The default mode is to read out one window with the full frame size (4096x3072).

Single Window

When a single window is read out, the start address and size can be uploaded in the corresponding registers. The default start address is 0 and the default size is 3072 (full frame).

Figure 53:
Single Window Settings

Reg. Name	Address	Bits	Default	Description
Number_lines_tot	1	[15:0]	3072	Total number of lines read out from the sensor (1 to 3072).
Y_start_1	2	[15:0]	0	Row start address of the window (0 to 3071).

Figure 54:
Single Window

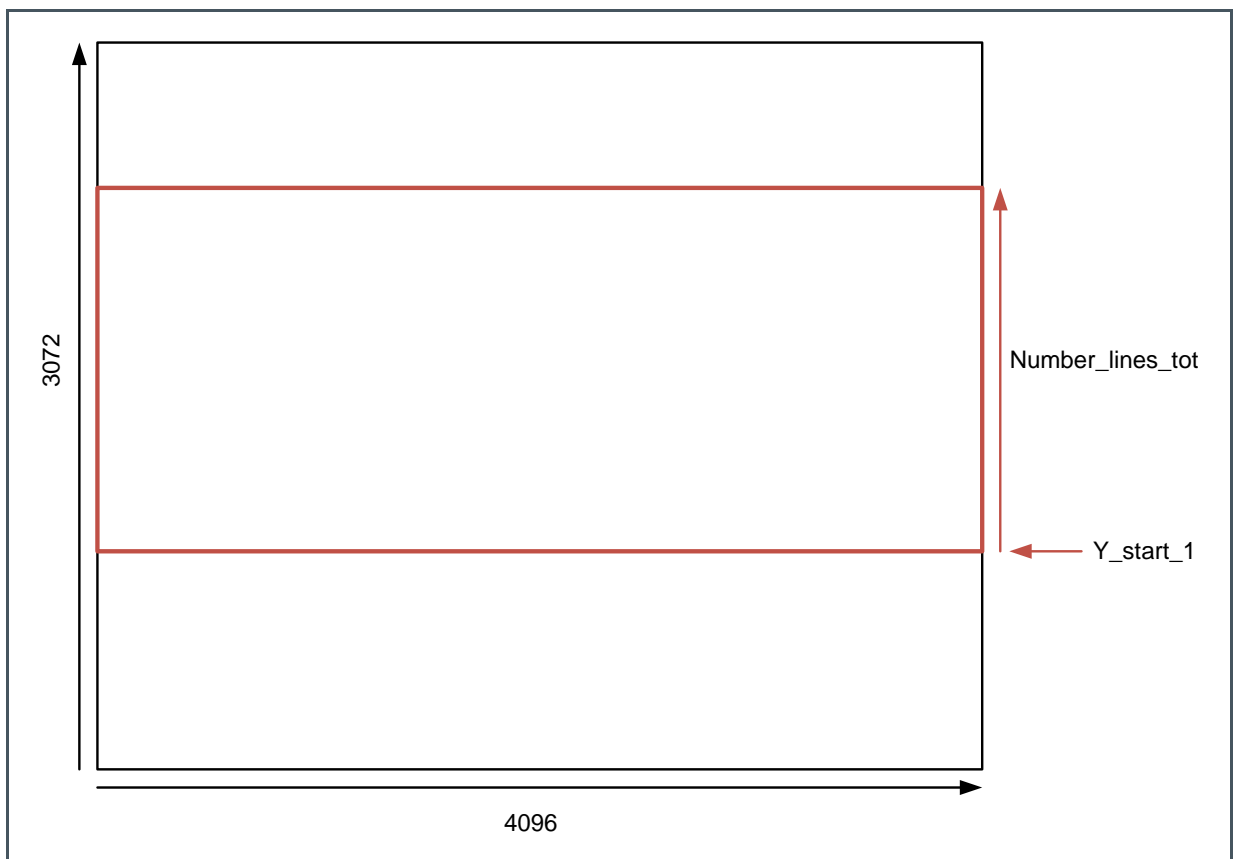

Multiple Windows

The CMV12000 can read out a maximum of 32 different sub-windows in one read-out cycle. The location and length of these sub-windows must be programmed in the correct registers. The location of multiple windows can be random but the windows should not overlap. The total number of lines to be read out (sum of all windows) needs to be specified in the Number_lines_tot register. The registers, which need to be programmed for the multiple windows, can be found in the table below.

Figure 55:
Multiple Window Settings

Reg. Name	Address	Bits	Default	Description
Number_lines_tot	1	[15:0]	3072	Total number of lines read out from the sensor (1 to 3072).
Y_start_1	2			
Y_start_2	3	[15:0]	0	Row start address of the window (0 to 3071).
...	...			
Y_start_32	33			
Y_size_1	34			
Y_size_2	33	[15:0]	0	Number of read out lines in the window (1 to 3072).
...	...			
Y_size_31	65			

The default values will result in readout of one window with 3072 lines starting at row 0.

Figure 56:
Multiple Windows

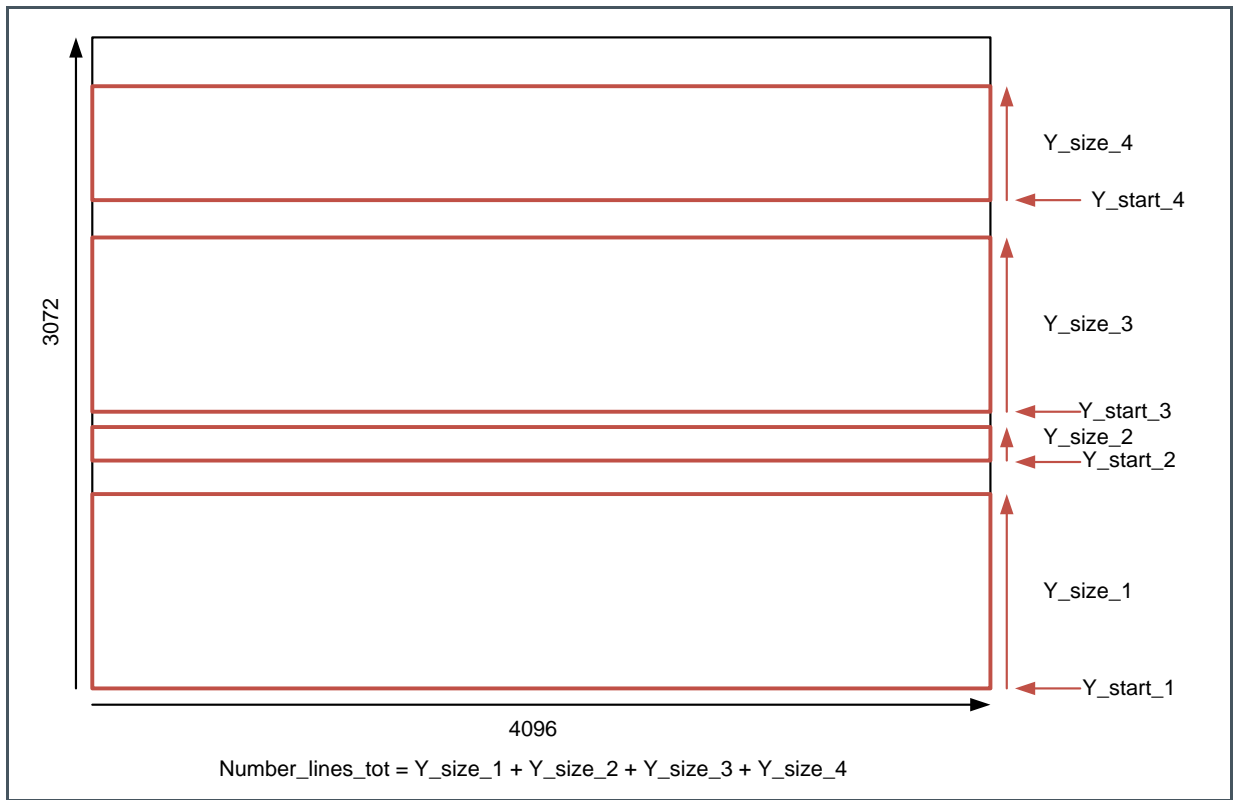

7.4.5 Mirroring

The image coming out of the image sensor, can be flipped in Y direction. When flipping in Y is enable, the bottom left pixel (0, 3071) is read out first instead of the top left one (0, 0). The following registers are involved in image flipping.

Figure 57:
Mirroring Settings

Reg. Name	Address	Bits	Default	Description
Image_flipping	69	[1:0]	0	0: No mirroring 2: Mirror in Y

7.4.6 Subsampling

This mode is only supported in two sided readout. To maintain the same field of view but reduce the amount of data coming out of the sensor, a subsampling mode is implemented on the chip. Different subsampling schemes can be programmed by setting the appropriate registers. These subsampling

schemes can take into account whether a color or monochrome sensor is used to preserve the Bayer pattern information. The registers involved in subsampling are detailed below. A distinction is made between a monochrome and color mode and subsampling in Y (skip rows) and X and Y (skip columns and rows). Subsampling can be enabled in every windowing mode.

Depending on the subsampling and color mode different subsampling schemes are possible.

Figure 58:
Subsampling Schemes

Color Mode	Y-Subsampling	X&Y-Subsampling
Monochrome	Read out 1 row, skip 1,5,9... rows	Read out 1 column and row, skip 1 column and row
Color	Read out 2 rows, skip 2, 6, 10 ... rows	Read out 2 column and row, skip 2 column and rows

Y-Subsampling

Below you can find an overview of the settings used for monochrome and color devices together with some examples for Y-subsampling.

Figure 59:
Y-Subsampling Settings for Monochrome

Reg. Name	Address	Bits	Default	Description
Number_lines_tot	1	[15:0]	3072	Total number of lines read out from the sensor (1 to 1536)
Sub_offset	66	[15:0]	0	Value = (number_of_lines_to_skip +1) /2
Sub_step	67	[15:0]	1	Value = (number_of_lines_to_skip +1)
Sub_en	68	[1]	0	Set to 0
Color	68	[0]	1	Set to 1
Color_exp	68	[3]	1	Set to 1

Figure 60 :
Y-Subsampling for Monochrome Examples (skip 5 and skip 1)

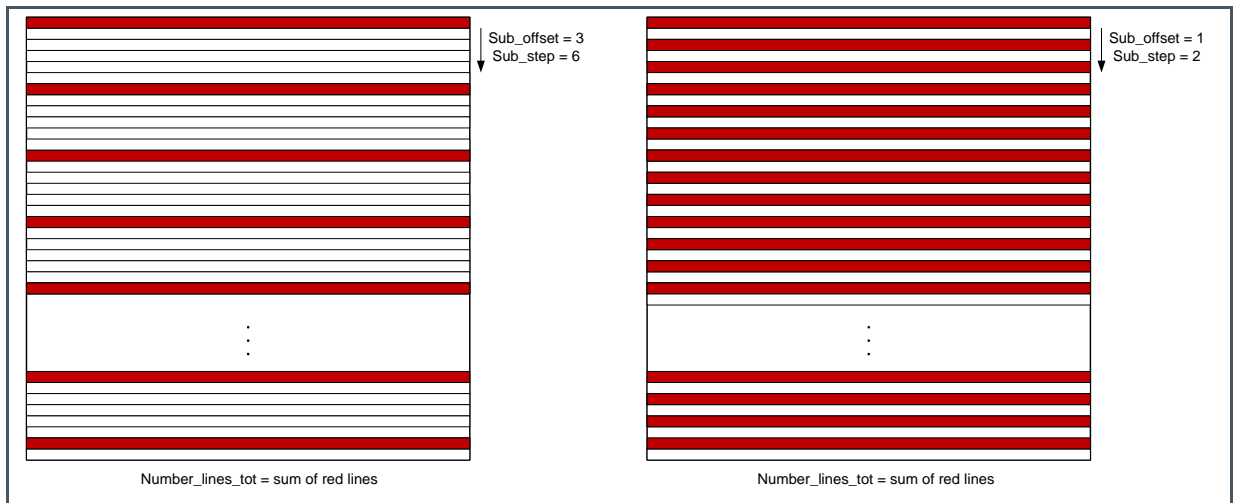
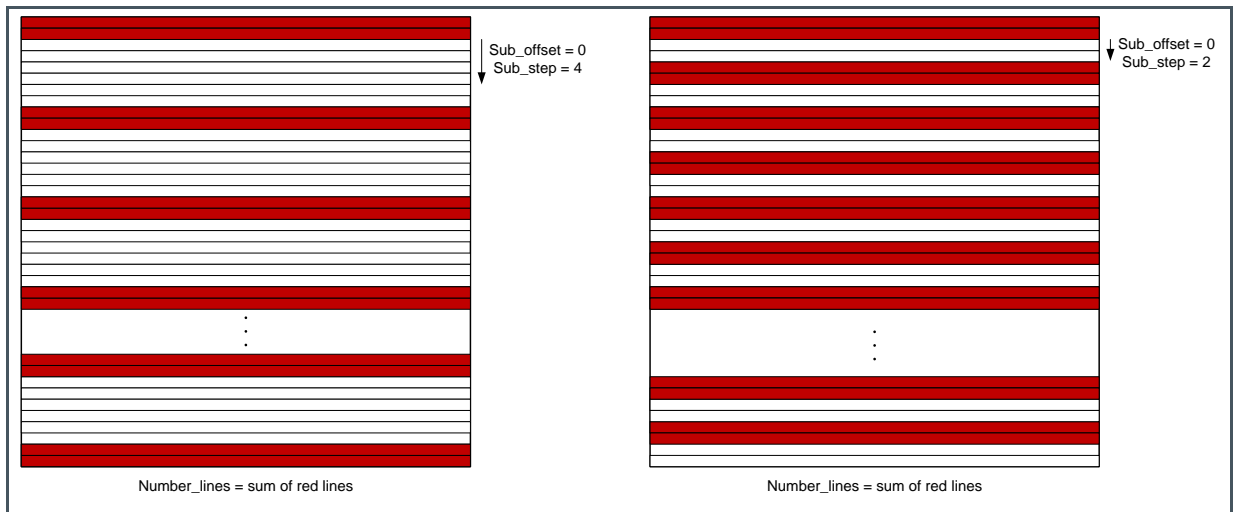

Figure 61:
Y-Subsampling Settings for Color

Reg. Name	Address	Bits	Default	Description
Number_lines_tot	1	[15:0]	3072	Total number of lines read out from the sensor (1 to 1536)
Sub_offset	66	[15:0]	0	Set to 0
Sub_step	67	[15:0]	1	Value = (number_of_lines_to_skip/2) + 1
Sub_en	68	[1]	0	Set to 0
Color	68	[0]	1	Set to 0
Color_exp	68	[3]	1	Set to 0

Figure 62:
Y-Subsampling for Color Examples (skip 6 and skip 2)



X&Y-Subsampling

With subsampling in both X and Y, the sensor skips both rows and columns. There are only 2 schemes possible in this mode: read 1 row/column, skip 1 row/column (monochrome) and read 2 rows/columns, skip 2 rows/columns (color). Below you can find an overview of the settings used for monochrome and color devices together with some examples for X&Y-subsampling.

Figure 63:
X&Y-Subsampling Settings for Monochrome

Reg. Name	Address	Bits	Default	Description
Number_lines_tot	1	[15:0]	3072	Total number of lines read out from the sensor (1 to 1536)
Sub_offset	66	[15:0]	0	Set to 1
Sub_step	67	[15:0]	1	Set to 2
Sub_en	68	[1]	0	Set to 1
Color	68	[0]	1	Set to 1
Color_exp	68	[3]	1	Set to 1

Figure 64:
Y-Subsampling for Monochrome Example

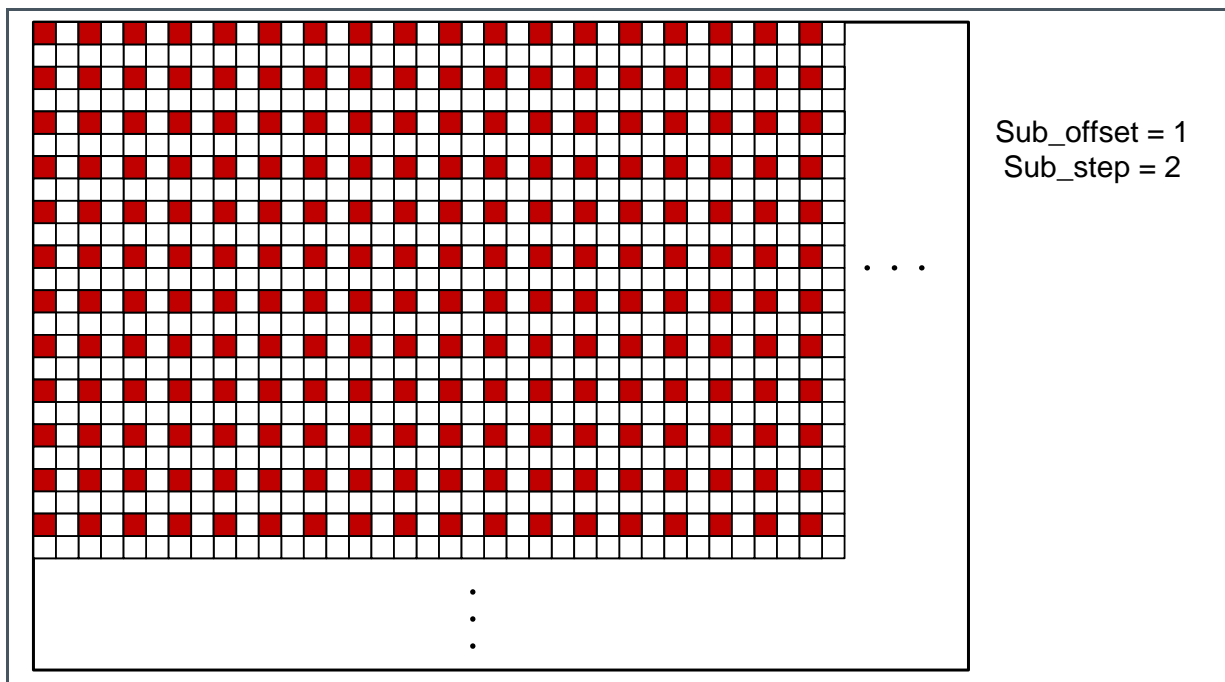
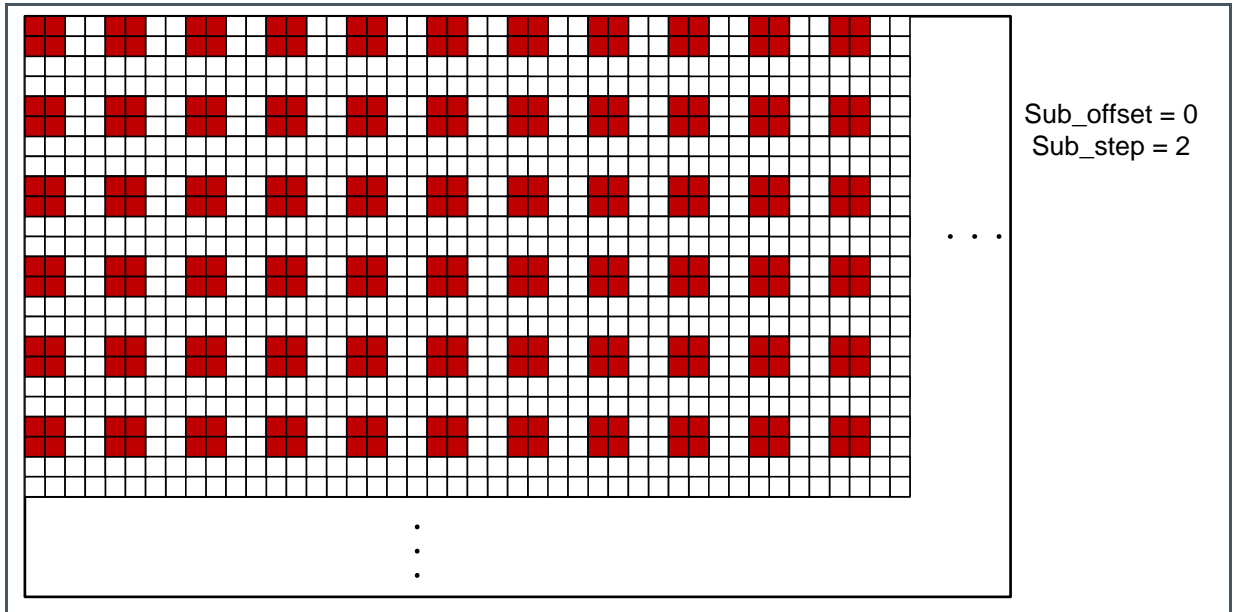

Figure 65:
X&Y-Subsampling Settings for Color

Reg. Name	Address	Bits	Default	Description
Number_lines_tot	1	[15:0]	3072	Total number of lines read out from the sensor (1 to 1536)
Sub_offset	66	[15:0]	0	Set to 0
Sub_step	67	[15:0]	1	Set to 2
Sub_en	68	[1]	0	Set to 1
Color	68	[0]	1	Set to 0
Color_exp	68	[3]	1	Set to 0

Figure 66:
Y-Subsampling for Color Example



Pixel Remapping

When enabling subsampling, the pixel mapping on the outputs will differ from the default mapping.

When Y-subsampling is enabled, the pixel remapping of the subsampled image using 64 outputs can be found in the figure below. The rows mentioned below are the readout rows, not the physical rows.

Figure 67:
Pixel Remapping for Y-Subsampling

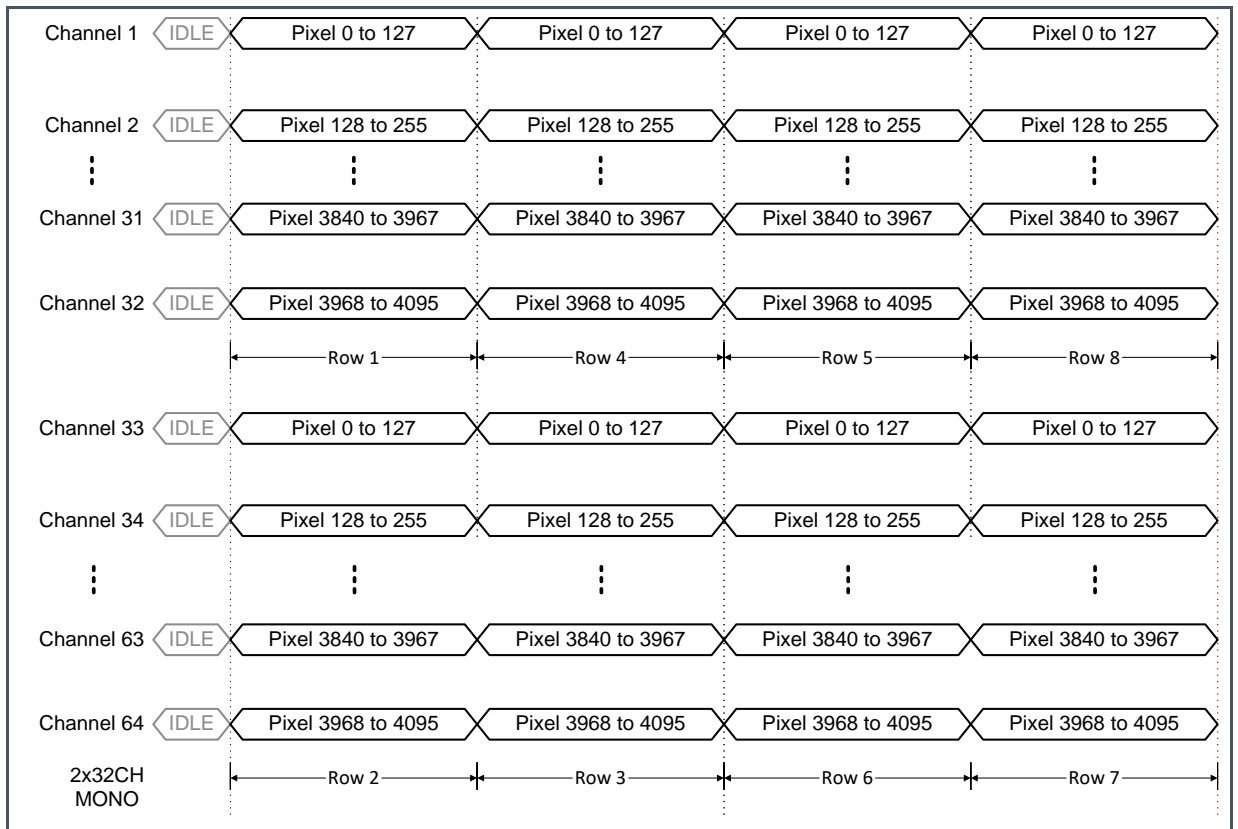

So the bottom channels will read out rows 1, 4, 5, 8, 9, 12 ... and the top channels will read out rows 2, 3, 6, 7, 10, 11 ... 64 bursts (2 x 32) of 128 (2 x 64) pixels happen in parallel on the data outputs. This means that two complete subsampled rows are read out in one burst. The amount of rows that will be read out depends on the value in the corresponding register. By default there are 1536 rows being read out (3072/2).

When X&Y-subsampling is enabled, the pixel remapping is different for monochrome and color devices. An example of the subsampled image using 64 outputs can be found in the figures below.

Figure 68:
Pixel Remapping for Monochrome X&Y-Subsampling

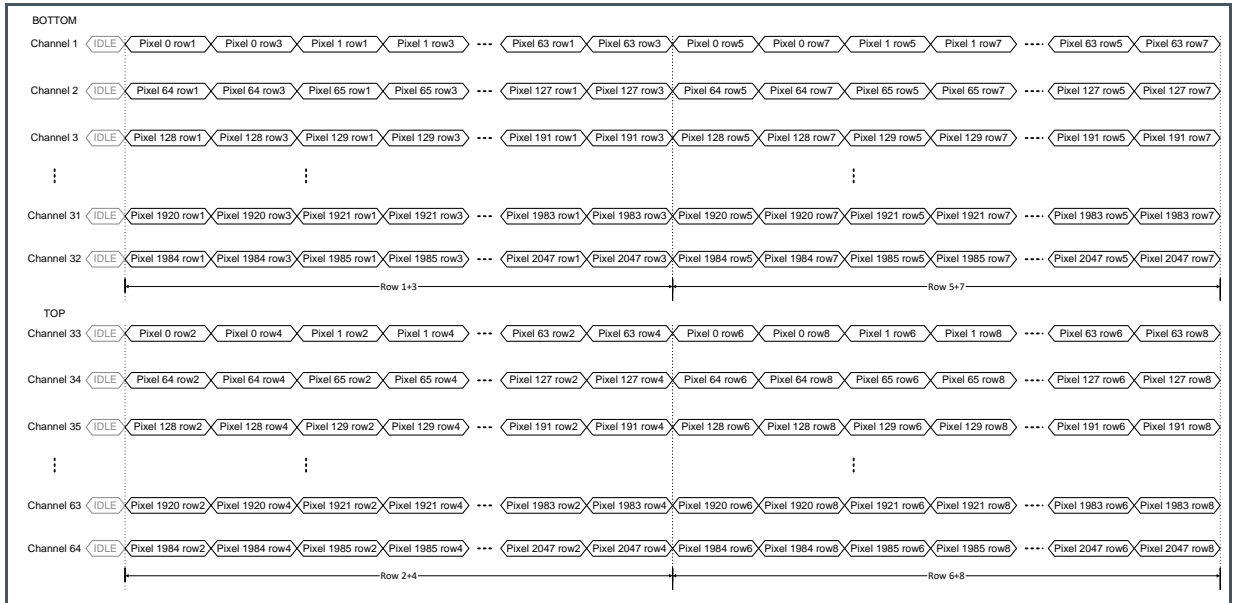

Figure 69:
Pixel Remapping for Color X&Y-Subsampling



64 bursts (2 x 32) of 128 (2 x 64) pixels happen in parallel on the data outputs. This means that four complete subsampled rows are read out in one burst. The amount of rows that will be read out depends on the value in the corresponding register. By default there are 1536 rows being read out (3072/2).

7.4.7 Binning

This mode is only supported in two sided read-out. To maintain the same field of view but reduce the noise coming out of the sensor, a binning mode is implemented on the chip. This mode will sum four pixels (in the analog domain) to reduce the noise and data coming from the chip. This increases the responsivity with x4. The PGA divide-by-3 can be used to reduce this. Other PGA gains are not possible (x2, x3, x4). Different binning schemes can be programmed by setting the appropriate registers. These binning schemes can take into account whether a color or monochrome sensor is used to preserve the Bayer pattern information. The registers involved in binning are detailed below. A distinction is made between a monochrome and color mode. Binning can be enabled in every windowing mode.

When monochrome binning is used, the CMV12000 will average four pixels and reads out this average pixel value. This will result in an image, which is four times smaller than the original image (X-size/2 and Y-size/2, max 2048 x 1536).

To enable this monochrome binning, the following registers need to be changed.

Figure 70:
Binning Settings for Monochrome

Reg. Name	Address	Bits	Default	Description
Number_lines_tot	1	[15:0]	3072	Total number of lines of the original (pre-binning) image (1 to 3072)
Sub_offset	66	[15:0]	0	Set to 0
Sub_step	67	[15:0]	1	Set to 1
Bin_en	68	[2]	0	Set to 1
Color	68	[0]	1	Set to 1
Color_exp	68	[3]	1	Set to 1

Figure 71:
Binning for Monochrome Example

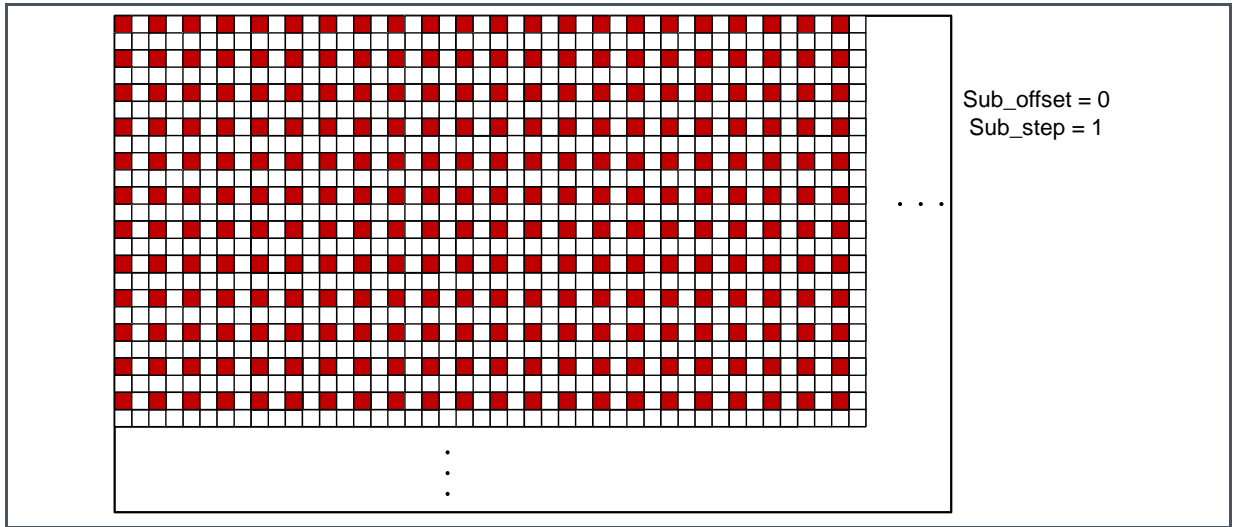
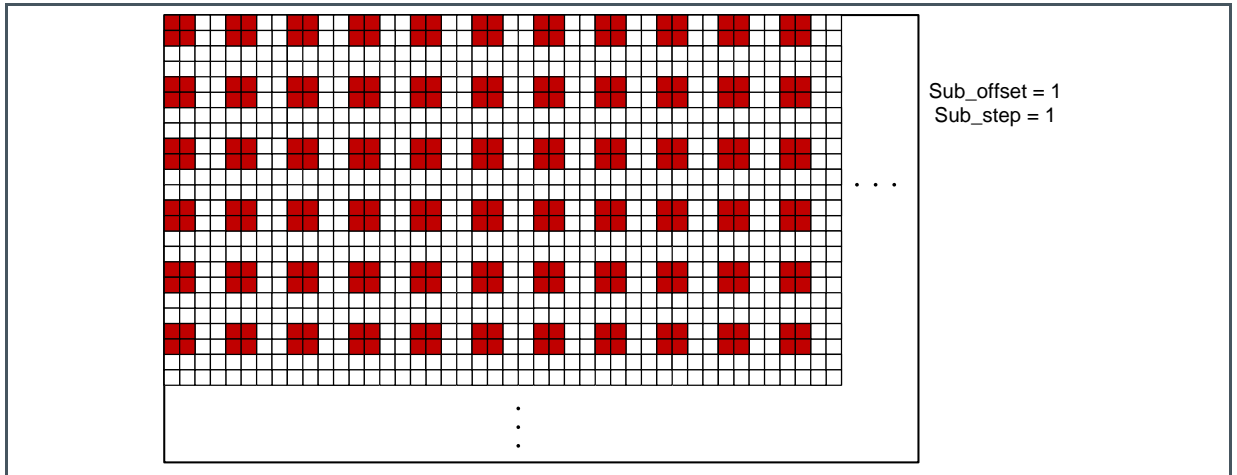

Figure 72:
Binning Settings for Color

Reg. Name	Address	Bits	Default	Description
Number_lines_tot	1	[15:0]	3072	Total number of lines of the original (pre-binning) image (1 to 3072)
Sub_offset	66	[15:0]	0	Set to 1
Sub_step	67	[15:0]	1	Set to 1
Bin_en	68	[2]	0	Set to 1
Color	68	[0]	1	Set to 0
Color_exp	68	[3]	1	Set to 0

Figure 73:
Binning for Color Example



Pixel Remapping

When enabling binning, the pixel mapping on the outputs will differ from the default mapping.

Figure 74:
Pixel Remapping for Monochrome Binning



Figure 75:
Pixel Remapping for Color Binning

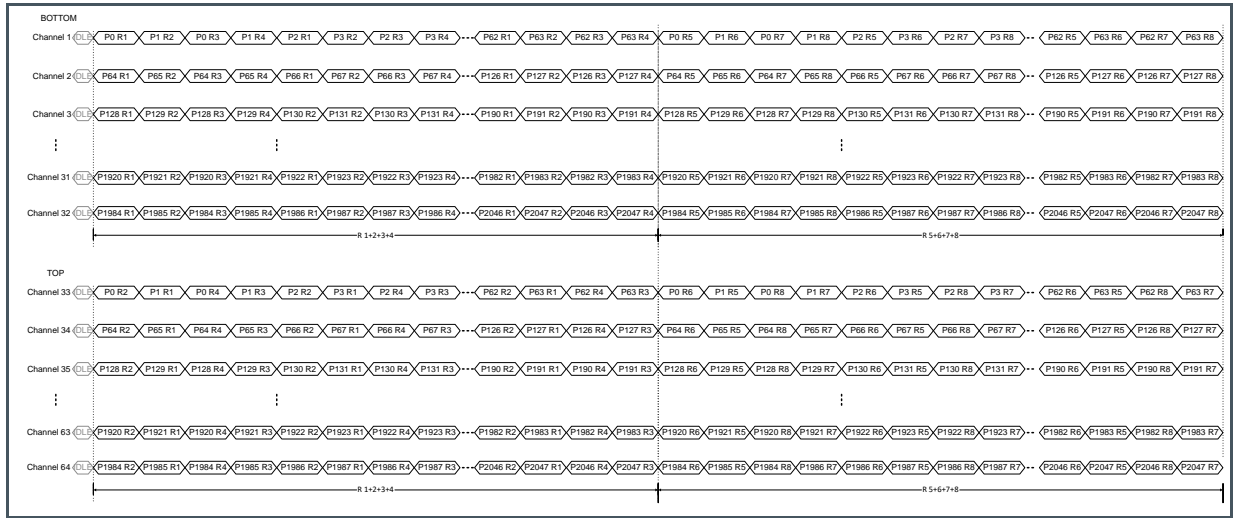

7.5 Configuring Output Data Format

7.5.1 Output Mode

The number of LVDS channels on each side can be selected by programming the appropriate sequencer register. The pixel remapping scheme and the read-out timing for each mode can be found in section 0 of this document. See section 5.15 for additional required register settings. The bottom channels use output pins OUT1_N/P to OUT32_N/P and the top channels use output pins OUT33_N/P to OUT64_N/P.

Figure 76:
Output Mode

Reg. Name	Address	Bits	Default	Description
Output_mode	81	[4:0]	0	0: 32 outputs used on each side 1: 16 outputs used on each side 3: 8 outputs used on each side 7: 4 outputs used on each side 15: 2 outputs used on each side 31: 1 output used on each side
Disable_top	81	[5]	0	0: Two side readout 1: One side readout (bottom channels only)
Sub_offset	66	[15:0]	0	Set to 65535 when Disable_top = 1 and no subsampling in Y is used.



Attention

Subsampling and binning are not supported when only using one side readout

7.5.2 Training Pattern

As detailed in section 7.3.6, a training pattern is sent over the LVDS data channels whenever no valid image data is sent. The training pattern TP1 can be programmed using the sequencer register below.

Figure 77:
Training Pattern

Reg. Name	Address	Bits	Default	Description
Training_pattern	89	[11:0]	85	Sets the training pattern value.

7.5.3 Bit Mode

The CMV12000 has the possibility to send 12 bits, 10 bits or 8 bits per pixel. The end user can select the desired resolution by programming the corresponding sequencer register. See section 3.8 for details on how the bit mode can be changed. See section 5.17 for additional required register settings.

Figure 78:
Bit Mode Setting

Reg. Name	Address	Bits	Default	Description
Bit_mode	118	[1:0]	1	0: 12b (12 bits per pixel) 1: 10b (10 bits per pixel) 2: 8b (8 bits per pixel)

When changing the bit mode of the ADC, the ADC input range also has to be modified so the analog pixel voltage is in the correct range of the ADC input.

Figure 79:
ADC Range Settings

Reg. Name	Address	Bits	Default	Description
ADC_range	116	[7:0]	127	Change the slope and the input range of the ramp used by the ADC 205: 8b 165: 10b 230: 12b

Reg. Name	Address	Bits	Default	Description
ADC_range_mult	116	[9:8]	1	Change multiplier of the slope and the input range of the ramp used by the ADC 0: 8b (x1) 1: 10b (x2) 3: 12b (x4)
ADC_range_mult2	100	[1:0]	0	Change multiplier of the slope and the input range of the ramp used by the ADC for lower clock speeds. Only use with ADC_range_mult=3. 0: x4 1: x8 3: x16

The ADC range also has to be adjusted when using different clock speeds. See section 7.7.4.

7.5.4 Data Rate

During start-up or after a sequencer reset, the data rate can be changed if a lower speed than 600 Mbit/s is desired. This can be done by applying a lower LVDS input clock (LVDS_CLK_P/N).

7.5.5 Power Consumption

The power consumption of the sensor can be decreased by disabling the LVDS data channels when they are not used (in 32, 16, 8, 4, 2 or 1 channel(s) mode). Disabling an output saves about 15mW on the VDD18 supply per output.

Figure 80:
Power Consumption

Reg. Name	Address	Bits	Default	Description
Channel_en_bot	90	[15:0]	65535	Sets 1 channel per bit for the bottom outputs
	91	[15:0]		0: Disabled 1: Enabled
Channel_en_top	92	[15:0]	65535	Sets 1 channel per bit for the top outputs
	93	[15:0]		0: Disabled 1: Enabled
Channel_en	94	[2:0]	7	Bit 0: Output clock channel Bit 1: Control channel Bit 2: Input clock channel 0: Disabled 1: Enabled

7.6 Additional Features

7.6.1 Offset

A digital offset can be applied to the output signal. This dark level offset can be programmed by setting the desired value in the sequencer registers. A bottom and top channel offset can be given to the dark level by programming the appropriate registers. This offset should be adjusted per device and per bit mode to get the desired dark level.

Figure 81:
Offset Settings

Reg. Name	Address	Bits	Default	Description
Offset_bot	87	[11:0]	780	Sets the relative offset of the dark level for the bottom outputs following a 2's-complement code. 1815: 12b 510: 10b 520: 8b
Offset_top	88	[11:0]	780	Sets the relative offset of the dark level for the top outputs following a 2's-complement code. 1815: 12b 510: 10b 520: 8b

7.6.2 Gain

An analog (using a Programmable Gain Amplifier) and digital gain (after ADC) can be applied to the image. The digital gain has to be adjusted based on the bit mode for a unity gain.

Figure 82:
Gain Settings

Reg. Name	Address	Bits	Default	Description
PGA_gain	115	[2:0]	0	0: x1 1: x2 3: x3 7: x4
PGA_div	115	[3]	0	Can be used in binning mode 0: Divide by 1 1: Divide by 3
Dig_gain	117	[4:0]	4	Set to 1,2,3,4,6,8,10,12,14,16 to get the appropriate digital gain. For unity gain use: 1: 12b 4: 10b 6: 8b

7.6.3 Electrical Black Reference Columns

The first and last eight columns of the pixel array can be changed to an electrical black reference. This electrical black reference can be used to correct row noise. The black level offset between the EB and normal pixels will differ. Because of the limited amount of EB pixels per row (16), row correction is limited.

Figure 83:
Electrical Black Reference Settings

Reg. Name	Address	Bits	Default	Description
Black_col_en	89	[15]	0	0: Off 1: On

7.6.4 Test Pattern

The sensor has a built-in digital fixed test pattern. This can be used, for example, to test the FPGA's data input implementation.

The pattern consists of increasing pixel values per column per channel. The first column of each (top and bottom) channel, offsets with 1 compared to the previous channel. So channels 1/33 will contain 0, 1, 2 ... 126, 127 and channels 2/34 contain 1, 2, 3 ... 127, 128 and channels 32/64 contain 31, 32, 33 ... 157, 158 and so on.

To have the same test pattern in 8b as in 10b and 12b, the digital gain has to be set to 16. Set it back to 6 when taking normal images again.

Figure 84:
Test Pattern Setting

Reg. Name	Address	Bits	Default	Description
Test	122	[1:0]	0	0: Off 3: On

Figure 85:
Test Pattern Image

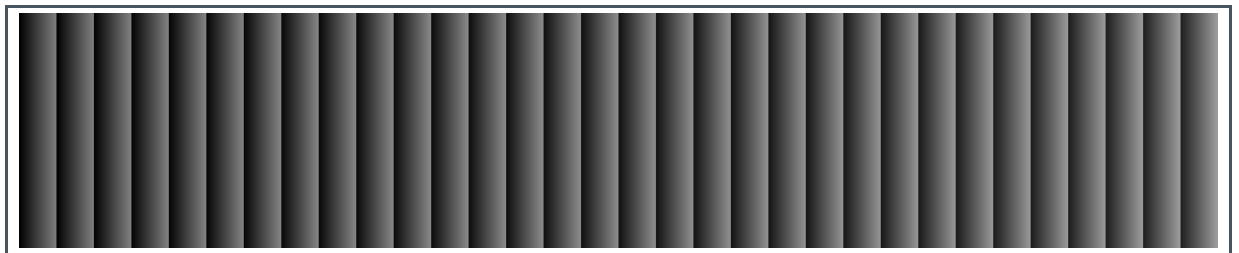
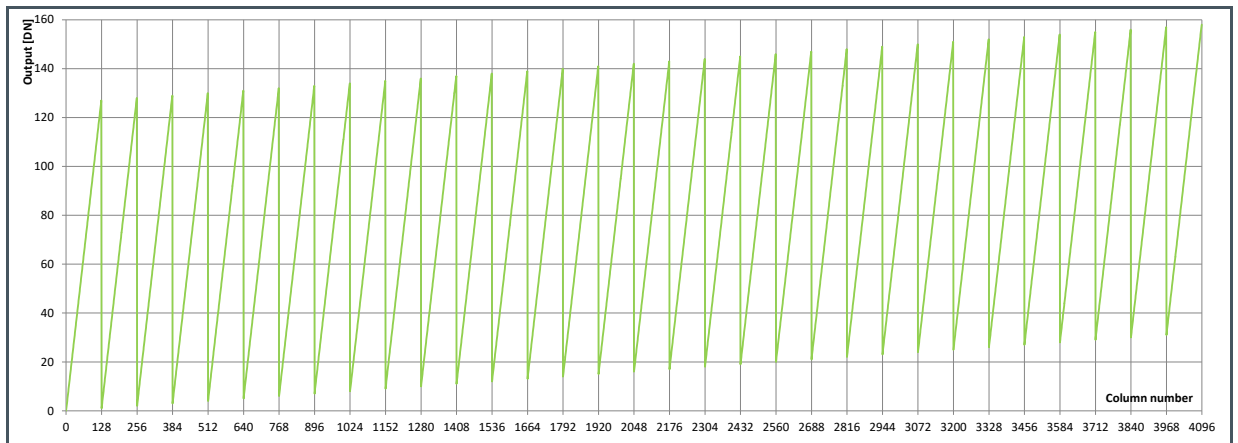

Figure 86:
Test Pattern Data



7.6.5 Temperature Sensor

A 16-bit digital temperature sensor is included in the image sensor and can be controlled by the SPI-interface. An input clock at pin CLK_IN must be applied to use the temperature sensor. The on-chip temperature can be calculated by reading out the Temp_sensor register.

The value in the temperature sensor register is dependent on the CLK_IN frequency. The value has an offset (so at 0°C the value in this register is not 0) and a slope (DN/°C). Both are input clock dependent. For example, if you read out a value of 1000DN at 40MHz, you will read a value of 500DN at 20MHz at the same temperature.

The offset and slope values will vary between devices. The typical offset and slope values are:

Equation 6:

$$Offset [DN] = \frac{825 \times f_{CLK_IN}}{30}$$

Equation 7:

$$Slope \left[\frac{DN}{^\circ C} \right] = \frac{3.5 \times f_{CLK_IN}}{30}$$

As the offset value varies between devices, at least a 1-point calibration per device should be done at a known temperature to compensate this offset. As the slope variation is and has less of an influence on the accuracy, a 2-point calibration is only needed if higher accuracy of the temperature is needed.

Below is an example of two devices (CLK_IN = 60 MHz) register values at different temperatures. The offset and slope vary about 300DN and 0.5DN/°C between each other. You can clearly see that not calibrating for the offset difference (so using 1600DN) will result in a very large error while using the typical 7DN/°C will yield only small inaccuracy.

Figure 87:
Temperature Sensor Calibration Examples

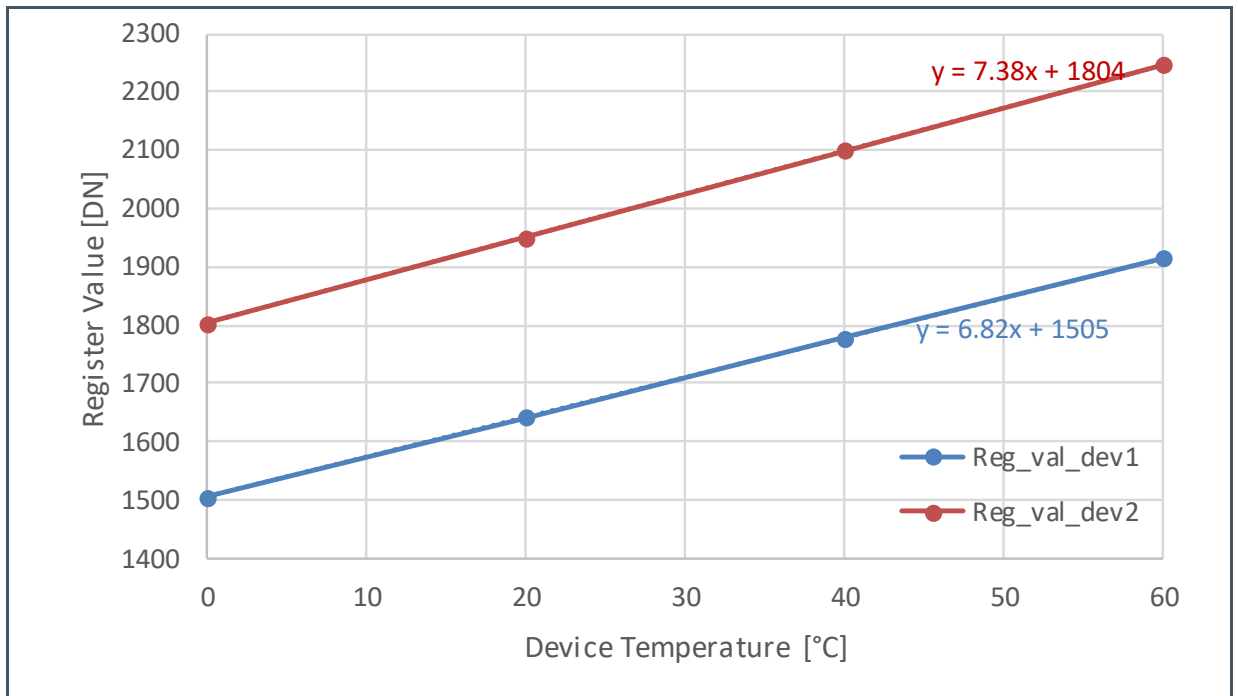
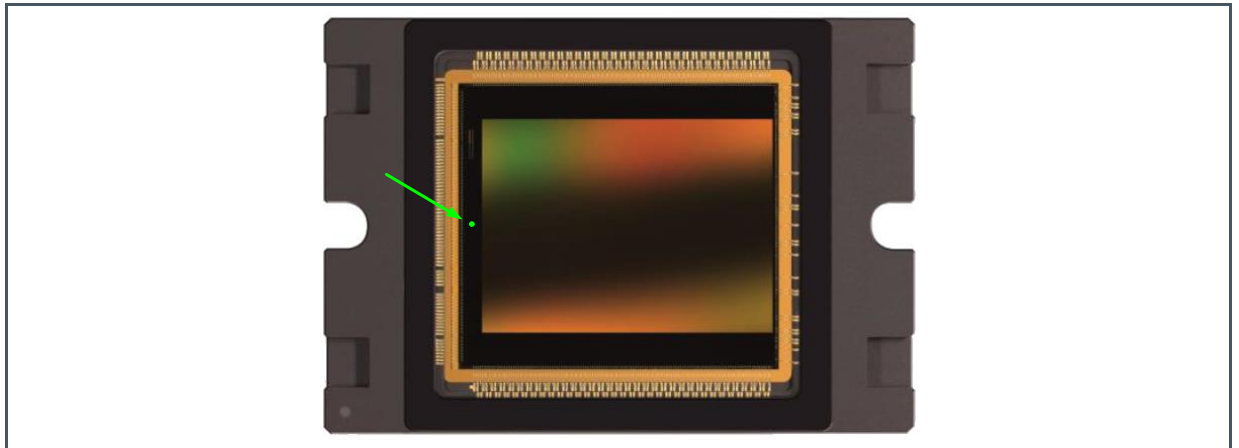

Figure 88:
Temperature Sensor Register

Reg. Name	Address	Bits	Default	Description
Temp_sensor	127	[15:0]	-	Read-Only. Contains a value for calculating the sensor temperature.

The on-chip temperature sensor is located in the middle of the left side. See Figure 89.

Figure 89:
Temperature Sensor Location



7.6.6 Digital Test Outputs

The sensor has two digital test output pins (TDIG1, TDIG2), which can be used to easily monitor the sensor state without using the high-speed LVDS control channel.

Use register 123[7:0] to program the output functionality:

Figure 90:
Digital Test Pins

Reg123[3:0]	TDIG1	Reg123[7:4]	TDIG2
0	LVAL	0	DVAL
2	FOT	3	INTE_1
3	INTE_2	5	CLK_PIX (= Output clock divided by the bit mode)
		15	FVAL

7.7 Additional Required Register Settings

Depending on the mode or clock speed of the sensor, some additional registers are required to be set.

7.7.1 8b Mode

These settings need to be adjusted per number of channels used per side and normal, X&Y-subsampling or binning mode.

Figure 91:
Additional Required Settings for 8b Mode

Mode	Number of Outputs Per Side					
	32	16	8	4	2	1
Normal Mode						
82	3618	2082	1058	546	290	290
83	5894	5896	5896	5896	5896	5896
84	143	143	143	143	143	143
85	143	257	515	1031	2063	4127
86	143	257	515	1031	2063	4127
87	510	510	510	510	510	510
88	510	510	510	510	510	510
98	36362	36362	36362	36362	36362	36362
107	11614	11614	11614	11614	11614	11614
109	13416	13416	13416	13416	13416	13416
113	788	788	788	788	788	788
114	90	90	90	90	90	90
X&Y-Subsampling						
82	2338	2082	1058	546	290	290
83	5893	5893	5893	5893	5893	5893
84	143	143	143	143	143	143
85	239	257	515	1031	2063	4127
86	119	128	257	515	1031	2063
87	510	510	510	510	510	510
88	510	510	510	510	510	510
98	36621	36621	36621	36621	36621	36621
107	11614	11614	11614	11614	11614	11614
109	13416	13416	13416	13416	13416	13416
113	791	791	791	791	791	791
114	93	93	93	93	93	93
Binning						
82	802	802	802	546	290	290
83	5896	5896	5896	5896	5896	5896
84	163	163	163	163	163	163
85	767	767	767	1031	2063	4127
86	191	191	191	257	515	1031
87	360	360	360	360	360	360
88	360	360	360	360	360	360
98	36618	36618	36618	36618	36618	36618
107	11614	11614	11614	11614	11614	11614

Mode	Number of Outputs Per Side					
Reg. Address	32	16	8	4	2	1
109	13416	13416	13416	13416	13416	13416
113	1571	1571	1571	1571	1571	1571
114	90	90	90	90	90	90

7.7.2 10b Mode

These settings need to be adjusted per number of channels used per side and normal, X&Y-subsampling or binning mode.

Figure 92:
Additional Required Settings for 10b Mode

Mode	Number of Outputs Per Side					
Reg. Address	32	16	8	4	2	1
Normal Mode						
82	3099	1563	795	539	283	283
83	5893	12805	12805	12805	12805	12805
84	128	128	128	128	128	128
85	128	257	515	1031	2063	4127
86	128	257	515	1031	2063	4127
87	540	540	540	540	540	540
88	540	524	524	524	524	524
98	44812	44812	44812	44812	44812	44812
107	11614	11614	11614	11614	11614	11614
109	13416	13416	13416	13416	13416	13416
113	789	789	789	789	789	789
114	84	84	84	84	84	84
X&Y-Subsampling						
82	2843	1563	795	539	283	283
83	5891	5893	5893	5893	5893	5893
84	143	257	257	257	257	257
85	143	257	515	1031	2063	4127
86	71	128	257	515	1031	2063
87	550	480	480	480	480	480
88	540	480	480	480	480	480
98	44815	36620	36620	36620	36620	36620
107	11614	11614	11614	11614	11614	11614
109	13416	13416	13416	13416	13416	13416

Mode	Number of Outputs Per Side						
	Reg. Address	32	16	8	4	2	1
113	798	1586	1586	1586	1586	1586	1586
114	90	109	109	109	109	109	109
Binning							
82	798	798	798	542	286	286	286
83	5894	5894	5894	5898	5908	5908	5908
84	575	575	575	575	575	575	575
85	575	575	575	1031	2063	4127	4127
86	143	143	143	257	515	1031	1031
87	630	630	630	630	630	630	630
88	630	630	630	630	630	630	630
98	36619	36619	36619	36619	36619	36619	36619
107	11606	11606	11606	11606	11606	11606	11606
109	13416	13416	13416	13416	13416	13416	13416
113	1054	1054	1054	1054	1054	1054	1054
114	100	100	100	100	100	100	100

7.7.3 12b Mode

These settings need to be adjusted per number of channels used per side and normal, X&Y- subsampling or binning mode.

Figure 93:
Additional Required Settings for 12b Mode

Mode	Number of Outputs Per Side						
	Reg. Address	32	16	8	4	2	1
Normal Mode							
82	1822	1822	1054	542	286	286	286
83	5897	5897	5897	5897	5897	5897	5897
84	244	257	257	257	257	257	257
85	244	257	515	1031	2063	4127	4127
86	244	257	515	1031	2063	4127	4127
87	1910	1910	1910	1910	1910	1910	1910
88	1910	1910	1910	1910	1910	1910	1910
98	39433	39433	39433	39433	39433	39433	39433
107	11102	11102	11102	11102	11102	11102	11102
109	14835	14448	14448	14448	14448	14448	14448
113	534	542	542	542	542	542	542

Mode	Number of Outputs Per Side					
	32	16	8	4	2	1
Reg. Address	32	16	8	4	2	1
114	200	200	200	200	200	200
X&Y-Subsampling						
82	2078	3102	1054	542	286	286
83	5893	5893	5893	5893	5893	5893
84	239	257	257	257	257	257
85	239	257	515	1031	2063	4127
86	119	128	257	515	1031	2063
87	1975	1935	1935	1935	1935	1935
88	1975	1935	1915	1915	1915	1915
98	36364	36364	36364	36364	36364	36364
107	11102	11102	11102	11102	11102	11102
109	14835	14835	14835	14835	14835	14835
113	529	542	542	542	542	542
114	190	200	200	200	200	200
Binning						
82	1054	1054	1054	542	286	286
83	5893	5893	5893	5898	5898	5898
84	479	479	479	479	479	479
85	479	479	515	1031	2063	4127
86	119	119	128	257	515	1031
87	1255	1255	1425	1425	1425	1425
88	1255	1255	1425	1425	1425	1425
98	36620	36620	36620	36620	36620	36620
107	11102	11102	11102	11102	11102	11102
109	14835	14835	14835	14835	14835	14835
113	13342	13342	9246	7710	7710	7710
114	200	200	200	200	200	200

7.7.4 Clock Speed

Some settings need to be changed depending on the clock speed.

FOT

When you are running at a lower speed, register 107[13:7] has to be adjusted to keep the image quality good. The plots below give you an overview, which value to choose per bit mode. Round down if the recommended register value is between integers.

Figure 94:
FOT Register vs Clock Speed

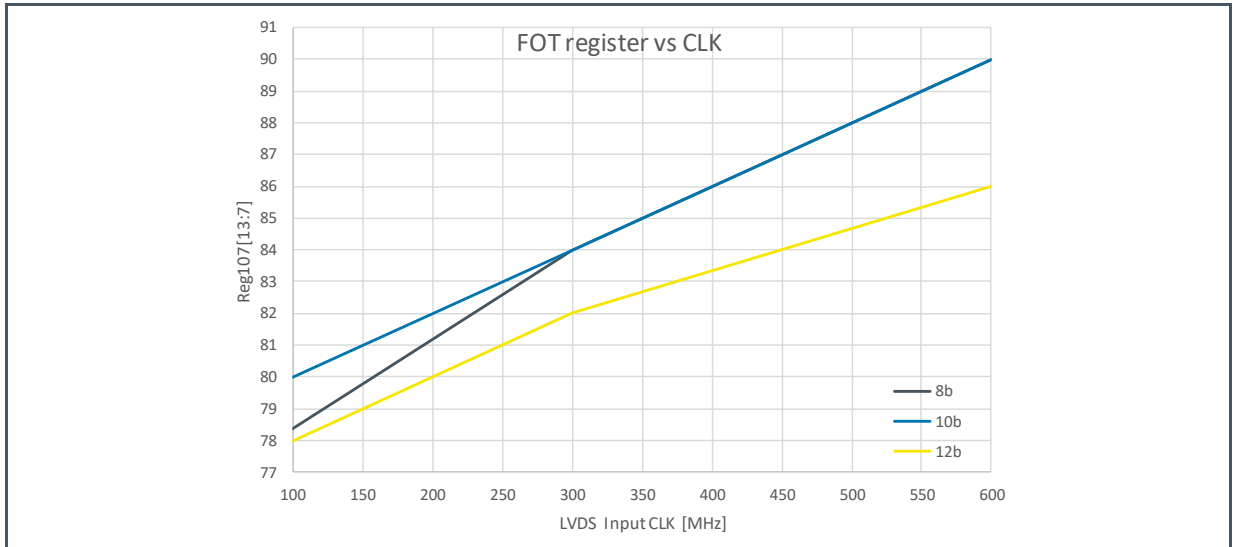

Information

Bits [6:0] of register 107 do not change with clock speed. Keep these bits always the same, at the recommended value from previous sections. For example at 10b default mode, register 107 = 11614, so bits [6:0] should remain 94.

ADC Range

The ADC range is dependent of the input clock speed, the slower the clock the higher the ADC range setting has to be. Below you can see a plot showing which ADC range and multipliers to use with a certain clock speed and bit mode.

The multiplier registers set the total multiplication for the ADC input range. The table below gives an overview of the total multiplication (used in Figure 96) that is applicable.

For example, when running at 400 MHz, make a vertical line on this frequency until crossing all 3 diagonal lines. Crossing the dashed yellow line, this refers to 12b_mult_x16. Then, find x16 on the table from Figure 95, finally, you should use the values:

- ADC_range = 70, ADC_range_mult = 3, ADC_range_mult2 = 3 for 12b ADC.
- ADC_range = 220, ADC_range_mult = 1, ADC_range_mult2 = 0 for 10b ADC.
- ADC_range = 247, ADC_range_mult = 0, ADC_range_mult2 = 0 for 8b ADC.

Figure 95:
ADC Range Multiplication

ADC_range_mult2	ADC_range_mult 0	ADC_range_mult 1	ADC_range_mult 3
0	x1	x2	x4
1	N/A	N/A	x8
3	N/A	N/A	x16

Figure 96:
ADC Range Settings

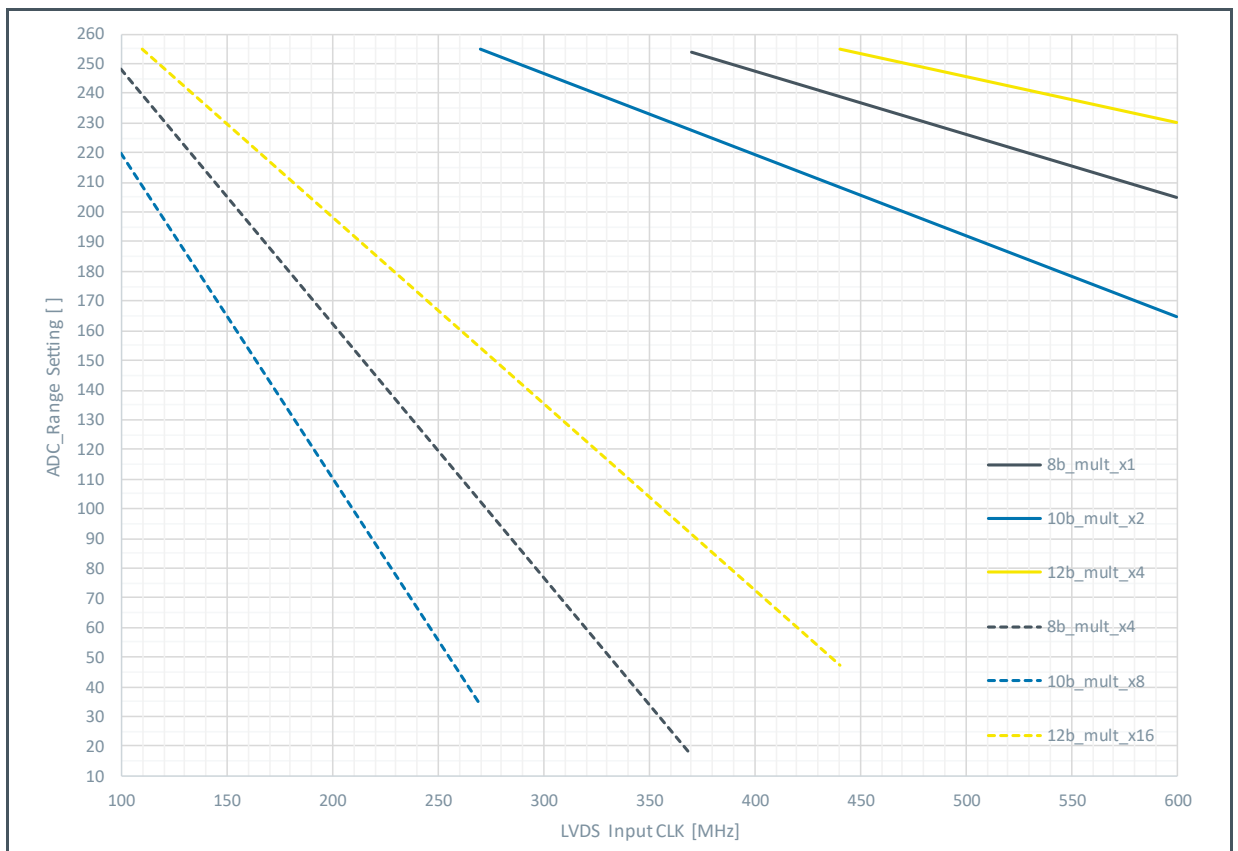

8 Register Description

8.1 Register Categories

The registers are grouped into various categories, based on when they may (or not may) be updated and synced. The table below explains the details of the various categories.

Figure 97:
Register Categories

Category	Description
-	Register without category that can be uploaded at any time, but might directly influence the sensor execution.
SYNC	Registers are internally synchronized to the end of FOT, so the read out will be done with these registers applied. Registers can only be uploaded during IDLE or FOT.
FRAME	Registers will be internally synced at FRAME_REQ. Registers can only be uploaded during IDLE.
INTE	Registers will be internally synced at start of INTE. Registers can only be uploaded during IDLE or FOT.
DC	Registers will be internally synced immediately. Registers can only be uploaded during IDLE or FOT.
IDLE	Registers will be internally synced immediately. Registers can only be uploaded when the sensor is IDLE.
RO	Registers can be read only.

8.2 Register Overview

Below is an overview of all registers, together with their default value after reset/startup. Some registers have to be changed to another fixed value after reset/startup, independent on the sensor control or modes. This value is in the last column.

Figure 98:
Register Overview

Address	Register Name(s)	Category	Default Value	Fixed Value
0		-	0	
1	Number_lines_tot[15:0]	SYNC	3072	
2	Y_start_1[15:0]	SYNC	0	
3	Y_start_2[15:0]	SYNC	0	
4	Y_start_3[15:0]	SYNC	0	

Address	Register Name(s)	Category	Default Value	Fixed Value
5	Y_start_4[15:0]	SYNC	0	
6	Y_start_5[15:0]	SYNC	0	
7	Y_start_6[15:0]	SYNC	0	
8	Y_start_7[15:0]	SYNC	0	
9	Y_start_8[15:0]	SYNC	0	
10	Y_start_9[15:0]	SYNC	0	
11	Y_start_10[15:0]	SYNC	0	
12	Y_start_11[15:0]	SYNC	0	
13	Y_start_12[15:0]	SYNC	0	
14	Y_start_13[15:0]	SYNC	0	
15	Y_start_14[15:0]	SYNC	0	
16	Y_start_15[15:0]	SYNC	0	
17	Y_start_16[15:0]	SYNC	0	
18	Y_start_17[15:0]	SYNC	0	
19	Y_start_18[15:0]	SYNC	0	
20	Y_start_19[15:0]	SYNC	0	
21	Y_start_20[15:0]	SYNC	0	
22	Y_start_21[15:0]	SYNC	0	
23	Y_start_22[15:0]	SYNC	0	
24	Y_start_23[15:0]	SYNC	0	
25	Y_start_24[15:0]	SYNC	0	
26	Y_start_25[15:0]	SYNC	0	
27	Y_start_26[15:0]	SYNC	0	
28	Y_start_27[15:0]	SYNC	0	
29	Y_start_28[15:0]	SYNC	0	
30	Y_start_29[15:0]	SYNC	0	
31	Y_start_30[15:0]	SYNC	0	
32	Y_start_31[15:0]	SYNC	0	
33	Y_start_32[15:0]	SYNC	0	
34	Y_size_1[15:0]	SYNC	0	
35	Y_size_2[15:0]	SYNC	0	
36	Y_size_3[15:0]	SYNC	0	
37	Y_size_4[15:0]	SYNC	0	
38	Y_size_5[15:0]	SYNC	0	
39	Y_size_6[15:0]	SYNC	0	
40	Y_size_7[15:0]	SYNC	0	
41	Y_size_8[15:0]	SYNC	0	
42	Y_size_9[15:0]	SYNC	0	
43	Y_size_10[15:0]	SYNC	0	
44	Y_size_11[15:0]	SYNC	0	

Address	Register Name(s)	Category	Default Value	Fixed Value
45	Y_size_12[15:0]	SYNC	0	
46	Y_size_13[15:0]	SYNC	0	
47	Y_size_14[15:0]	SYNC	0	
48	Y_size_15[15:0]	SYNC	0	
49	Y_size_16[15:0]	SYNC	0	
50	Y_size_17[15:0]	SYNC	0	
51	Y_size_18[15:0]	SYNC	0	
52	Y_size_19[15:0]	SYNC	0	
53	Y_size_20[15:0]	SYNC	0	
54	Y_size_21[15:0]	SYNC	0	
55	Y_size_22[15:0]	SYNC	0	
56	Y_size_23[15:0]	SYNC	0	
57	Y_size_24[15:0]	SYNC	0	
58	Y_size_25[15:0]	SYNC	0	
59	Y_size_26[15:0]	SYNC	0	
60	Y_size_27[15:0]	SYNC	0	
61	Y_size_28[15:0]	SYNC	0	
62	Y_size_29[15:0]	SYNC	0	
63	Y_size_30[15:0]	SYNC	0	
64	Y_size_31[15:0]	SYNC	0	
65	Y_size_32[15:0]	SYNC	0	
66	Sub_offset[15:0]	SYNC	0	
67	Sub_step[15:0]	SYNC	1	
68	Color[3], Bin_en[2], Sub_en[1], Color[0]	IDLE	9	
69	Image_flipping[1:0]	DC	0	
70	Exp_dual[1], Exp_ext[0]	IDLE	0	
71	Exp_time[15:0]	INTE	1536	
72	Exp_time[23:16]	INTE	0	
73	Exp_time2[15:0]	INTE	1536	
74	Exp_time2[23:16]	INTE	0	
75	Exp_kp1[15:0]	INTE	0	
76	Exp_kp1[23:16]	INTE	0	
77	Exp_kp2[15:0]	INTE	0	
78	Exp_kp2[23:16]	INTE	0	
79	Number_slopes[1:0]	INTE	1	
80	Number_frames[15:0]	FRAME	1	
81	Disable_top[5], Output_mode[4:0]	IDLE	0	
82		IDLE	5682	
83		IDLE	5893	
84		IDLE	130	

Address	Register Name(s)	Category	Default Value	Fixed Value
85		IDLE	130	
86		IDLE	130	
87	Offset_bot[11:0]	DC	780	
88	Offset_top[11:0]	DC	780	
89	Black_col_en[15], Training_pattern[14:0]	-	85	
90	Channel_en_bot[15:0]	IDLE	65535	
91	Channel_en_bot[31:16]	IDLE	65535	
92	Channel_en_top[15:0]	IDLE	65535	
93	Channel_en_top[31:16]	IDLE	65535	
94	Channel_en[2:0]	IDLE	7	
95	ADC_clk_en_bot[15:0]	IDLE	65535	
96	ADC_clk_en_top[15:0]	IDLE	65535	
97		IDLE	0	
98		IDLE	34952	
99		IDLE	34952	34956
100		IDLE	0	
101		IDLE	0	
102		IDLE	8256	8302
103		IDLE	4032	
104		IDLE	64	
105		IDLE	8256	
106	Vtf13[13:7], Vtf12[6:0]	IDLE	8256	
107		IDLE	12384	
108		IDLE	12384	12381
109	Vramp2[13:7], Vramp1[6:0]	IDLE	12384	
110		IDLE	12384	12368
111		IDLE	34952	
112		IDLE	0	277
113		IDLE	778	
114		IDLE	95	
115	PGA_div[3], PGA_gain[2:0]	IDLE	0	
116	ADC_range_mult[9:8], ADC_range[7:0]	IDLE	383	
117	DIG_gain[4:0]	IDLE	4	
118	Bit_mode[1:0]	IDLE	1	
119		IDLE	0	
120		IDLE	9	
121		IDLE	1	
122	Test_pattern[1:0]	IDLE	32	
123		-	0	
124		IDLE	5	15

Address	Register Name(s)	Category	Default Value	Fixed Value
125		IDLE	2	
126		RO	770	
127	Temp_sensor[15:0]	RO	0	

9 Application Information

9.1 Color Filter

For a color version of the CMV12000, the color filters are applied in a Bayer pattern. When flipping in Y is not enabled (register 69 =0), the first pixel read-out, pixel (0, 0), is the top left one and has a red filter. If register 69 is '2' (recommended), the bottom left pixel (0, 3071) is read-out first and it has a green filter.

Figure 99:
Color Filter Layout

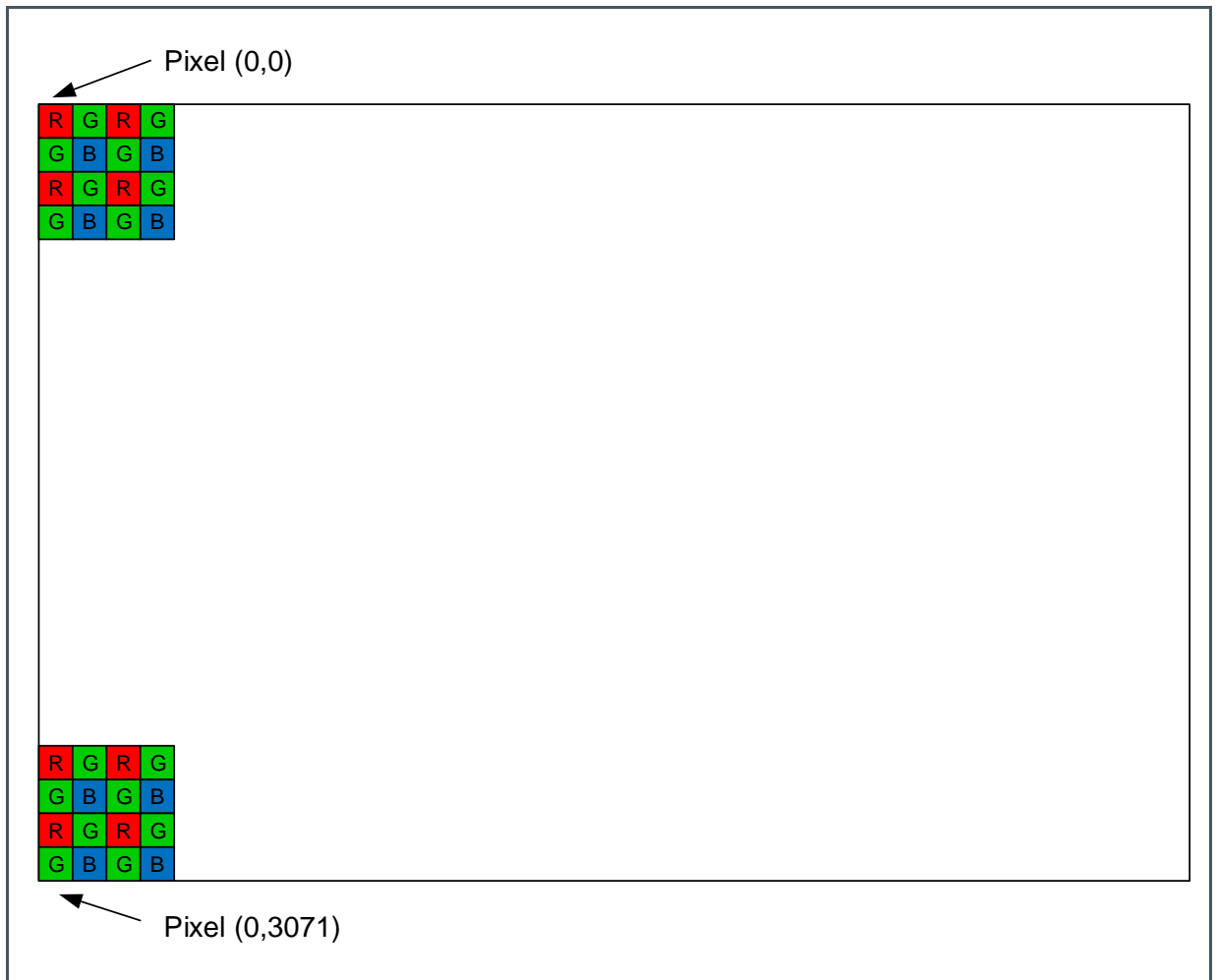

9.2 Socket

To avoid putting the sensor through the soldering heat (stressing the color filters and micro-lenses), it is advised to use a socket and place the sensor after the soldering phase. Sockets for this device are available from Andon Electronics (www.andonelectronics.com) in both SMD and THT configuration.

- 10-30-07(A)-237-400T4-R27-L14: THT
- 10-30-07(A)-237-414T4-R27-L14: SMD
- 10-30-07(A)-237-RB501T4-R27-L14: SMD

An optional window in the socket is possible (A) for easy access to the sensor backside. Contact Andon Electronics directly for more information.

9.3 Pin Layout

Figure 100:
Pin Layout from Bottom View

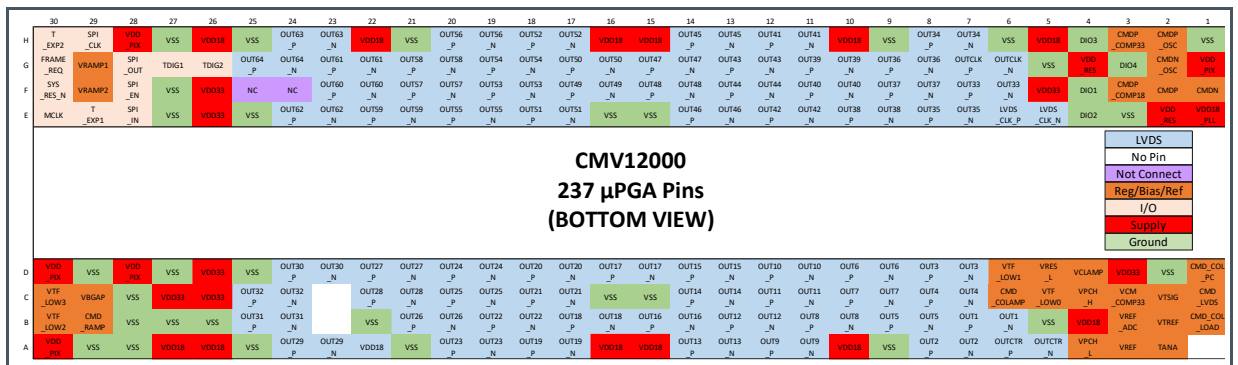

10 Package Drawings & Markings

Figure 101:
237p μ PGA Package Outline Drawing

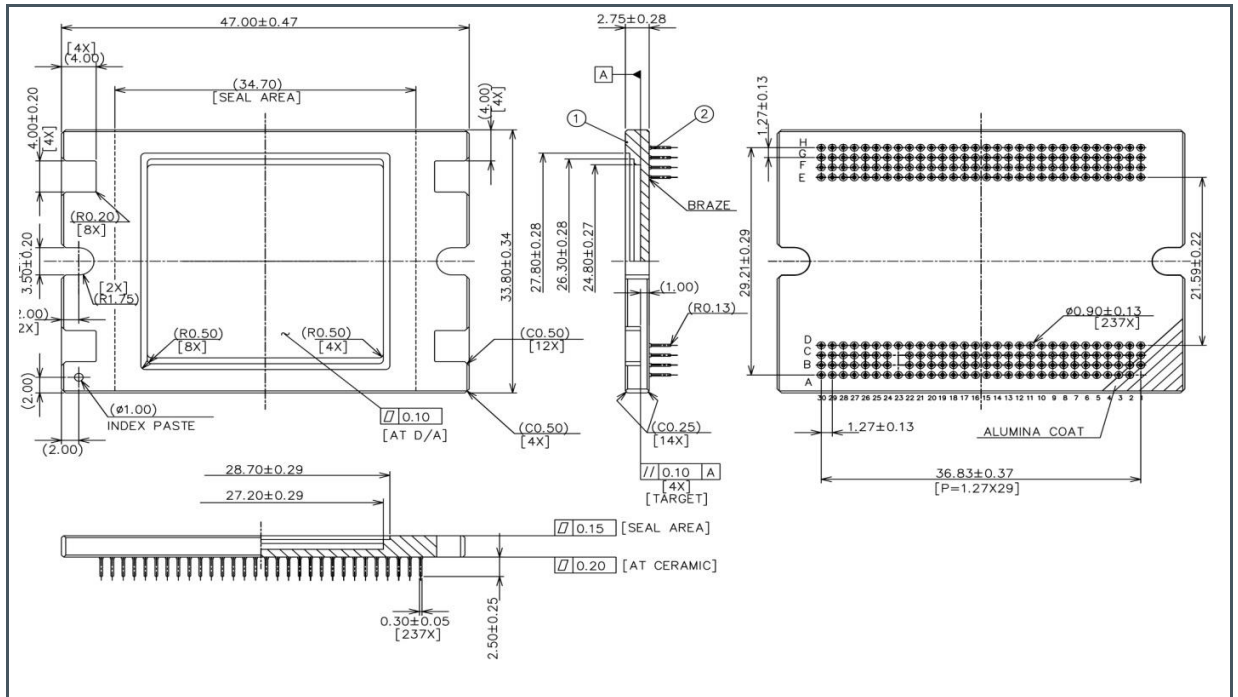

- (1) All dimensions are in mm
- (2) Pin material: Kovar
- (3) Pin plating: Au $1.5 \mu\text{m}$ min. over Ni $2.0 \mu\text{m}$ min.
- (4) Ceramic material: Alumina (Al_2O_3)
- (5) Ceramic properties: Thermal Conductivity = 18 W/m.K ; Young's mod = 280GPa ; CTE = $7.6 \times 10^{-6}/\text{K}$

Figure 102:
237p μ PGA Package Assembly Outline Drawing

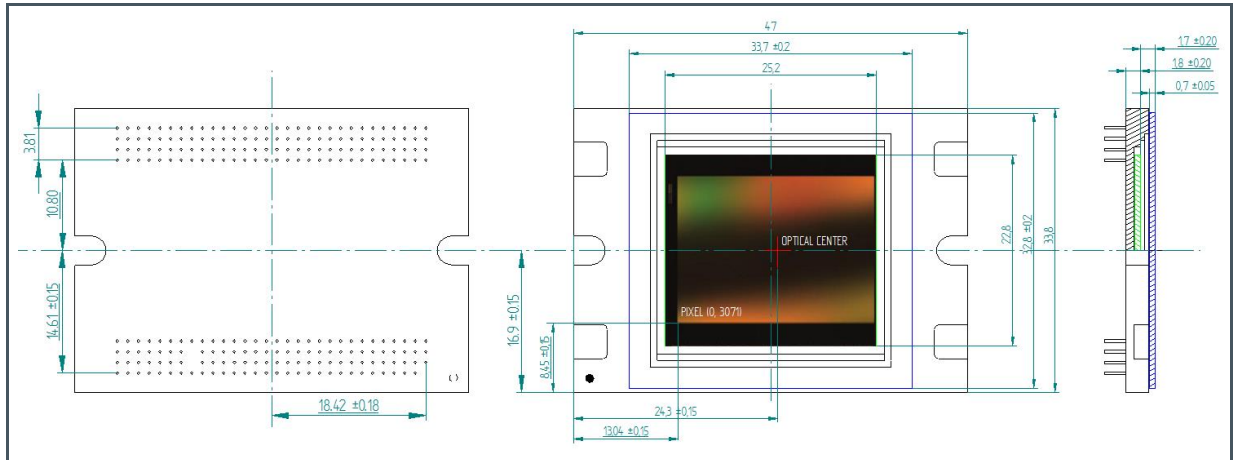

- (1) All dimensions are in mm
- (2) Rotation of the die referenced to the package outside: ± 0.5 degrees
- (3) Tilt of the die referenced to the die attach area (cavity bottom): ± 0.15 degrees
- (4) Distance top of pixel array to top of cover glass: 1.7 ± 0.20 mm
- (5) Cover glass: plain D263 with AR coating on both sides. When a color filter is used, an IR-cutoff filter should be placed in the optical path for color accuracy.

11 Packing Information

Devices are shipped in a 3x6 matrix 33.8x47 μ PGA JEDEC tray.

12 Soldering & Storage Information

12.1 Soldering

CMV12000 is not shipped in a moisture barrier package. When reflow soldering, a dry bake needs to be performed upfront! The CMV12000 device has passed MSL3 testing. Figure 103 shows the maximum recommended thermal profile for a reflow soldering system (following Standard J-STD-020). If the temperature/time profile exceeds these recommendations, damage to the image sensor can occur.



Attention

1. Image sensors with color filter arrays (CFA) and micro lenses are especially sensitive to high temperatures. Prolonged heating at elevated temperatures may result in deterioration of the optical performance of the sensor.
 2. A socket (see 9.2) is the safest way to avoid any thermal stress. When not using a socket, to avoid heating up the device we recommend to use manual hand soldering. Wave soldering can be used with precautions (see below). Reflow soldering is not recommended.
-

Manual soldering: Use partial heating method and use a soldering iron with temperature control. The soldering iron tip temperature is not to exceed 350 °C with a 270 °C maximum pin temperature. Touch for a 2 seconds maximum duration per pin. Avoid touching and global heating of the ceramic package during soldering. Failure to do so may alter device performance and reliability.

Wave soldering: Wave solder dipping can cause damage to the glass and harm the imaging capability of the device. Avoid the solder to come in contact with the glass or ceramic body.

Figure 103:
Solder Reflow Profile Graph

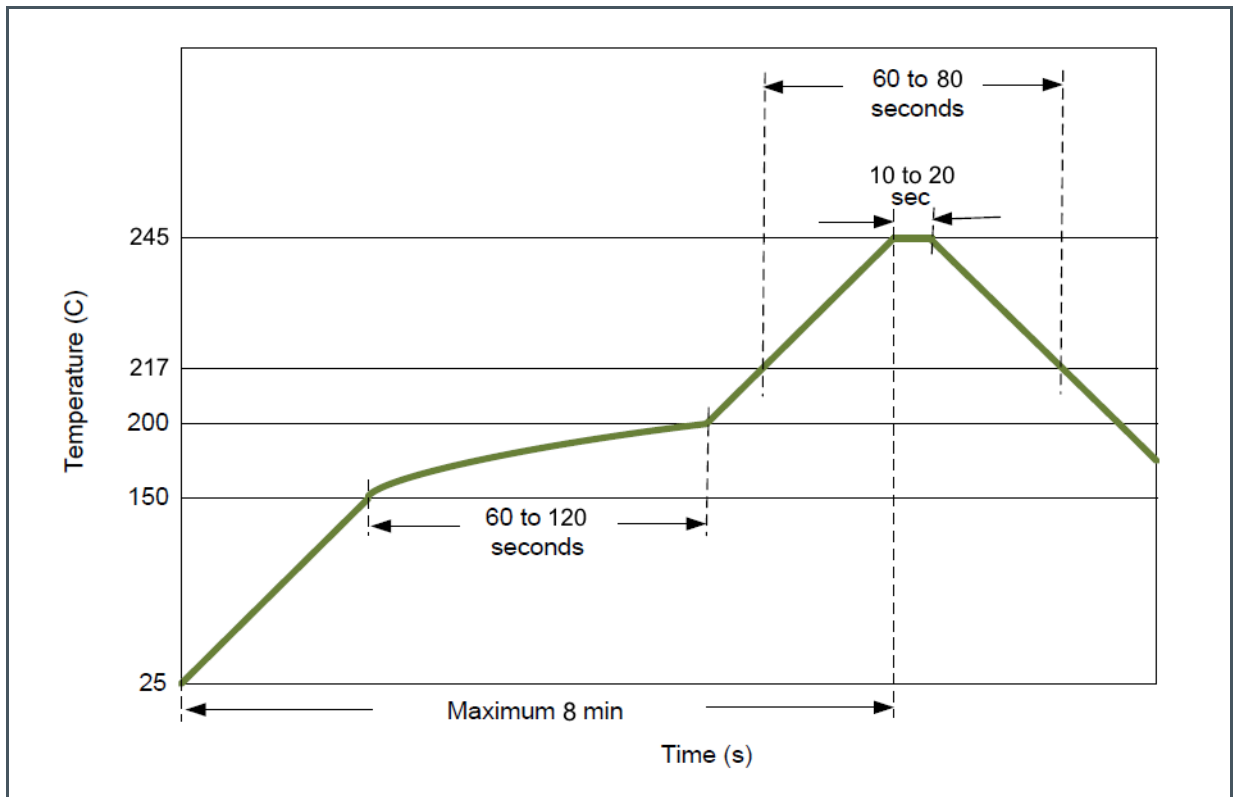

12.2 Storage

Image sensors should be stored under the following conditions:

- Dust free
- Temperature between 20 °C and 40 °C
- Humidity between 30% and 60% RH
- Avoid radiation, electromagnetic fields, ESD and mechanical stress

13 Revision Information

Document Status	Product Status	Definition
Product Preview	Pre-Development	Information in this datasheet is based on product ideas in the planning phase of development. All specifications are design goals without any warranty and are subject to change without notice
Preliminary Datasheet	Pre-Production	Information in this datasheet is based on products in the design, validation or qualification phase of development. The performance and parameters shown in this document are preliminary without any warranty and are subject to change without notice
Datasheet	Production	Information in this datasheet is based on products in ramp-up to full production or full production which conform to specifications in accordance with the terms of ams-OSRAM AG standard warranty as given in the General Terms of Trade
Datasheet (discontinued)	Discontinued	Information in this datasheet is based on products which conform to specifications in accordance with the terms of ams-OSRAM AG standard warranty as given in the General Terms of Trade, but these products have been superseded and should not be used for new designs

Changes from previous version to current revision v5-00	Page
Updated Functional Blocks	4
Added Ordering Information scheme	5
Corrected information about pin C3, F3, G2, H2 and H3	8, 10, 11 and 12
ADC Range example clarification and correction	69
Pin Layout image correction	77

- Page and figure numbers for the previous version may differ from page and figure numbers in the current revision.
- Correction of typographical errors is not explicitly mentioned.

14 Legal Information

Copyrights & Disclaimer

Copyright ams-OSRAM AG, Tobelbader Strasse 30, 8141 Premstaetten, Austria-Europe. Trademarks Registered. All rights reserved. The material herein may not be reproduced, adapted, merged, translated, stored, or used without the prior written consent of the copyright owner.

Devices sold by ams-OSRAM AG are covered by the warranty and patent indemnification provisions appearing in its General Terms of Trade. ams-OSRAM AG makes no warranty, express, statutory, implied, or by description regarding the information set forth herein. ams-OSRAM AG reserves the right to change specifications and prices at any time and without notice. Therefore, prior to designing this product into a system, it is necessary to check with ams-OSRAM AG for current information. This product is intended for use in commercial applications. Applications requiring extended temperature range, unusual environmental requirements, or high reliability applications, such as military, medical life-support or life-sustaining equipment are specifically not recommended without additional processing by ams-OSRAM AG for each application. This product is provided by ams-OSRAM AG "AS IS" and any express or implied warranties, including, but not limited to the implied warranties of merchantability and fitness for a particular purpose are disclaimed.

ams-OSRAM AG shall not be liable to recipient or any third party for any damages, including but not limited to personal injury, property damage, loss of profits, loss of use, interruption of business or indirect, special, incidental or consequential damages, of any kind, in connection with or arising out of the furnishing, performance or use of the technical data herein. No obligation or liability to recipient or any third party shall arise or flow out of ams-OSRAM AG rendering of technical or other services.

RoHS Compliant & ams Green Statement

RoHS Compliant: The term RoHS compliant means that ams-OSRAM AG products fully comply with current RoHS directives. Our semiconductor products do not contain any chemicals for all 6 substance categories plus additional 4 substance categories (per amendment EU 2015/863), including the requirement that lead not exceed 0.1% by weight in homogeneous materials. Where designed to be soldered at high temperatures, RoHS compliant products are suitable for use in specified lead-free processes.

ams Green (RoHS compliant and no Sb/Br/Cl): ams Green defines that in addition to RoHS compliance, our products are free of Bromine (Br) and Antimony (Sb) based flame retardants (Br or Sb do not exceed 0.1% by weight in homogeneous material) and do not contain Chlorine (Cl) not exceed 0.1% by weight in homogeneous material).

Important Information: The information provided in this statement represents ams-OSRAM AG knowledge and belief as of the date that it is provided. ams-OSRAM AG bases its knowledge and belief on information provided by third parties, and makes no representation or warranty as to the accuracy of such information. Efforts are underway to better integrate information from third parties. ams-OSRAM AG has taken and continues to take reasonable steps to provide representative and accurate information but may not have conducted destructive testing or chemical analysis on incoming materials and chemicals. ams-OSRAM AG and ams-OSRAM AG suppliers consider certain information to be proprietary, and thus CAS numbers and other limited information may not be available for release.

Headquarters

ams-OSRAM AG
Tobelbader Strasse 30
8141 Premstaetten
Austria, Europe
Tel: +43 (0) 3136 500 0

Please visit our website at www.ams.com

Buy our products or get free samples online at www.ams.com/Products

Technical Support is available at www.ams.com/Technical-Support

Provide feedback about this document at www.ams.com/Document-Feedback

For sales offices, distributors and representatives go to www.ams.com/Contact

For further information and requests, e-mail us at ams_sales@ams.com