

MB2S-G Thru. MB10S-G

Reverse Voltage: 200 to 1000 Volts

Forward Current: 0.8 Amp

RoHS Device

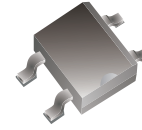

Features

- Ideal for printed circuit board
- High temperature soldering guaranteed:
260°C / 10 seconds /9.5mm
Lead length at 5 lbs.,(2.3kg) tension.

Mechanical data

- Case: Molded plastic.
- Lead: Solder plated.
- Polarity: As marked.
- Weight:0.13 gram(approx.).

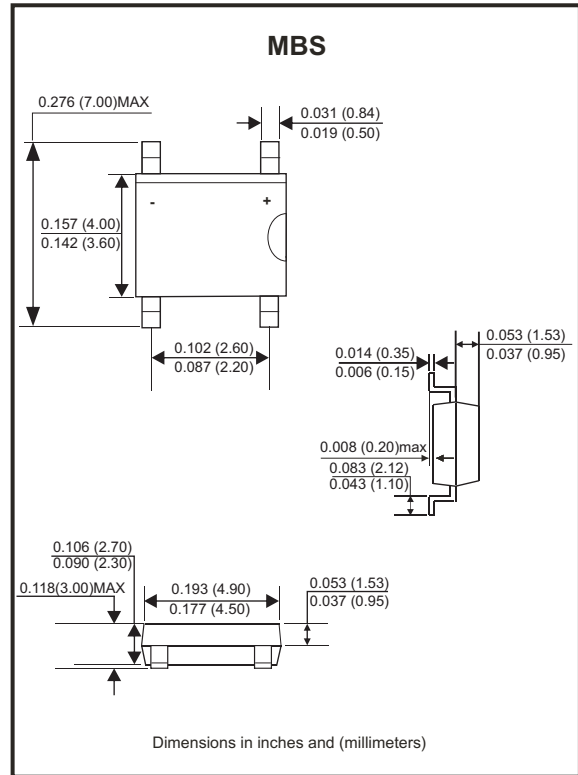

Maximum Rating And Electrical Characteristics

Rating at TA=25°C, unless otherwise noted.
Single phase, half wave, 60Hz, resistive or inductive load.
For capacitive load, derate current by 20%.

Parameter	Symbol	MB2S-G	MB4S-G	MB6S-G	MB8S-G	MB10S-G	Unit
Maximum Recurrent Peak Reverse Voltage	V _{RRM}	200	400	600	800	1000	V
Maximum RMS Voltage	V _{RMS}	140	280	420	560	700	V
Maximum DC Blocking Voltage	V _{DC}	200	400	600	800	1000	V
Maximum Average Forward Recurrent Current	I _(AV)	0.8					A
Peak Forward Surge Current, 8.3mS Single Half Sine-wave, Superimposed On Rated Load (JEDEC Method)	I _{FSM}	35					A
Maximum Instantaneous Forward Voltage at 0.4A	V _F	1.0					V
Maximum DC Reverse Current Rated DC Blocking Voltage per leg	@T _J =25°C	5.0					mA
	@T _J =125°C	500					
Typical Thermal Resistance (Note 1) (Note 2)	R _{θJA}	70					°C/W
	R _{θJL}	20					
Operating Temperature Range	T _J	-55 to +150					°C
Storage Temperature Range	T _{STG}	-55 to +150					°C

Notes: 1. On aluminum substrate P.C.B. with an area of 0.8x0.8"(20x20mm) mounted on 0.05x0.05"(1.3x1.3mm) solder pad.
2. On glass epoxy P.C.B. mounted on 0.05x0.05"(1.3x1.3mm) pads.

Rating and Characteristic Curves (MB2S-G Thru. MB10S-G)

Fig.1 - Maximum Forward Current Derating Curve

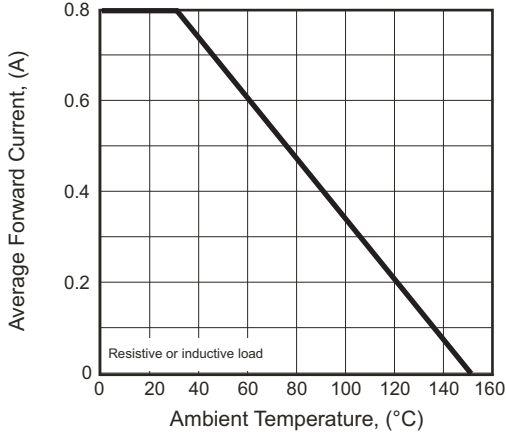

Fig.2 - Maximum Non-repetitive Forward Surge Current Per Bridge Element

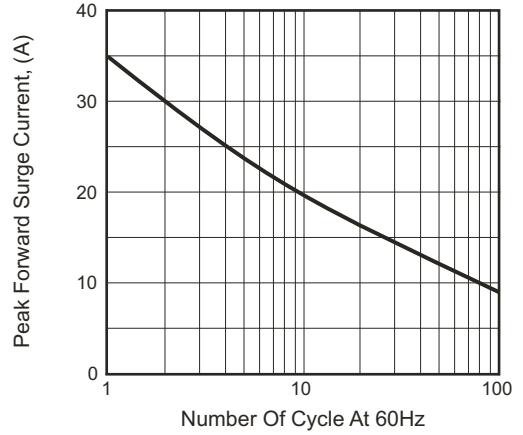

Fig.3 - Typical Instantaneous Forward Characteristics Per Bridge Element

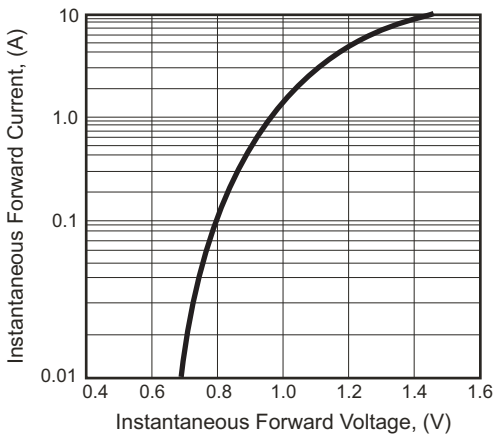
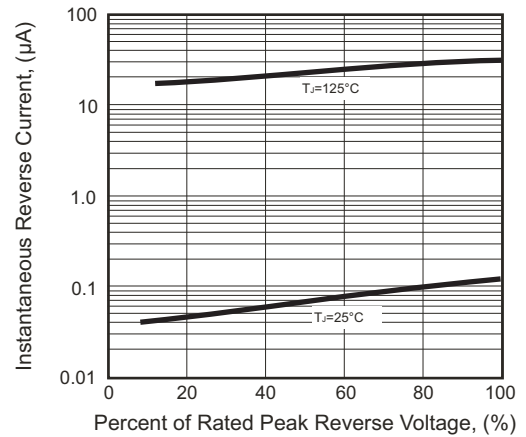
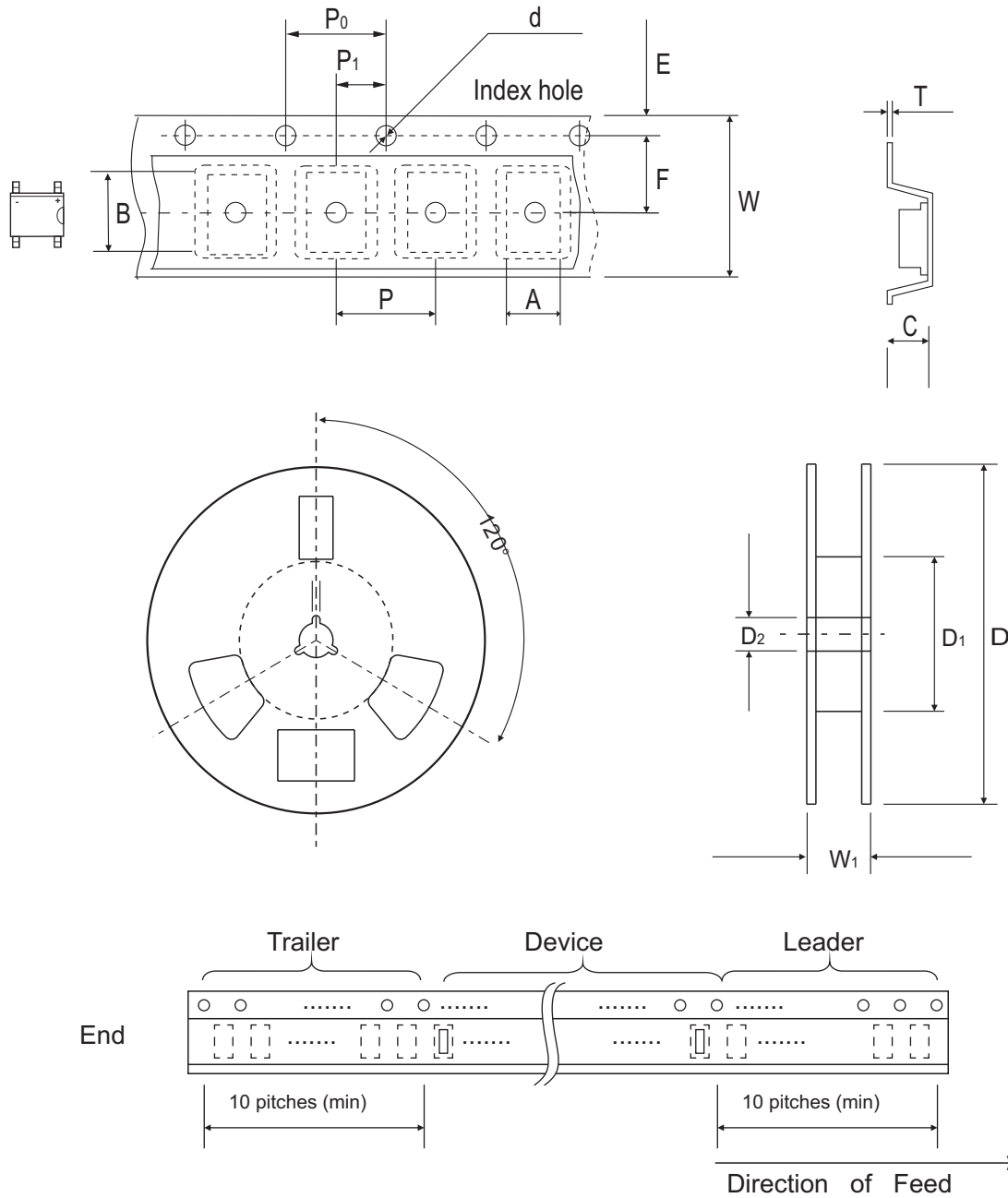

Fig.4 - Typical Reverse Characteristics Per Bridge Element



Reel Taping Specification



MBS	SYMBOL	A	B	C	d	D	D1	D2
	(mm)	5.00 ± 0.10	7.24 ± 0.10	2.95 ± 0.10	1.55 ± 0.05	330.00 ± 1.00	75.00 ± 1.00	14.00 ± 0.50
	(inch)	0.197 ± 0.004	0.285 ± 0.004	0.116 ± 0.004	0.061 ± 0.002	12.992 ± 0.039	2.953 ± 0.039	0.551 ± 0.020

MBS	SYMBOL	E	F	P	P0	P1	W	W1
	(mm)	1.75 ± 0.10	5.50 ± 0.05	8.00 ± 0.10	4.00 ± 0.10	2.00 ± 0.05	12.00 ± 0.30	18.4 ± 0.50
	(inch)	0.069 ± 0.004	0.217 ± 0.002	0.315 ± 0.004	0.157 ± 0.004	0.079 ± 0.002	0.472 ± 0.012	0.724 ± 0.020

Marking Code

Part Number	Marking Code
MB2S-G	MB2S
MB4S-G	MB4S
MB6S-G	MB6S
MB8S-G	MB8S
MB10S-G	MB10S

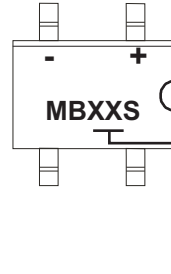

X/XX = Product type marking code

Suggested PAD Layout

SIZE	MBS	
	(mm)	(inch)
A	2.40	0.094
B	0.90	0.035
C	1.84	0.072
D	6.00	0.236

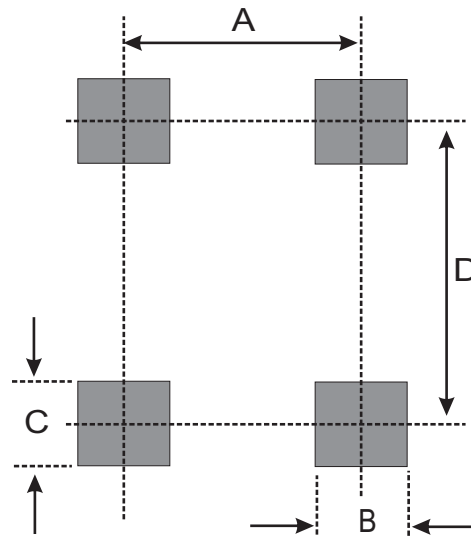

Standard Packaging

Case Type	Qty Per Reel	Reel Size
	(Pcs)	(inch)
MBS	2,500	13