

TDK-Lambda

i6A Series Evaluation Kit

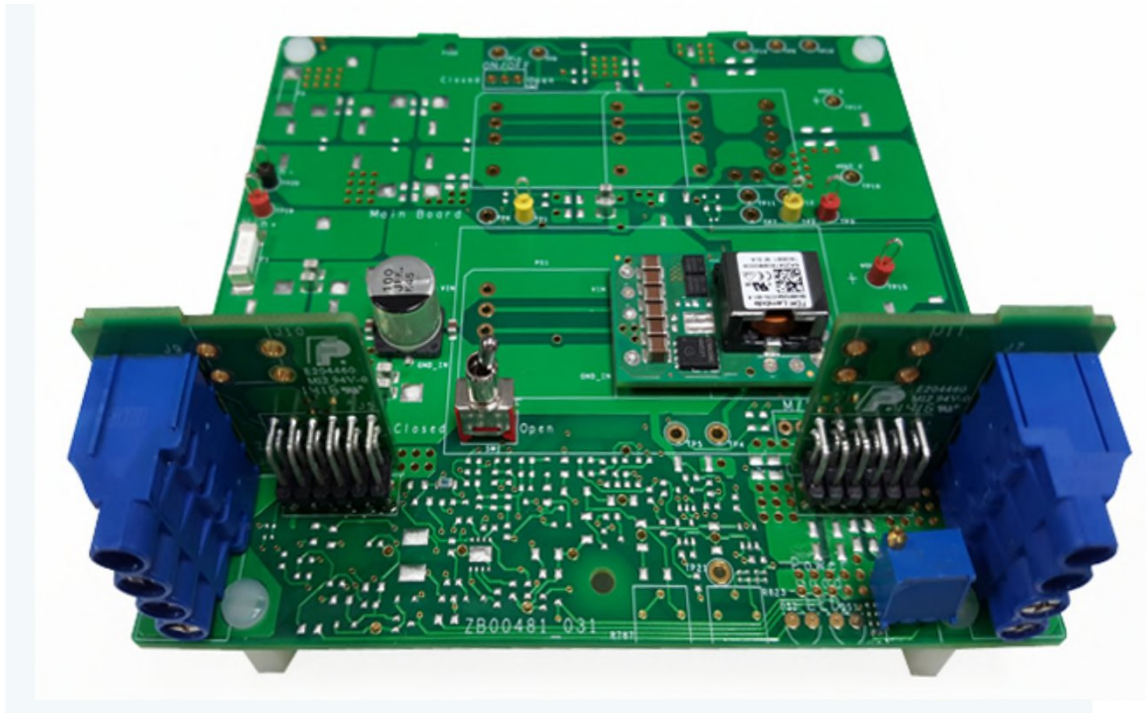

Part Number & Operating Range

- Single Output

- I6A14A-001-EVK-S1PX

Input Voltage	Output Voltage	Output Current	Maximum Output Power	Efficiency
9V-40V	3.3V to 24V	14A	250W	98%

- I6A20A-001-EVK-S1PX

Input Voltage	Output Voltage	Output Current	Maximum Output Power	Efficiency
9V-53V	3.3V to 15V	20A	250W	97%

- Dual Output

- I6A14A-001-EVK-D2PN

Input Voltage	Output Voltage	Output Current	Maximum Output Power	Efficiency
9V-40V	3.3V to 24V	14A	250W	98%
9V-40V	-3.3V to -30V	8A	75W	94%

- Constant Current Operation

- I6A20A-001-EVK-S1CC

Input Voltage	Output Voltage	Output Current	Maximum Output Power	Efficiency
9V-53V	3.3V to 15V	20A	250W	97%

Single Output

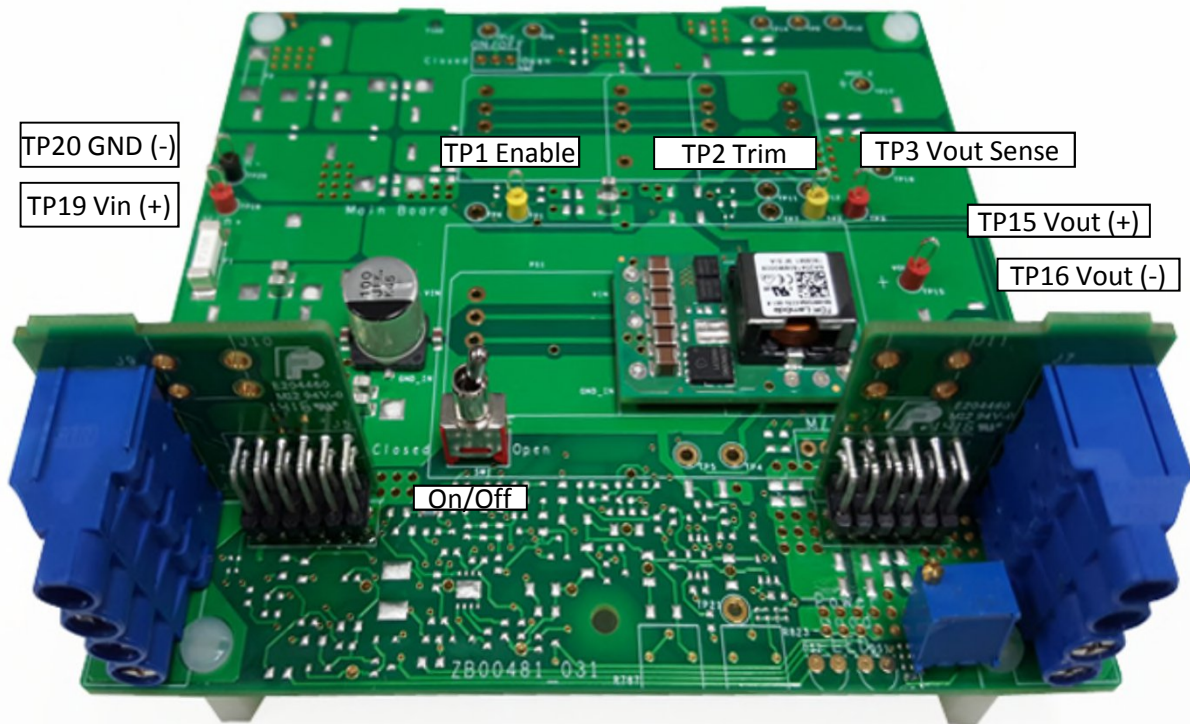

NC
Enable
Vin (-)
Vin (+)

Vout Trim Adjust

NC
NC
Vout (-)
Vout (+)

Dual Output

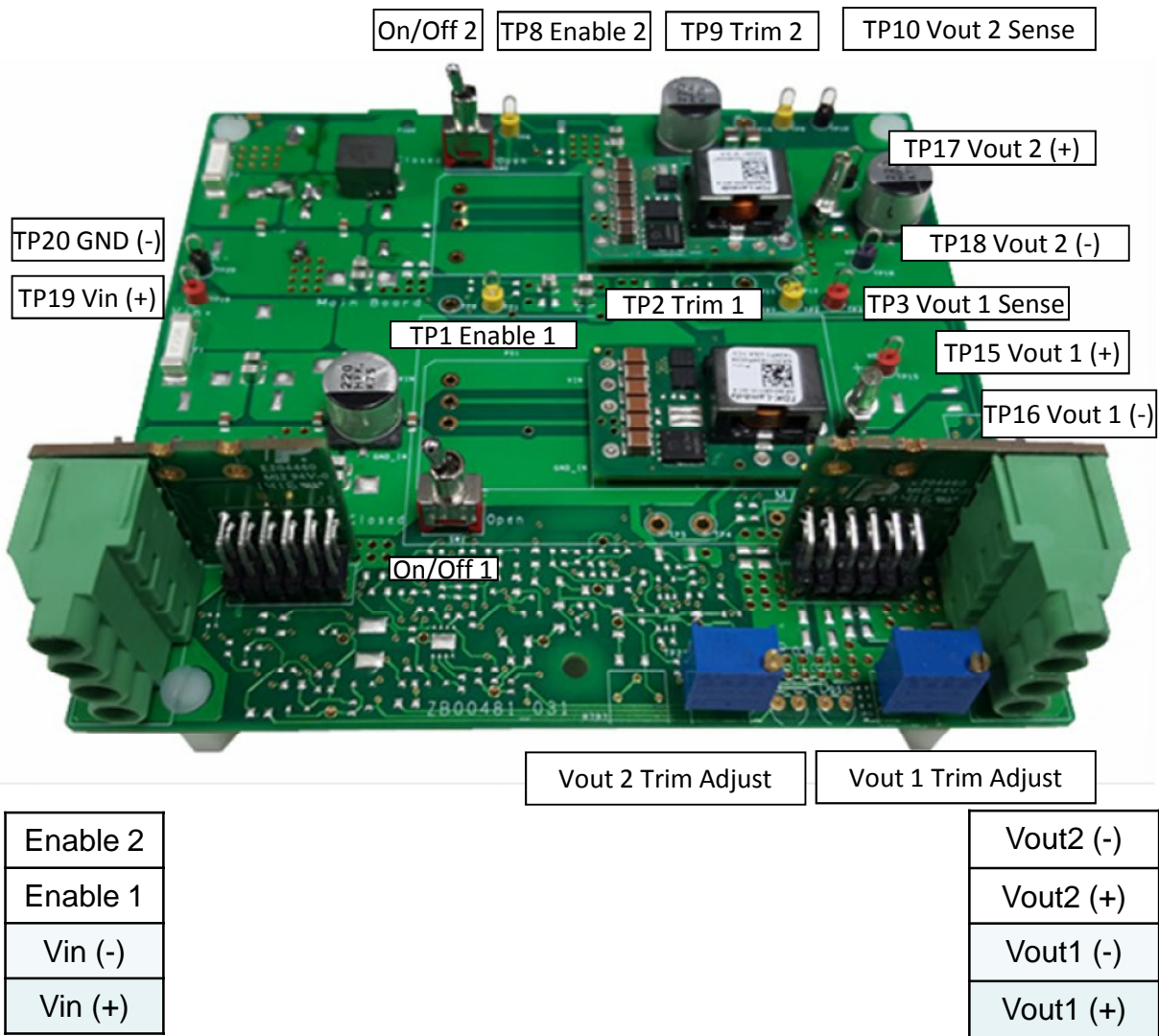
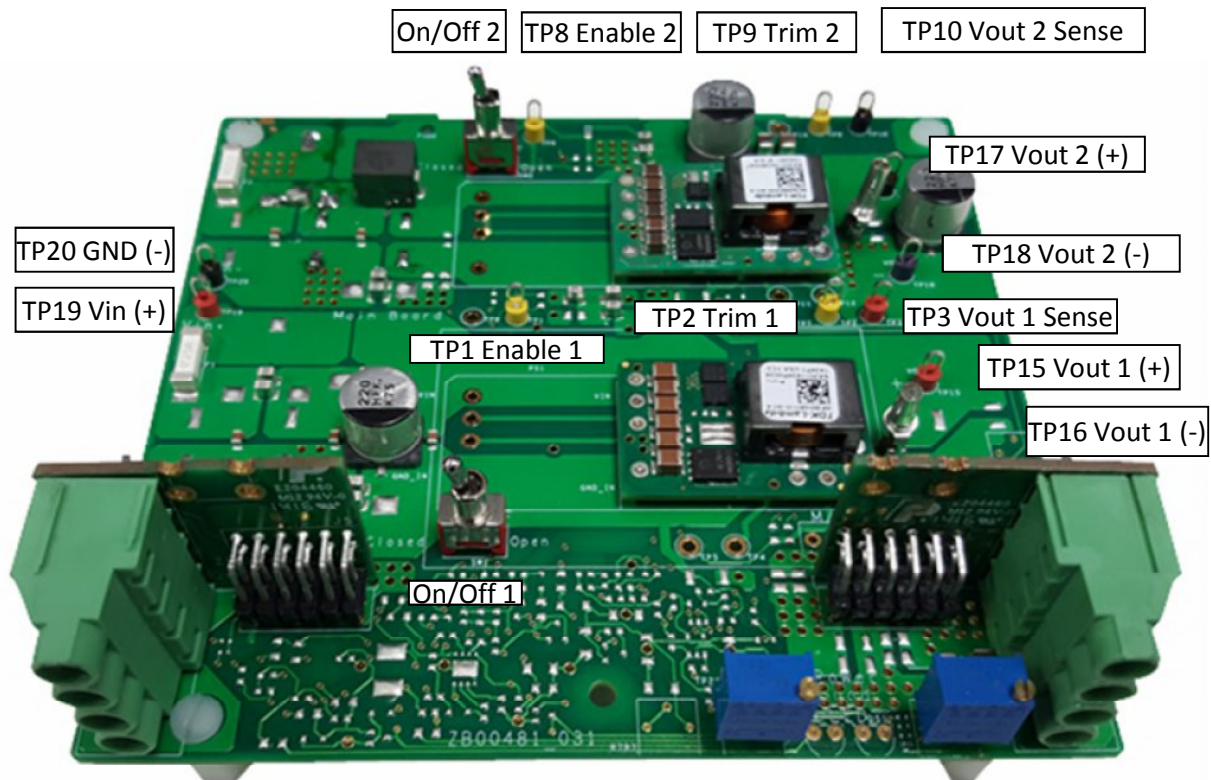

Constant Current

For constant current operation, please contact TDK Lambda Americas' Technical support.

TDK-Lambda Americas Inc.

401 Mile of Cars Way, Suite 325
National City, California 91950

Phone (800) 526-2324
www.us.tdk-lambda.com/lp

1. Once the input voltage is present, the module can be turned ON or OFF by using the ON/OFF toggle switch(s).
2. The user can change the output voltage by using Vout 1 or Vout 2 Trim adjust potentiometers.
3. Please note the specified operating ranges and keep in mind the positive output units are step-down converters. Please also see the product data sheets for more details about the specified operating range for specific units.

As an example for the i6A20A-001-EVK-S1PX:

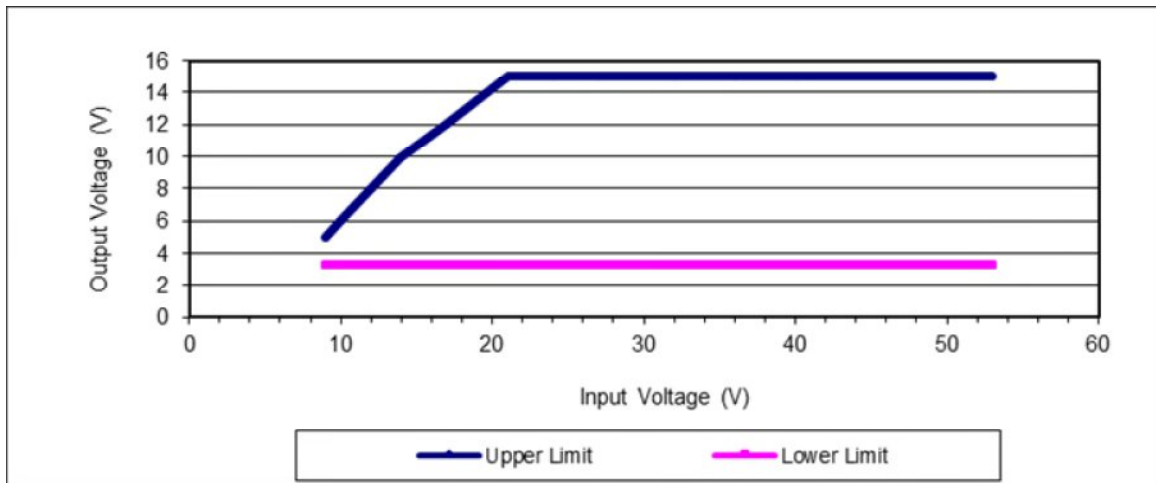

Set-up Example – Single Output



Set-up Example – Dual Output



Input voltage monitoring

Output voltage monitoring

Input connections

Output connections

Set-up Example – Single Output Using Scope

A scope probe can be connected at the input or output test points to observe dynamic performance such as start-up or transient response.

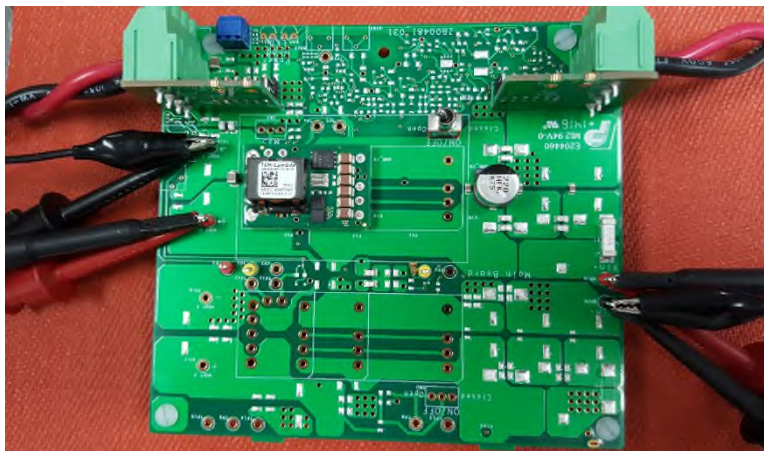

Be aware that the loop formed by the scope probe's ground lead may pick up spurious switching noise.

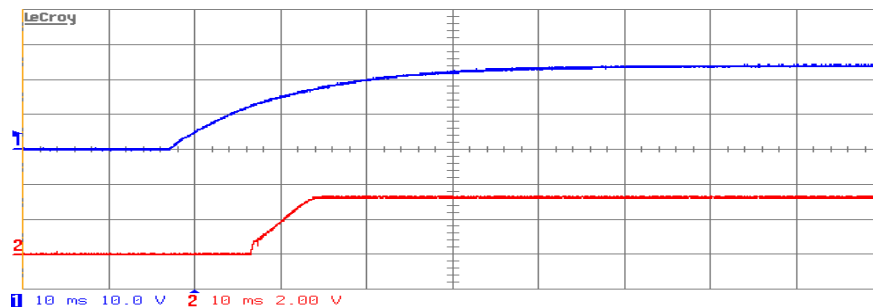

Blue – application of input voltage

Red – output voltage rising into regulation

Set-up Example – Dual (+/-) Output Using Scope

A scope probes can be connected at the input or output test points to observe dynamic performance such as start-up or transient response.

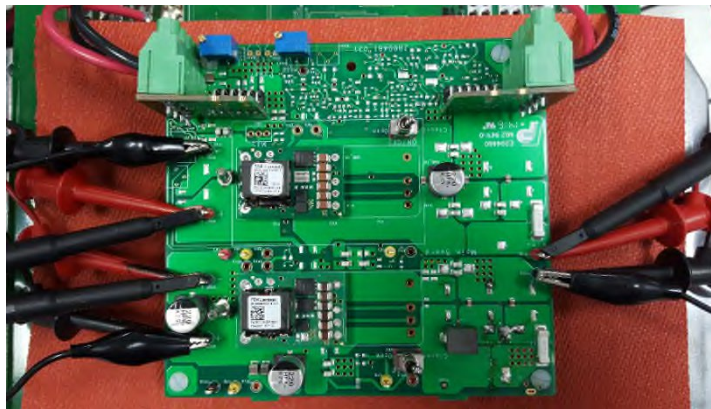

Be aware that the loop formed by the scope probe's ground lead may pick up spurious switching noise.

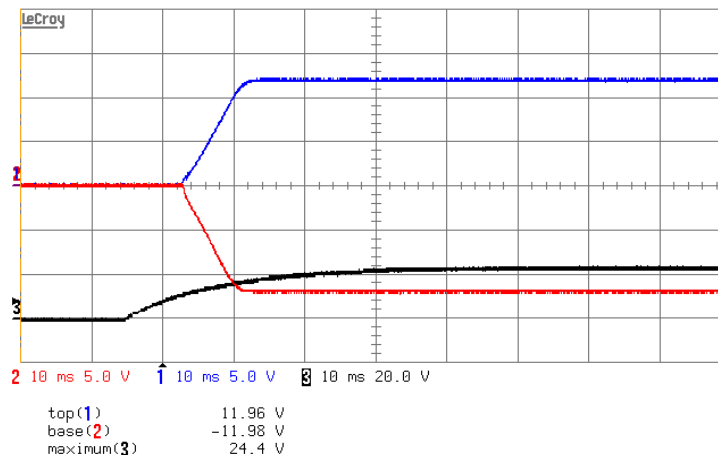

Black - application of input voltage
 Blue - positive output voltage
 Red - negative output voltage

NORMAL

Set-up Example – Using Scope

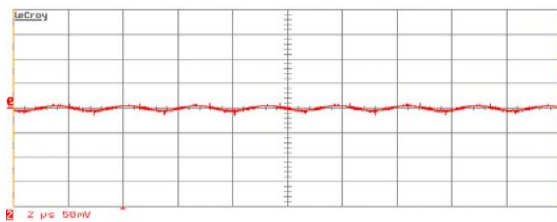
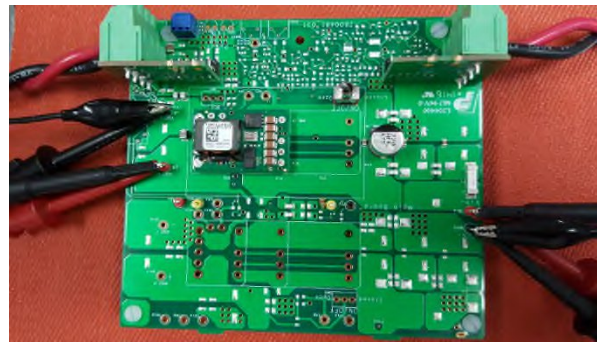
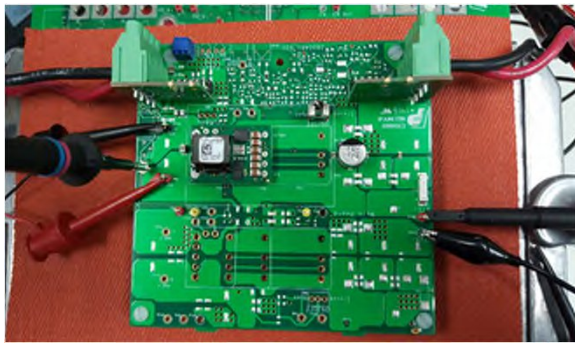

AUTO

Full load output ripple with scope socket

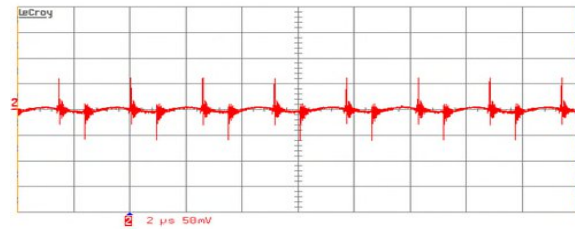

AUTO

Full load output ripple with ground loop acting as an antenna

Schematic – Single Output (positive)

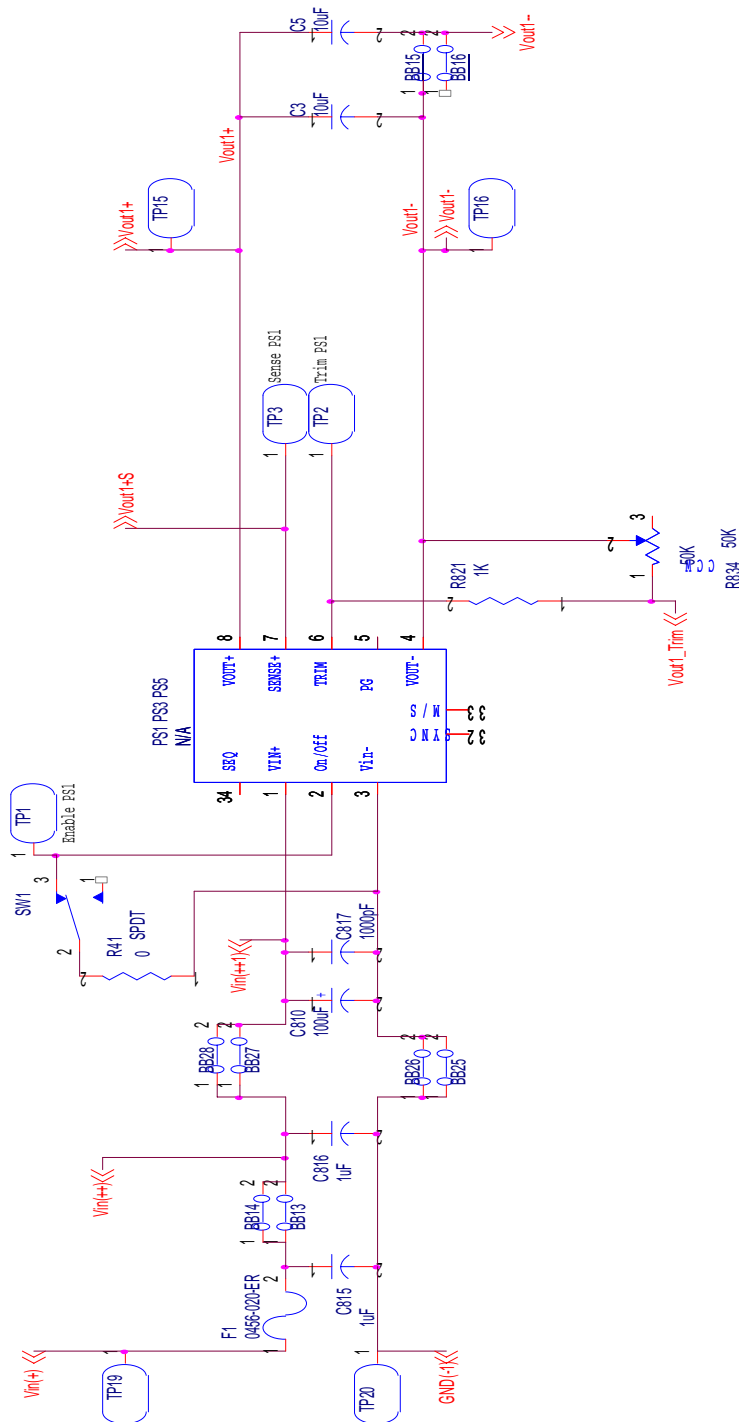

Schematic – Dual (+/-) Output (pos. & neg.)

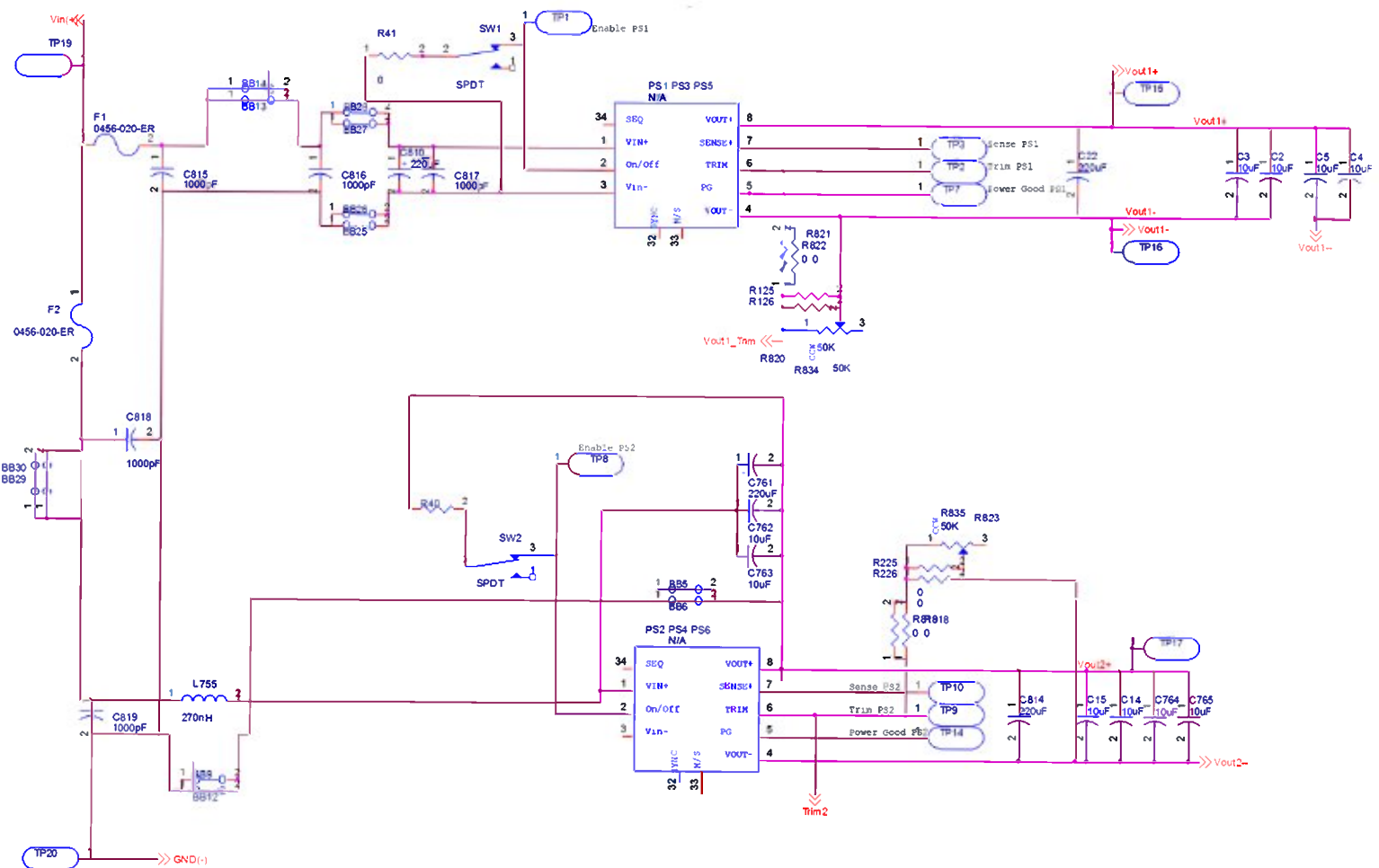

BOM – Single Output

I6A20A-001-EVK-S1PX				I6A14A-001-EVK-S1PX			
Mfr. Name	Mfr. Part Number	Description	Ref Des	Mfr. Name	Mfr. Part Number	Description	Ref Des
TDK	C3225X7S1H106MT	CERAMIC CAPACITOR, 50V, 1210, 10uF, X7S	C5	TDK	C3225X7S1H106MT	CERAMIC CAPACITOR, 50V, 1210, 10uF, X7S	C5
TDK	C3225X7S1H106MT	CERAMIC CAPACITOR, 50V, 1210, 10uF, X7S	C3	TDK	C3225X7S1H106MT	CERAMIC CAPACITOR, 50V, 1210, 10uF, X7S	C3
PANASONIC	EEEFK1J101P	CAP, 100UF, 63V, SMT	C810	PANASONIC	EEEFK1H221P	CAP, 220UF, 50V, SMT	C810
TDK	C2012X7S2A105K125AB	CERAMIC CAPACITOR, 100V, 0805, 1uF	C815	TDK	C2012X7R1H225K125AC	CERAMIC CAPACITOR, 50V, 0805, 2.2uF	C815
TDK	C2012X7S2A105K125AB	CERAMIC CAPACITOR, 100V, 0805, 1uF	C817	TDK	C2012X7R1H225K125AC	CERAMIC CAPACITOR, 50V, 0805, 2.2uF	C817
TDK	C2012X7S2A105K125AB	CERAMIC CAPACITOR, 100V, 0805, 1uF	C816	TDK	C2012X7R1H225K125AC	CERAMIC CAPACITOR, 50V, 0805, 2.2uF	C816
LITTLEFUSE	0456025.ER	25A SMT Fuse	F1	LITTLEFUSE	0456025.ER	25A SMT Fuse	F1
Power Unit Assembly	I6A4W020A033V-001-R	DCDC Power Module	PS1	Power Unit Assembly	I6A24014A033V-001-R	DCDC Power Module	PS1

BOM – Dual (+/-) Output (pos. & neg.)

Mfr. Name	Mfr. Part Number	Description	Ref Des
I6A14A-001-EVK-D2PN			
TDK	C3225X7S1H106MT	CERAMIC CAPACITOR, 50V, 1210, 10uF, X7S	C5
TDK	C3225X7S1H106MT	CERAMIC CAPACITOR, 50V, 1210, 10uF, X7S	C3
TDK	C3225X7S1H106MT	CERAMIC CAPACITOR, 50V, 1210, 10uF, X7S	C14
TDK	C3225X7S1H106MT	CERAMIC CAPACITOR, 50V, 1210, 10uF, X7S	C762
TDK	C3225X7S1H106MT	CERAMIC CAPACITOR, 50V, 1210, 10uF, X7S	C763
PANASONIC	EEEFK1H221P	CAP, 220UF, 50V, SMT	C810
PANASONIC	EEEFK1H221P	CAP, 220UF, 50V, SMT	C814
PANASONIC	EEEFK1H221P	CAP, 220UF, 50V, SMT	C761
TDK	C2012X7R1H225K125AC	CERAMIC CAPACITOR, 50V, 0805, 2.2uF	C815
TDK	C2012X7R1H225K125AC	CERAMIC CAPACITOR, 50V, 0805, 2.2uF	C817
TDK	C2012X7R1H225K125AC	CERAMIC CAPACITOR, 50V, 0805, 2.2uF	C816
TDK	C2012X7R1H225K125AC	CERAMIC CAPACITOR, 50V, 0805, 2.2uF	C818
TDK	C2012X7R1H225K125AC	CERAMIC CAPACITOR, 50V, 0805, 2.2uF	C819
LITTLEFUSE	0456025.ER	25A SMT Fuse	F1
LITTLEFUSE	0456025.ER	25A SMT Fuse	F2
Power Unit Assembly	I6A24014A033V-001-R	DCDC Power Module	PS1
Power Unit Assembly	I6A24008A033V-N01-R	DCDC Power Module	PS2