

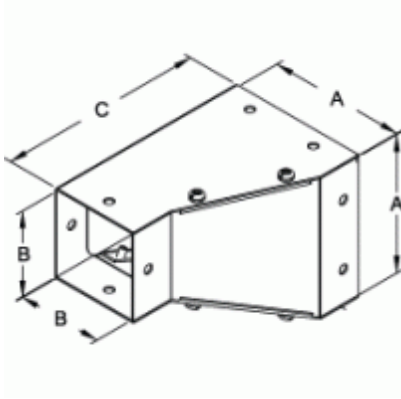

Quality Products. Service Excellence.

Corner Reducer *CWCRD Series*



Part No.	Size
CWCRD42	4x4 to 2.5x2.5
CWCRD64	6x6 to 4x4
CWCRD86	8x8 to 6x6

Data subject to change without notice



© 2023. Hammond Manufacturing Ltd. All rights reserved.