

THIS DOCUMENT IS THE PROPERTY OF
KEYSTONE ELECTRONICS CORP. AND
SHALL NOT BE REPRODUCED, DISTRIBUTED
OR USED AS A BASIS FOR MANUFACTURE
WITHOUT PRIOR WRITTEN PERMISSION
FROM KEYSTONE ELECTRONICS CORP.

ACTUAL SIZE

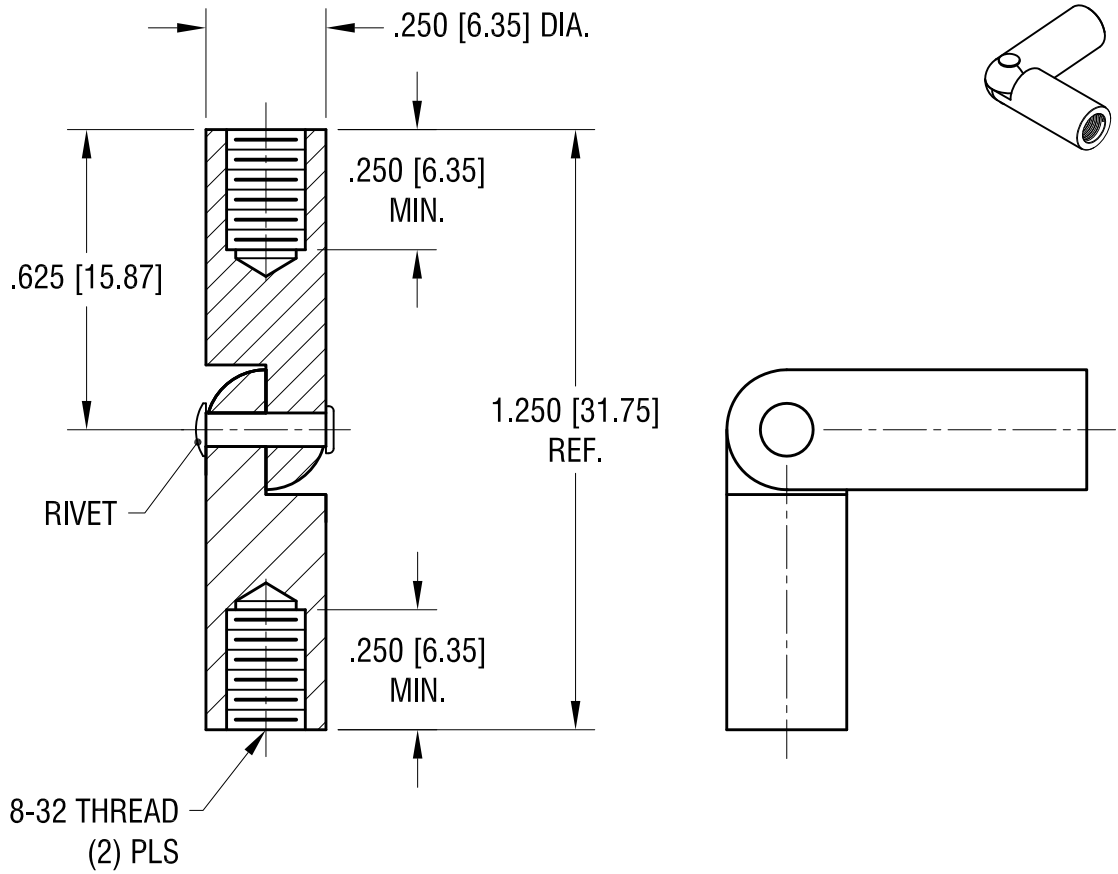

2.03.23	ECN23-013, PLATING WAS ZINC TRIVALENT YELLOW CHROMATE	B
9.08.08	CHANGED AS PER ECN 08-148	A
DATE	DESCRIPTION	REV.

KEYSTONE ELECTRONICS CORP.			
www.keyelco.com • NEW HYDE PARK NY 11040 • Tel (516)328-7500			
PART NAME			
HINGED STANDOFF, FEMALE / FEMALE			
MATERIAL			
BRASS			
FINISH		DRN BY	DATE
BRIGHT BRASS		BOONE	9.18.95
		APP'D	SCALE
		RH	2.5X
TOLERANCES	INCH [MM]	CODE	DWG NO.
DECIMAL	± .005 [± 0.13]	C	332
ANGULAR	± 1°		
UNLESS OTHERWISE SPECIFIED			