

NOTES:

1. Material : Music Wire
2. Finish : Glod Irridite
3. Ends : Closed
4. Total Coils : 10.000
5. Sugg. Max. Deflection : 1.400 (in)
6. Sugg. Max. Load : 2.300 (lbs)
7. All Drawing Dimensions are in Inches [mm]

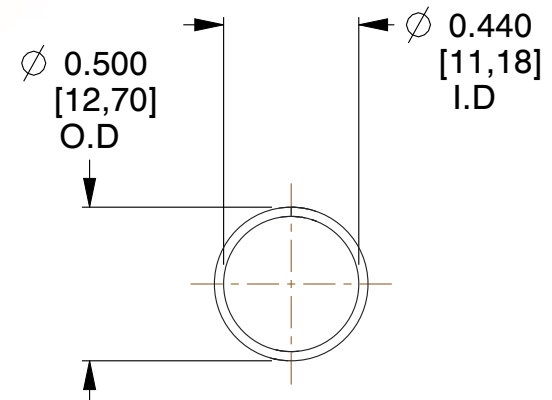
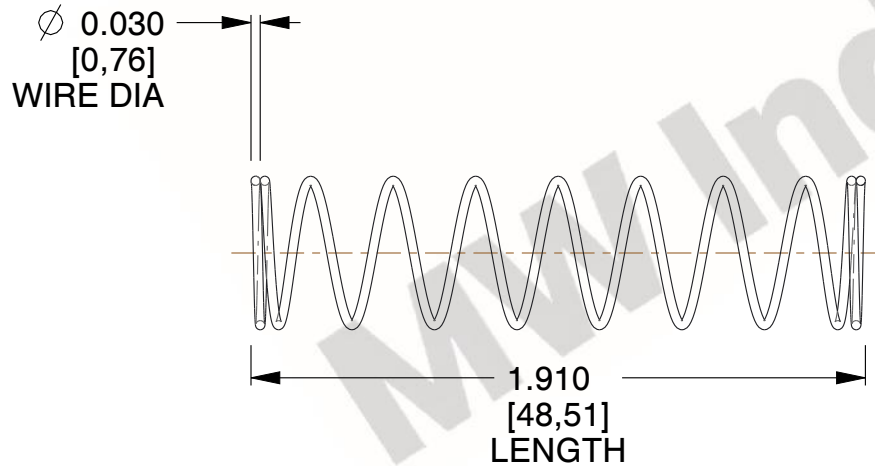

| COMPONENT | | SPRINGS | |
|---------------------|--|-----------|--|
| 11772 | | UNIT | |
| | | INCH [mm] | |
| | | SHEET | |
| COMPRESSION SPRINGS | | 1 of 1 | |