

Build Your Own Clone Divided Octave Kit Instructions

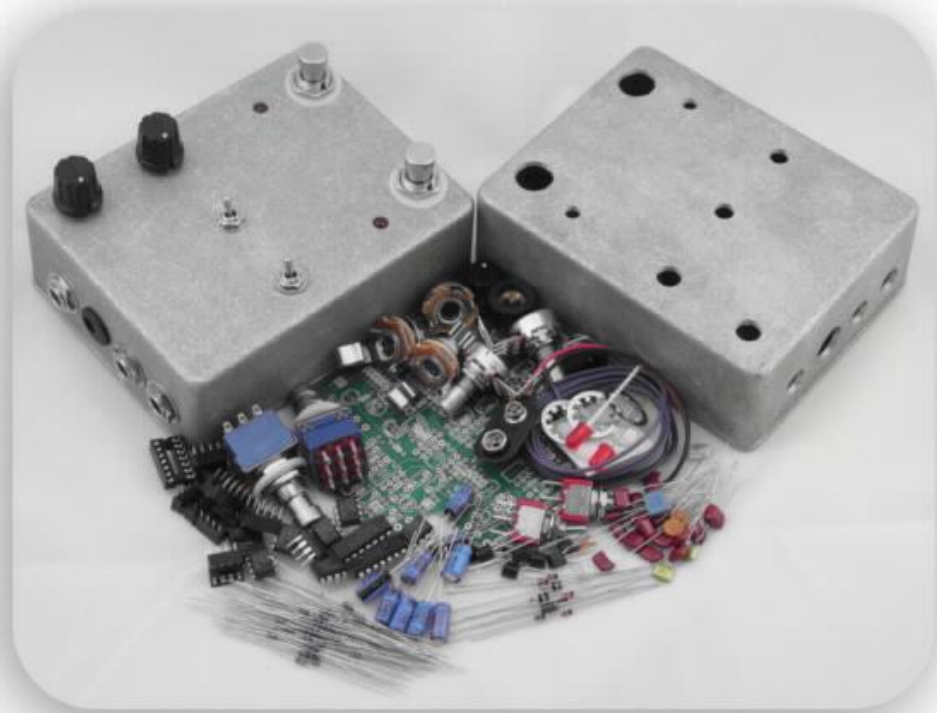

Warranty:

BYOC, Inc. guarantees that your kit will be complete and that all parts and components will arrive as described, functioning and free of defect. Soldering, clipping, cutting, stripping, or using any of the components in any way voids this guarantee. BYOC, Inc. guarantees that the instructions for your kit will be free of any major errors that would cause you to permanently damage any components in your kit, but does not guarantee that the instructions will be free of typos or minor errors. BYOC, Inc. does not warranty the completed pedal as a whole functioning unit nor do we warranty any of the individual parts once they have been used. If you have a component that is used, but feel it was defective prior to you using it, we reserve the right to determine whether or not the component was faulty upon arrival. Please direct all warranty issues to: sales@buildyourownclone.com This would include any missing parts issues.

Return:

BYOC, Inc. accepts returns and exchanges on all products for any reason, as long as they are unused. We do not accept partial kit returns. Returns and exchanges are for the full purchase price less the cost of shipping and/or any promotional pricing. Return shipping is the customer's responsibility. This responsibility not only includes the cost of

shipping, but accountability of deliver as well. Please contact sales@buildyourownclone.com to receive a return authorization before mailing.

Tech Support:

BYOC, Inc. makes no promises or guarantees that you will successfully complete your kit in a satisfactory manner. Nor does BYOC, Inc. promise or guarantee that you will receive any technical support. Purchasing a product from BYOC, Inc. does not entitle you to any amount of technical support. BYOC, Inc. does not promise or guarantee that any technical support you may receive will be able to resolve any or all issues you may be experiencing.

That being said, we will do our best to help you as much as we can. Our philosophy at BYOC is that we will help you only as much as you are willing to help yourself. We have a wonderful and friendly DIY discussion forum with an entire section devoted to the technical support and modifications of BYOC kits.

www.buildyourownclone.com/board

When posting a tech support thread on the BYOC forum, please post it in the correct lounge, and please title your thread appropriately. If everyone titles their threads "HELP!", then it makes it impossible for the people who are helping you to keep track of your progress. A very brief description of your specific problem will do. It will also make it easier to see if someone else is having or has had the same problem as you. The question you are about to ask may already be answered. Here are a list of things that you should include in the body of your tech support thread:

1. A detailed explanation of what the problem is. (not just, "It doesn't work, help")
2. Pic of the top side of your PCB.
3. Pic of the underside of your PCB.
4. Pic that clearly shows your footswitch/jack wiring and the wires going to the PCB
5. A pic that clearly shows your wiring going from the PCB to the pots and any other switches(only if your kit has non-PC mounted pots and switches)
6. Is bypass working?
7. Does the LED come on?
8. If you answer yes to 6 and 7, what does the pedal do when it is "on"?
9. Battery or adapter.(if battery, is it good? If adapter, what type?)

Also, please only post pics that are in focus. You're only wasting both parties' time if you post out of focus, low res pics from your cell phone.

Revision Notes:

Rev 1.0 There are no known errors.

Copyrights:

All material in this document is copyrighted 2011 by BYOC, Inc.

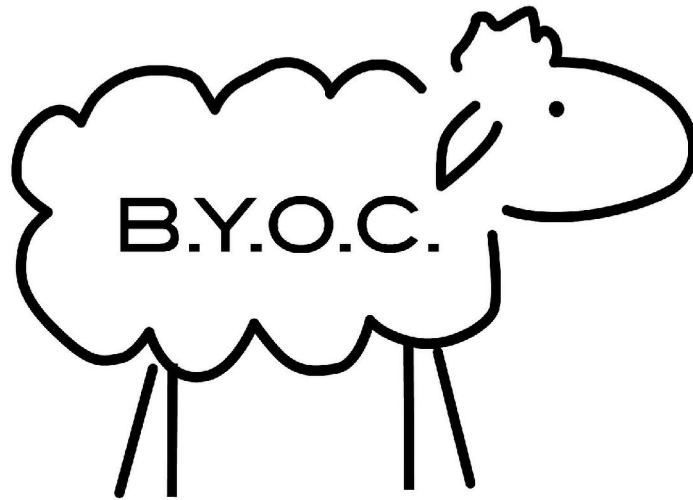

WWW.BUILDYOUROWNCLONE.COM

DIVIDED OCTAVE KIT INSTRUCTION INDEX

Parts Checklist.....	page 4 - 6
Populating the Circuit Board.....	page 7 - 14
Main PCB Assembly.....	page 15 - 18
Wiring.....	page 19 - 22
Installing the IC's.....	page 23
Operation Overview.....	page 24
Schematic.....	page 25 - 26

Parts Checklist for BYOC Divided Octave Kit

Resistors:

- 1 - 560ohm/561 (green/blue/black/black/brown)
- 1 - 1k/102 (brown/black/black/brown/brown)
- 4 - 2k2/222 (red/red/black/brown/brown)
- 1 - 3k3/332 (orange/orange/black/brown/brown)
- 7 - 4k7 /472 (yellow/purple/black/brown/brown)
- 1 - 5k6/562 (green/blue/black/brown/brown)
- 1 - 6k8/682 (blue/gray/black/brown/brown)
- 3 - 10k/103 (brown/black/black/red/brown)
- 1 - 12k/123 (brown/red/black/red/brown)
- 6 - 15k/153 (brown/green/black/red/brown)
- 5 - 22k/223 (red/red/black/red/brown)
- 1 - 27k/273 (red/purple/black/red/brown)
- 1 - 33k/333 (orange/orange/black/red/brown)
- 3 - 47k/473 (yellow/purple/black/red/brown)
- 2 - 51.1k/513 (green/brown/brown/red/brown)
- 2 - 56k/563 (green/blue/black/red/brown) or (green/blue/orange/gold)
- 1 - 68k/683 (blue/gray/black/red/brown)
- 1 - 82k/823 (gray/red/black/red/brown)
- 6 - 100k/104 (brown/black/black/orange/brown)
- 1 - 130k/134 (brown/orange/black/orange/brown)
- 3 - 180k/184 (brown/gray/black/orange/brown)
- 8 - 220k/224 (red/red/black/orange/brown)
- 3 - 390k/394 (orange/white/black/orange/brown)
- 2 - 470k/474 (yellow/purple/black/orange/brown)

Capacitors:

- 1 - 20pf (small round orange, may have 200 printed on it)
- 1 - 33pf (small round orange, may have 330 printed on it)
- 1 - 390pf (small round orange, may have 391 printed on it)
- 2 - 820pf (small round orange, may have 821 printed on it)
- 1 - 1n0/.001uf (may have 102 printed on it)
- 2 - 2n2/.002uf (may have 222 printed on it)
- 1 - 6n8/.0068uf (may have 682 printed on it)
- 2 - 10n or .01 μ film (may have 103 printed on it)
- 1 - 15n/.015uf (may have 153 printed on it)
- 1 - 22n/.022uf (may have 223 printed on it)
- 2 - 33n/.033uf (may have 333 printed on it)
- 3 - 47n/.047uf (may have 473 printed on it)
- 4 - 100n/.1uf (may have 104 printed on it)

- 1 - 150n/.15uf (may have 154)printed on it)
- 2 - 220n/.22uf (may have 224 printed on it)
- 2 - 470n/.47uf (may have 474 printed on it)
- 3 - 1 μ aluminum electrolytic
- 1 - 4.7 μ f aluminum electrolytic
- 2 - 10 μ f aluminum electrolytic
- 2 - 47 μ f aluminum electrolytic
- 1 - 100 μ f aluminum electrolytic

Diodes:

- 2 - 1N60 (clear glass germanium)
- 7 - 1N4148 (small orange glass)
- 1 - 1N4001 (black plastic)

Transistors:

- 5 - 2N3904
- 1 - 2N3906
- 1 - 2N5088
- 1 - 2N5457
- 1 - BS170

IC's

- 7 - 8 pin sockets
- 2 - 14 pin sockets
- 1 - MAX1044
- 1 - 4011
- 1 - 4013
- 6 - 4558

Potentiometers: Be sure to snap off the small tab on the side of each panel mounted pot.

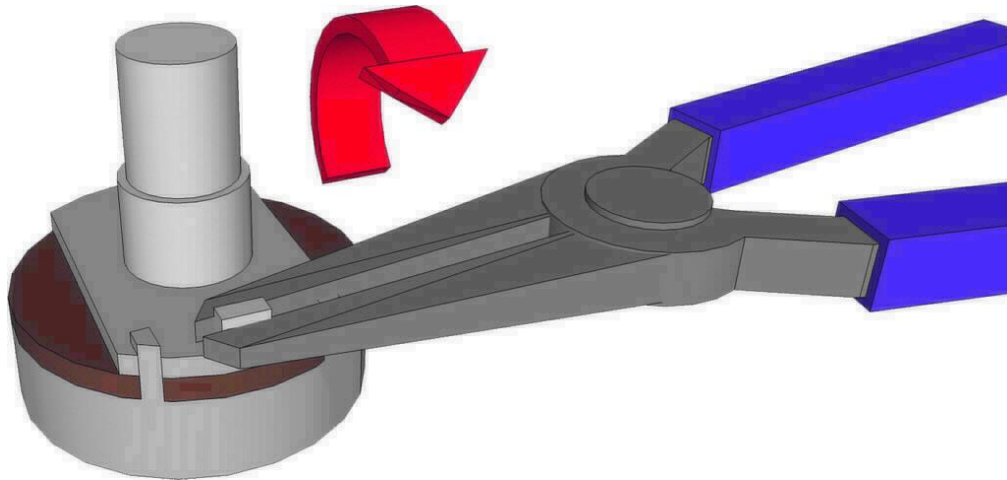

- 1 - B10k linear (TONE)
- 1 - B50k audio (MIX)

Hardware:

- 1 - drilled enclosure w/ 4 screws
- 1 - byoc classic Divided Octave PCB
- 2 - SPDT ON-ON toggle switch
- 2 - 3PDT footswitch
- 2 - knobs
- 1 - AC adaptor jack
- 3 - 1/4" mono jack
- 2 - red LED
- 4 - bumpers
- hook-up wire

Populating the Circuit Board

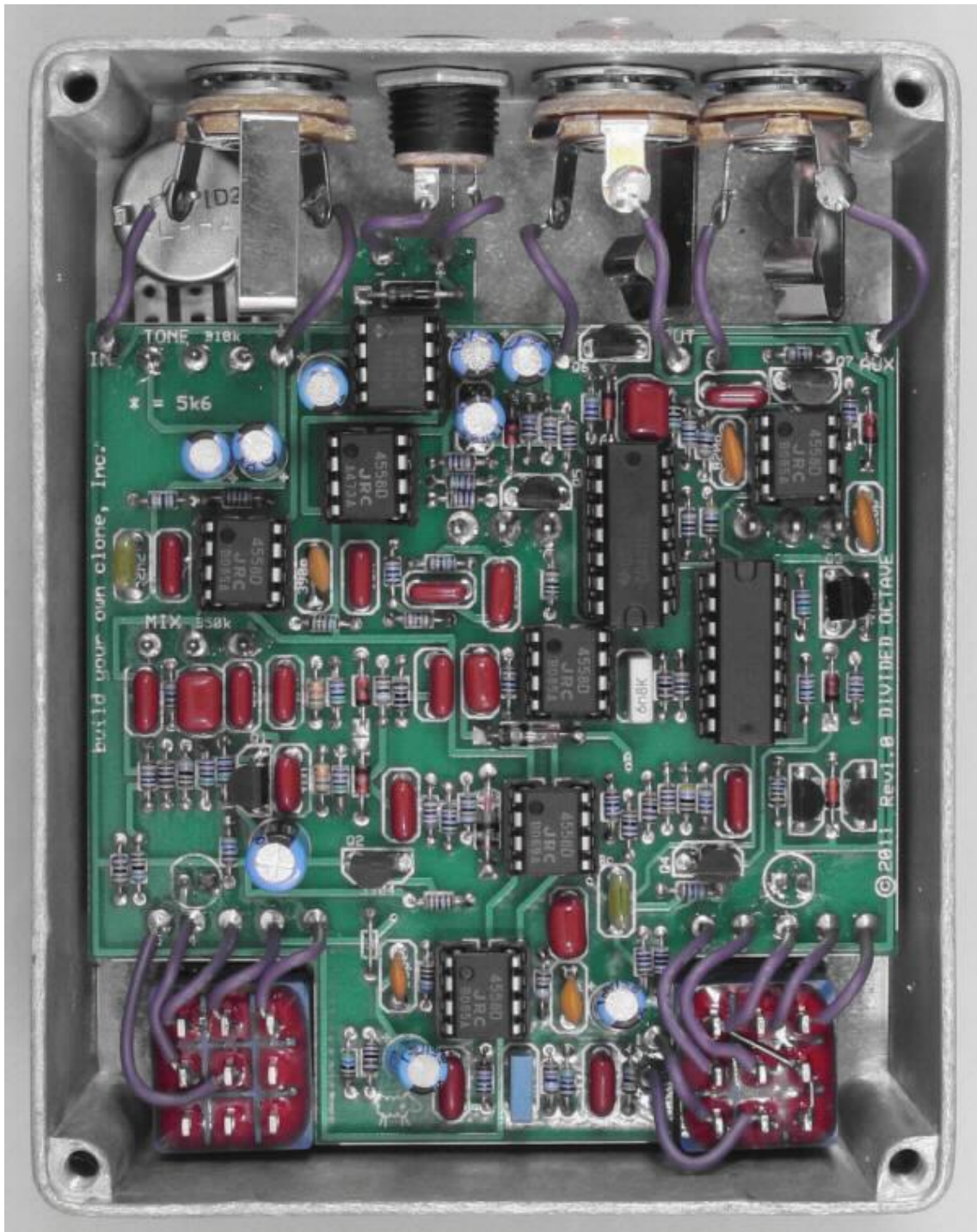

for a larger pic, go to www.buildyourownclone.com/dividedoctaveguts.jpg

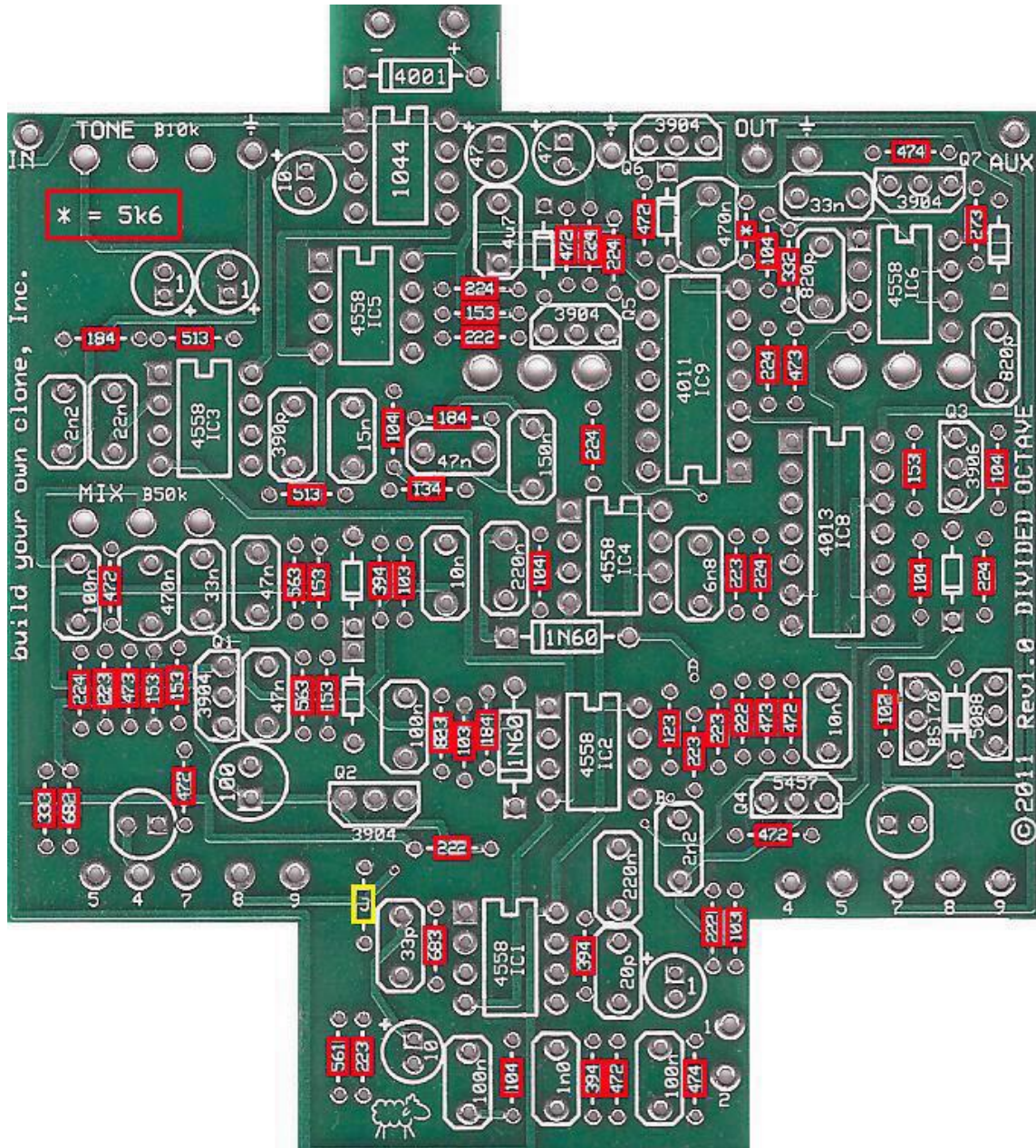

STEP 1: Add the resistors . Resistors are not polarized, so it does not matter which end goes in which solder pad. Take your time and be sure not to confuse similarly banded resistors such as the 470k with the 4k7 or the 22k with the 2k2. If you have difficulty reading the color bands, use a digital multimeter to test the value of each resistor.

Note1: The resistor space marked with "*" is a 5.6k.

Note2: The resistor space marked with "J" is a jumper. After you've added all the resistors and clipped the excess lead, use a piece of the excess lead to make a jumper from one eyelet to the other.

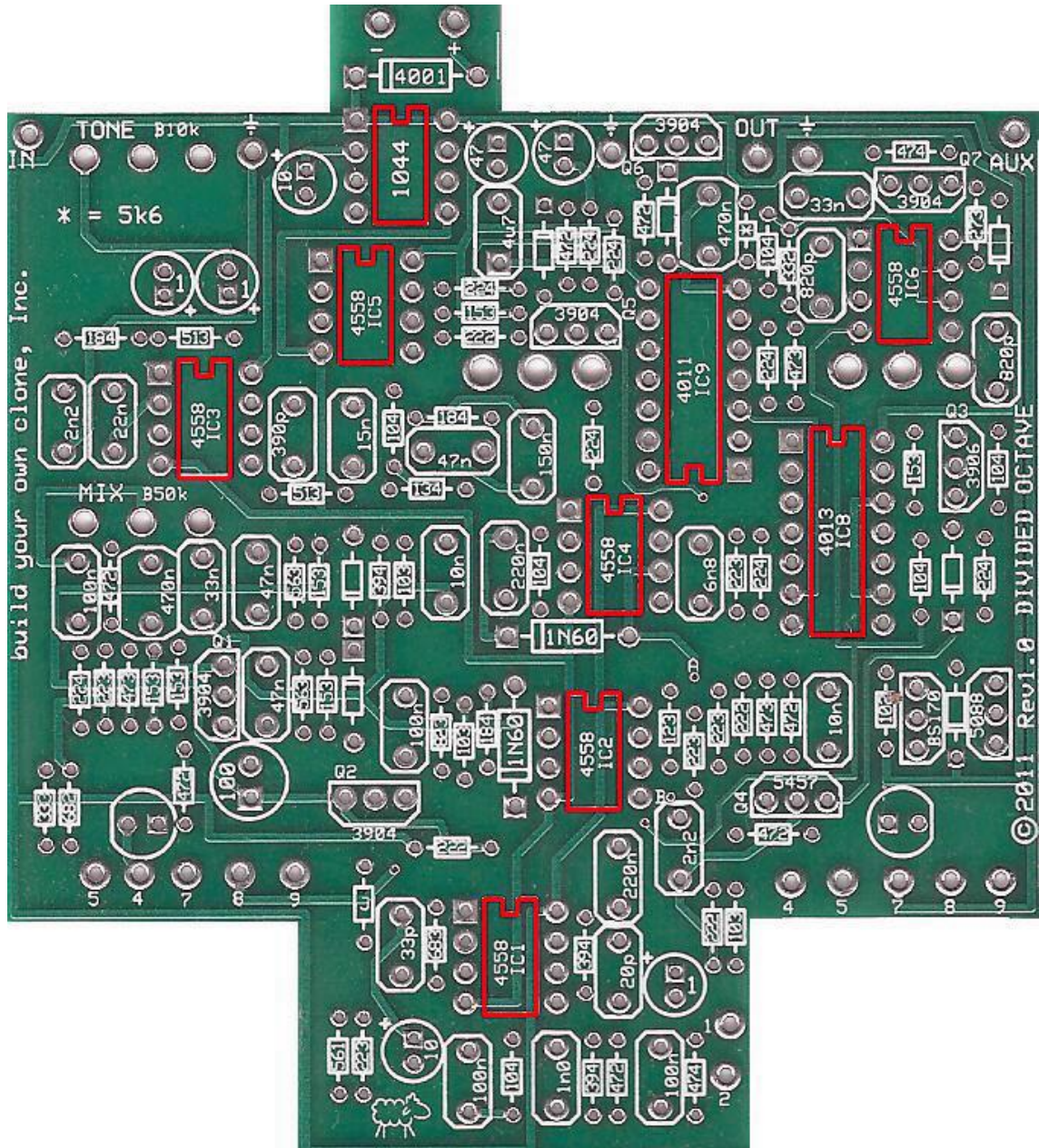

Step 3: Add the IC sockets. Just the sockets!!!! Do not add or solder the actual ICs themselves yet. The ICs never get soldered. Only the sockets get soldered. You will install the actual ICs at the very end of this build.

The sockets have a U-shaped notch on one end. Match this notch up with the notch silkscreen on the PCB layout.

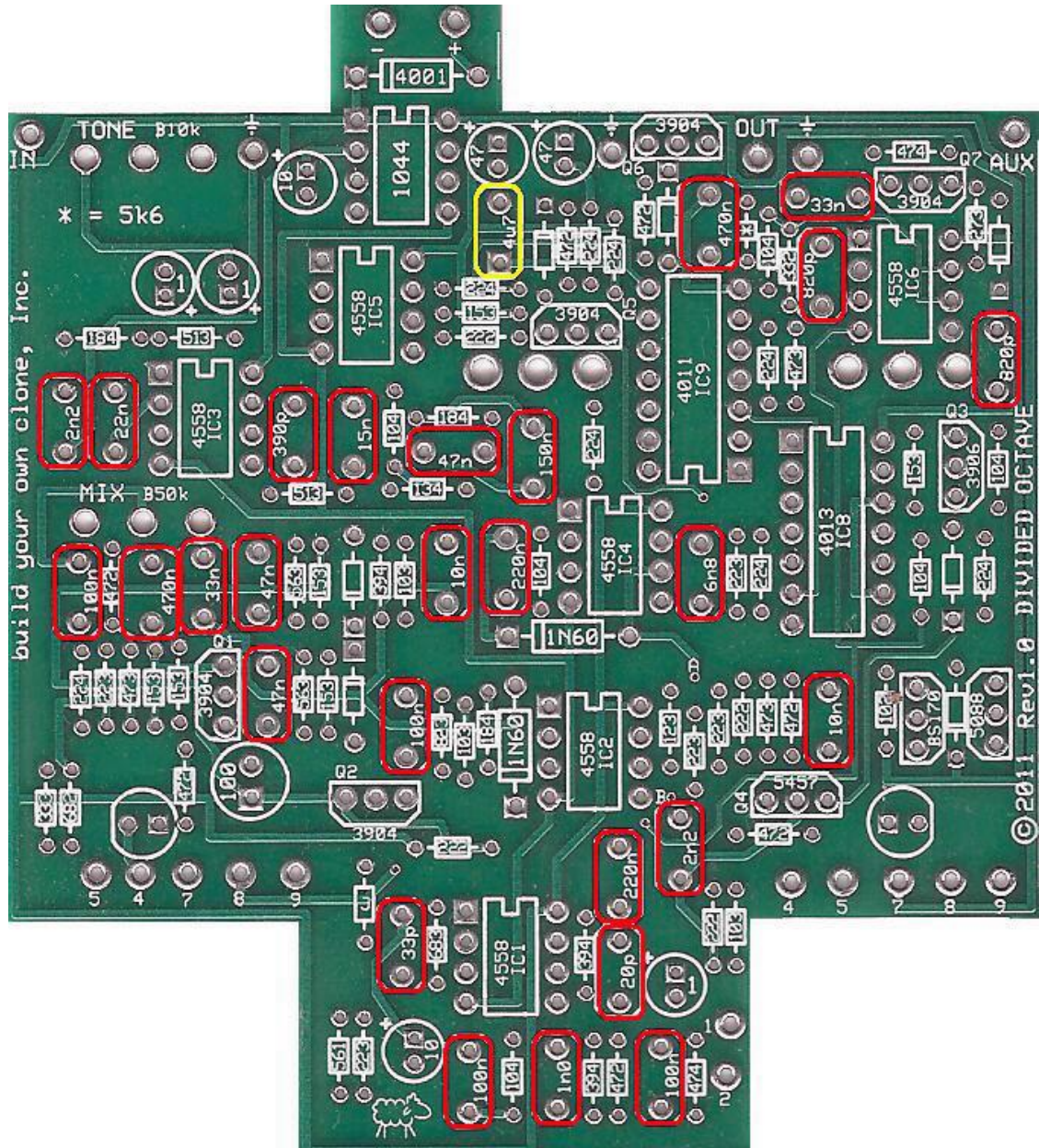

Step 4: Add the film capacitor. These are not polarized and can be inserted into the PCB either way.

Note: The 4.7uF capacitor highlighted in yellow is not a film cap and should not be added at this time. It is an electrolytic cap and will be added when you add the other electrolytic caps.

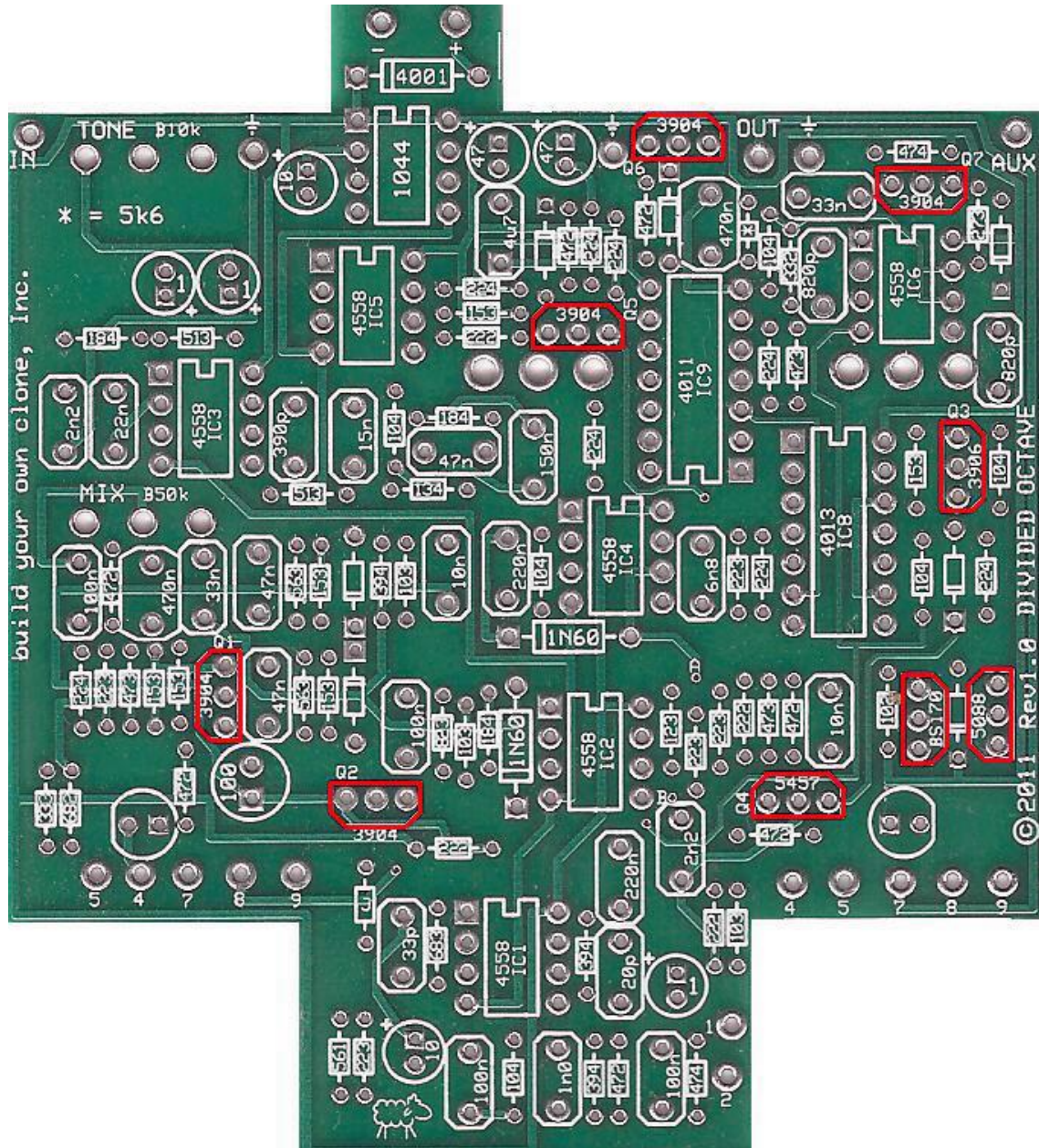

Step 5: Add the Transistors. Orient the transistors so that the flat side of the transistor body matches up with the flat side on the PCB layout. There are 5 different transistors in this build and it is very important that they each go in their correct place. Be sure to take the time to differentiate the different transistors.

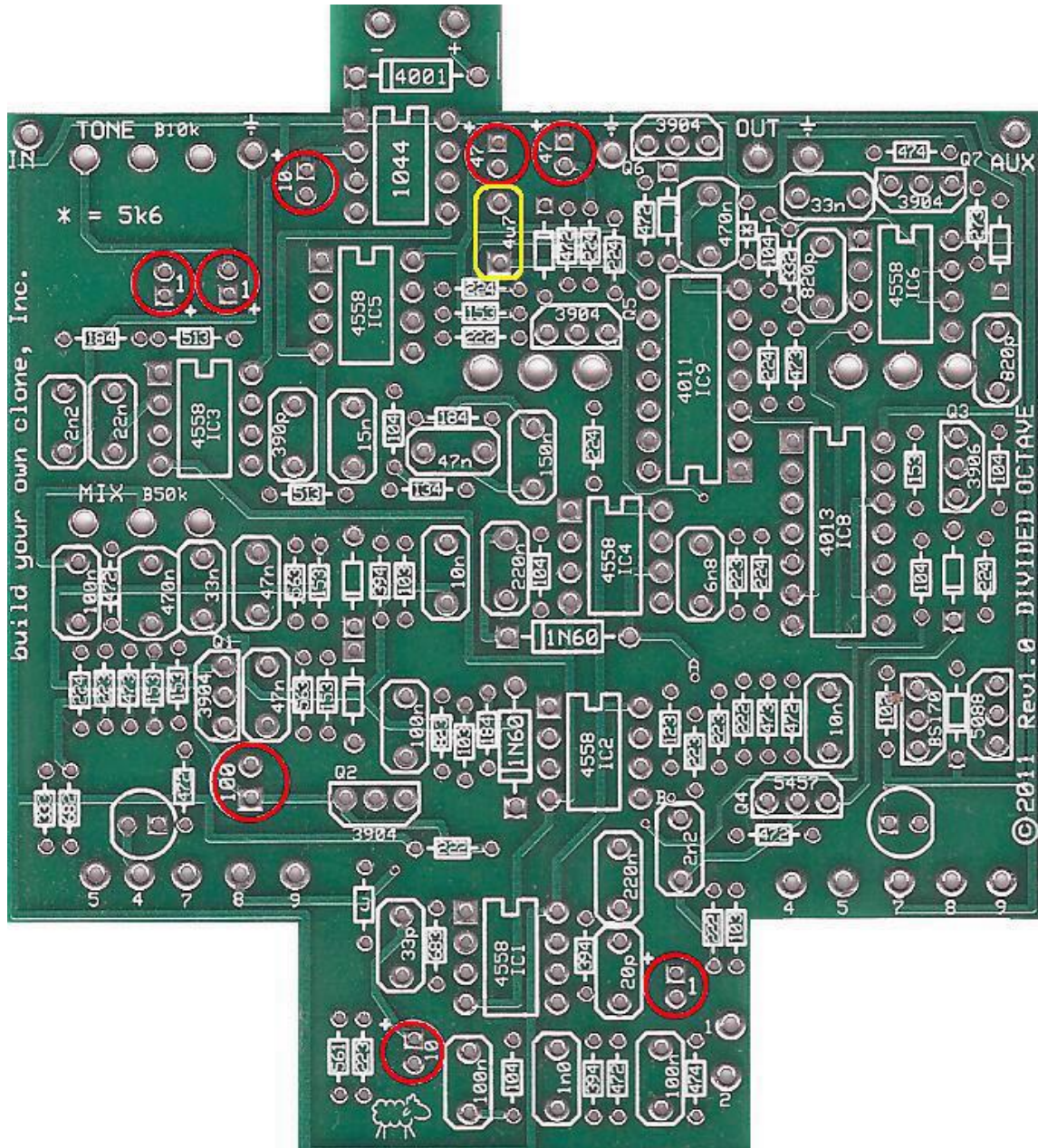

STEP 6: Add the aluminum electrolytic capacitors. These are polarized. The positive end will have a longer lead and should go in the square solder pad. The negative end will have a shorter lead with a black or white stripe running down the body of the capacitor.

Note: The space for the 4.7uF capacitor (highlighted in yellow) is not round, but should be treated just the same as the other electrolytic caps. The longer lead goes in the square solder pad.

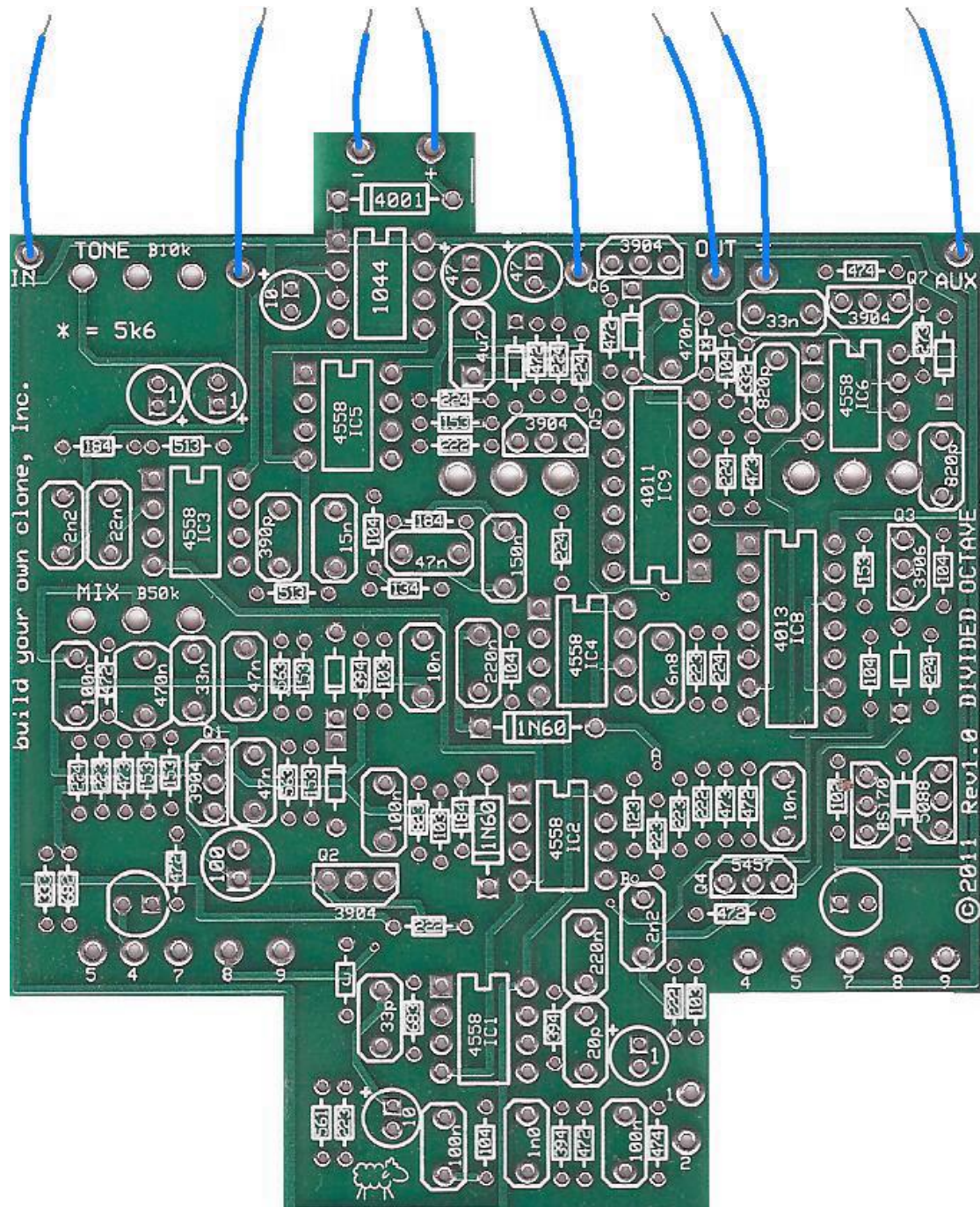

Step 7: Add wires to the IN, OUT, AUX, "+", "-", and three Ground eyelets. Start by cutting six 2.5" pieces of wire and two 1.5" piece of wire. Strip 1/4" off each end and tin the ends. Tinning means to apply some solder to the stripped ends of the wires. This keeps the strands from fraying and primes the wire for soldering. Solder a 2.5" piece of wire to each of the IN, OUT, AUX, and Ground eyelets on the PCB. Solder a 1.5" piece of wire to each of the "+" and "-" eyelets on the PCB. Load the wires in from the top and solder on the bottom of the PCB.

Main PCB Assembly

Below is a picture of an “internal nut” DC adapter jack with nylon nut. Your kit may come with a jack that looks like this, or it may come with an “external nut” jack with metal nut. Both have the exact same termination and both function identically. Internal nut jacks mount to the enclosure from the outside and the nut goes on the inside. External nut jacks mount from the inside and the nut goes on the outside.

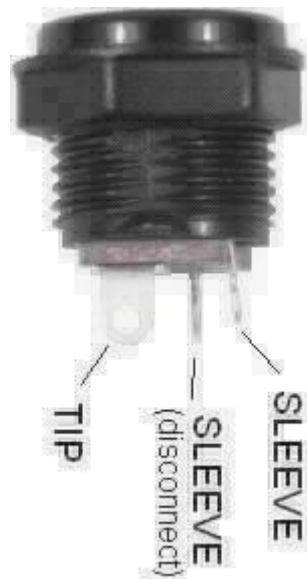

Step 1: Mount the DC adapter jack to the enclosure.

The sleeve disconnect terminal of the DC adapter jack connects directly to the positive terminal of the battery via the PCB. The sleeve disconnect terminal is connected to the sleeve terminal when there is no DC adapter plugged into the jack. When a DC adapter jack is plugged into the DC adapter jack, the connection between the sleeve disconnect terminal and the sleeve terminal is broken, thus disconnecting the battery from the circuit when a DC power supply is in use. This allows you to safely keep a battery in your pedal and still use a DC power supply.

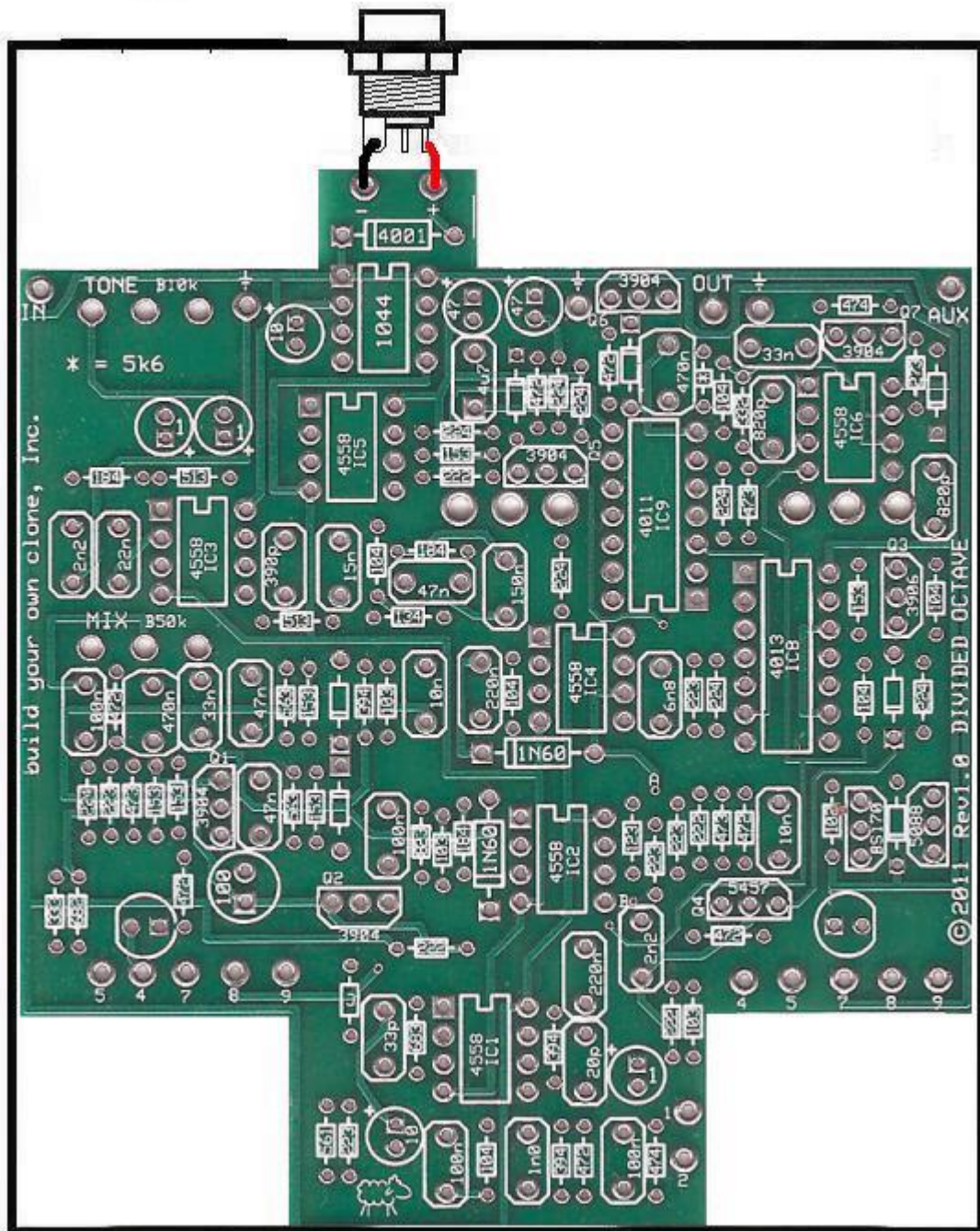

Step 2: Connect the TIP (negative) terminal of the DC adapter jack to the “-” eyelet on the PCB with 2 inches of hook up wire. Connect the SLEEVE of the DC adaptor jack to the “+” eyelet on the far right side of the PCB with 2 inches of hook up wire. Connect the battery disconnect terminal of the DC adaptor jack to the “+” eyelet more towards the center of the PCB with 2” of hookup wire. Load the wires in from the bottom of the PCB and solder on the topside.

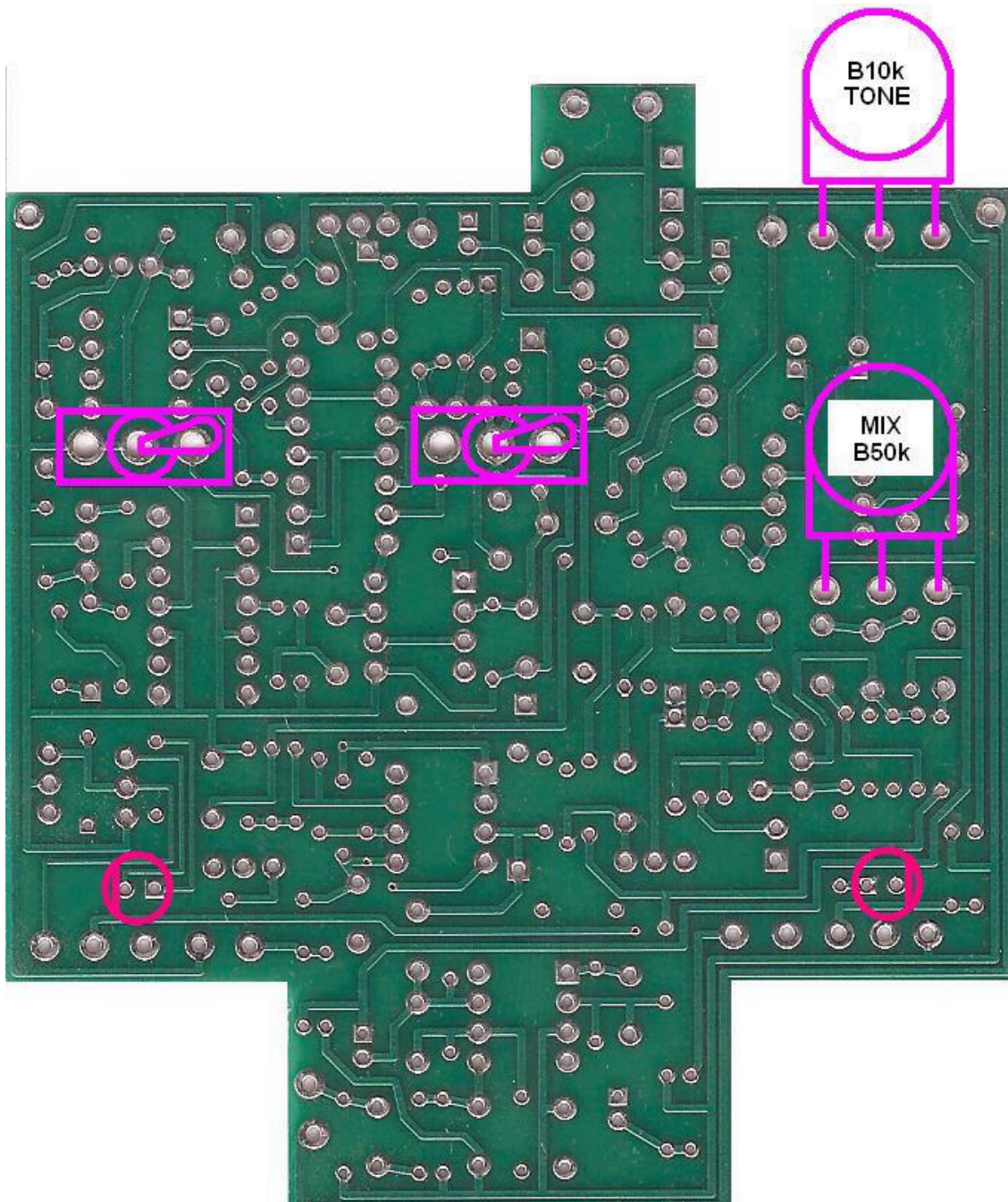

Step 3: Flip the PCB over so that the bottom or solder side is up. Insert the B10k(TONE), B50k(MIX) potentiometers, the two SPDT Toggle Switches, and the two LEDs into the bottom side of the PCB. **DO NOT SOLDER ANYTHING YET!!!**

The LEDs will have one lead that is longer than the other. The longer lead goes in the hole with the square solder pad. It is very important that you orient the LEDs correctly, otherwise, they will not light up.

Step 4: Hold the PCB in one hand so that the component side of the PCB is in the palm of your hand and the bottom side with the pots, toggle switch and LED is facing up. Now use your other hand to guide the predrilled enclosure onto the PCB assembly so that the

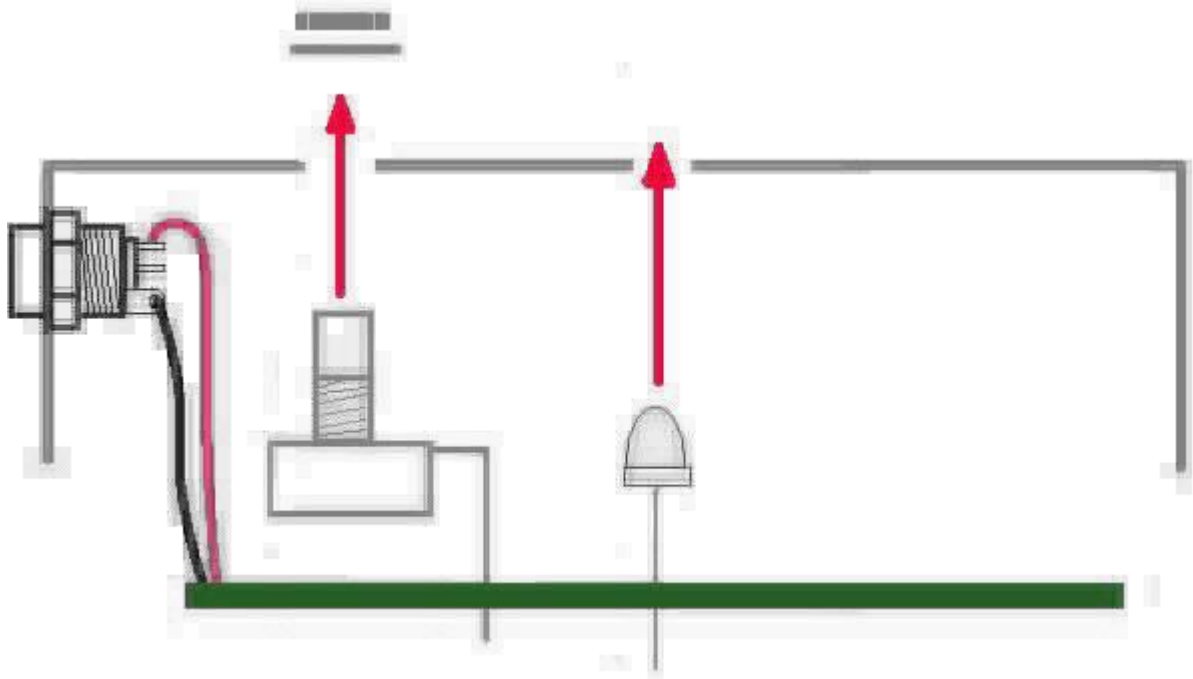

pots and LED all go into their respective holes. Once the PCB assembly is in place, secure it by screwing on the washers and nuts for the pots and toggle switch. Only tighten them with your fingers. You do not want them very tight yet. Be sure to keep your hand on the PCB so that it does not fall off the PC mounting posts of the pots and toggle switch.

Step 5: Turn the entire pedal over so that the component side of the PCB if facing up. Lift the PCB up off the pots and toggle switch about 2mm just to make sure that the back of the PCB does not short out against that pots. Make sure the PCB is level and symetrically seated inside the enclosure.

Step 6: Solder the pots and LEDs. You will solder these parts on the component side of the PCB. After you have soldered them in place, be sure to tighten up their nuts.

Wiring



Step 1: Install the 1/4" jacks to the enclosure. The Divided Octave only uses mono jacks. Be sure to install the jacks so that the prong of the IN JACK is at 12 o'clock and the prongs of the OUT and AUX JACKS are both at 4 o'clock.

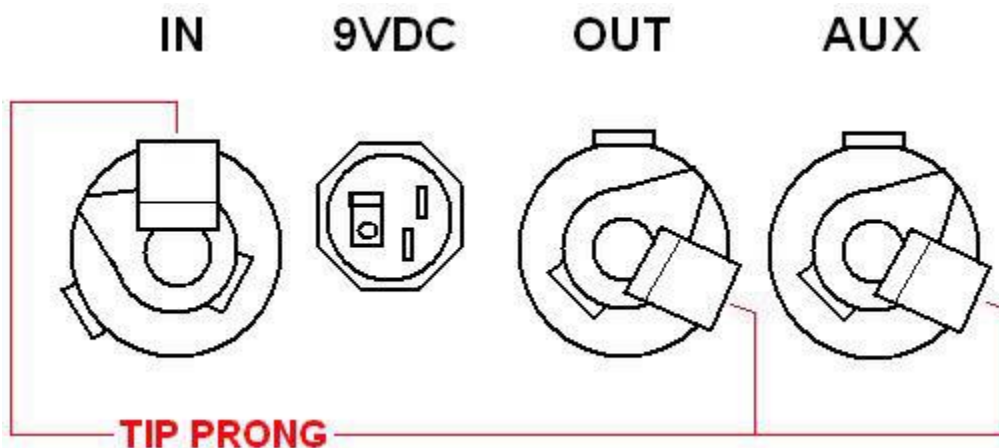

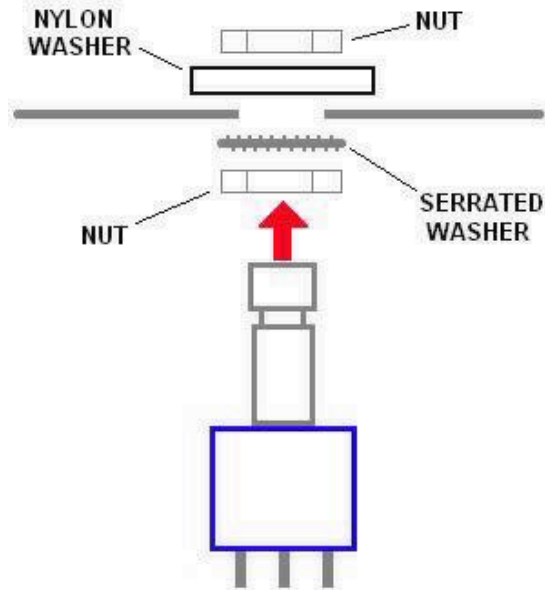

Step 2: Install the footswitch. Orient the footswitch so that the flat sides of the solder lugs are like the diagram below. NOTE: There are no actual number markings on the footswitch. There are two correct ways you can orient the footswitch. They are both 180 degrees of each other. Either way is fine. It does not matter as long as the flat sides of the solder lugs are running vertical, not horizontal. Yes, this is different from all other BYOC kits, but the number designators are still exactly the same

FOOT SWITCH SOLDER LUG DESIGNATIONS

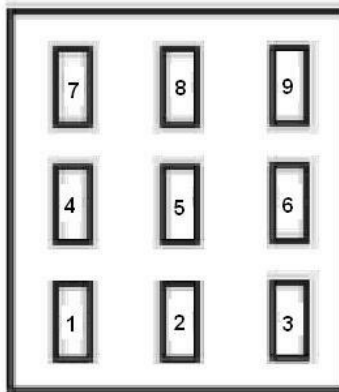

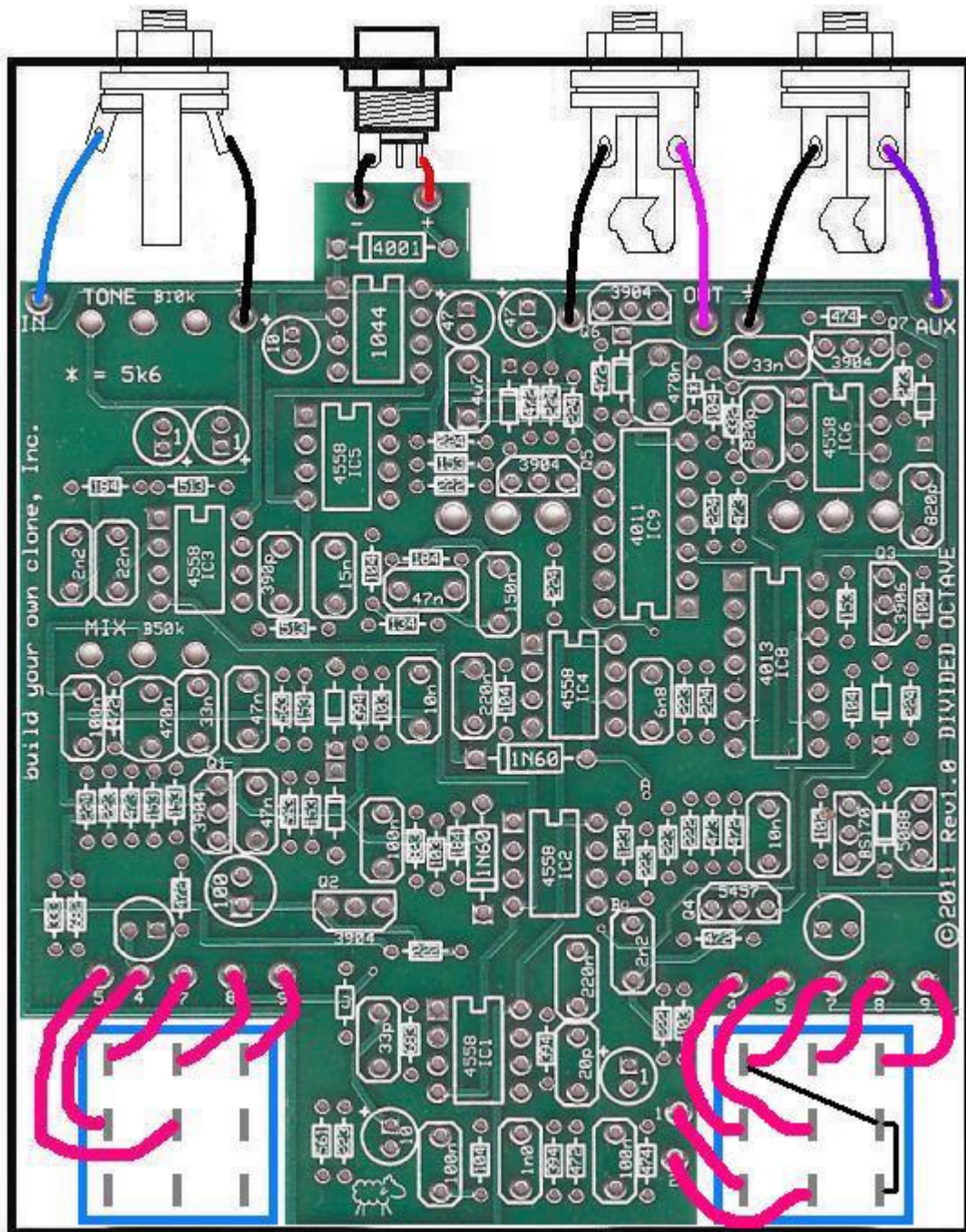

Step 3: Connect the pre stripped and tinned wires to the 1/4" jacks.

Step 4: Cut, strip, and tin the footswitch wires.

- Cut 7 x 3/4" pieces of wire. Strip 1/8" off each end and tin. These will be used to connect lugs/eyelets 7, 8, & 9 of the "bass only" footswitch and 1, 7, 8, & 9 of the bypass footswitch.
- Cut 2 x 1" pieces of wire. Strip 1/8" off each end and tin. These will be used to

connect lug/eyelets 4 of the “bass only” footswitch and 2 & 4 of the “bypass” footswitch.

- Cut 2 x 1.25” peices of wire. Strip 1/8” of each end and tin. These will be used to connect lugs/eyelets 5 of the “bass only” footswitch and 5 of the “bypass” footswitch.

Step 5: Before soldering any of the footswitch wires, use some excess lead clippings to create jumpers between lugs 3 & 6 and between lugs 6 & 7 of the “bypass” footswitch. Insert one of the 3/4” pieces of wire into lug 7 of the “bypass” footswitch so that it is sharing the solder lug with the jumper from lug 6. Now you may solder this and all the other pre-stripped and pre-tinned wires into there respective places on the footswitch.

Step 6: Remove the circuit board from the enclosure. You do not need to remove it entirely, i.e., you do not need to remove the DC adapter jack. You only need to be able to flip the PCB over so that you can solder the footswitch wiring to the PCB.

Step 7: Insert the ends of the wires from the footswitches into their respective eyelets on the PCB. Insert the wires into the top side of the PCB and solder on the bottom side.

Step 8: Return the PCB Assembly back into the enclosure.

Congratulations! You are now finished building your Divided Octave kit. You just need to install the IC's into their sockets.

Installing The ICs

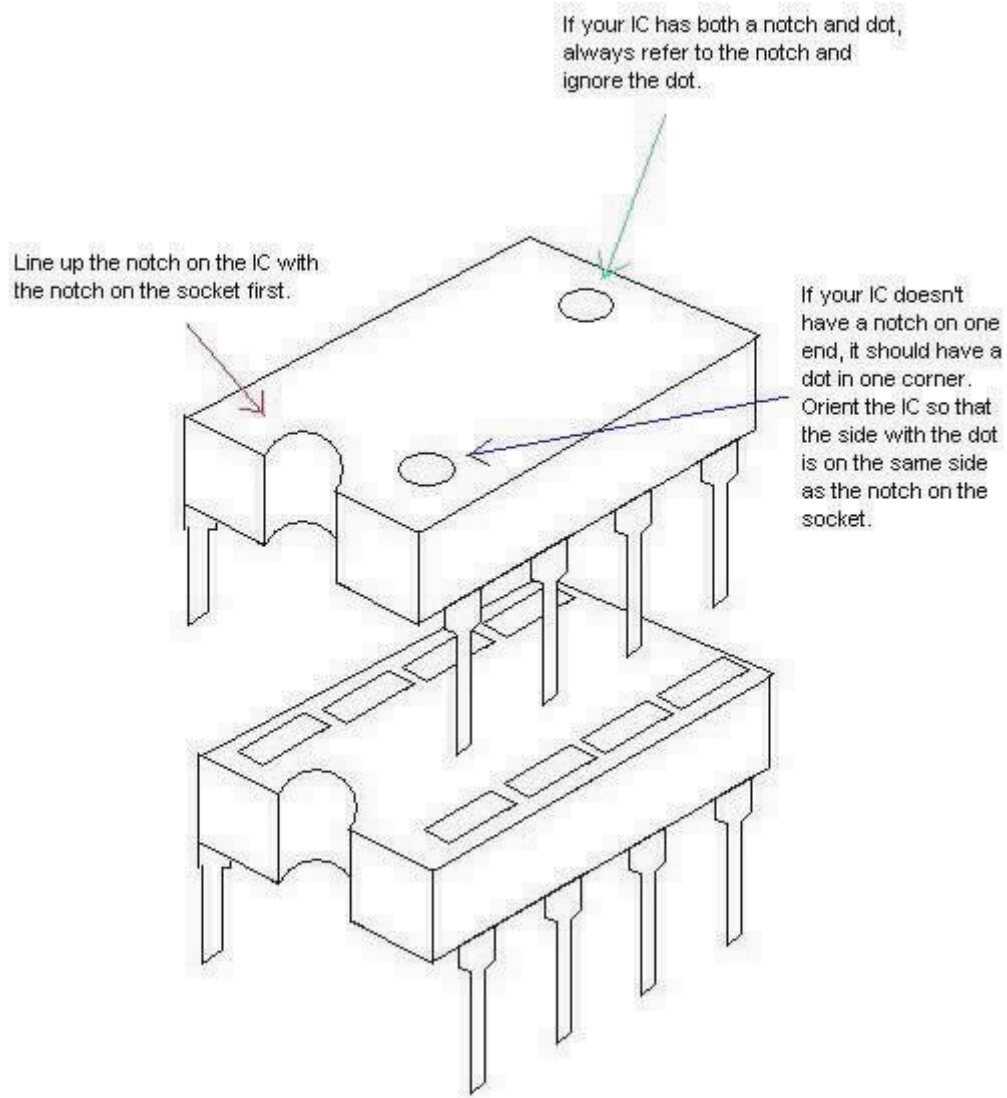

Operating Overview

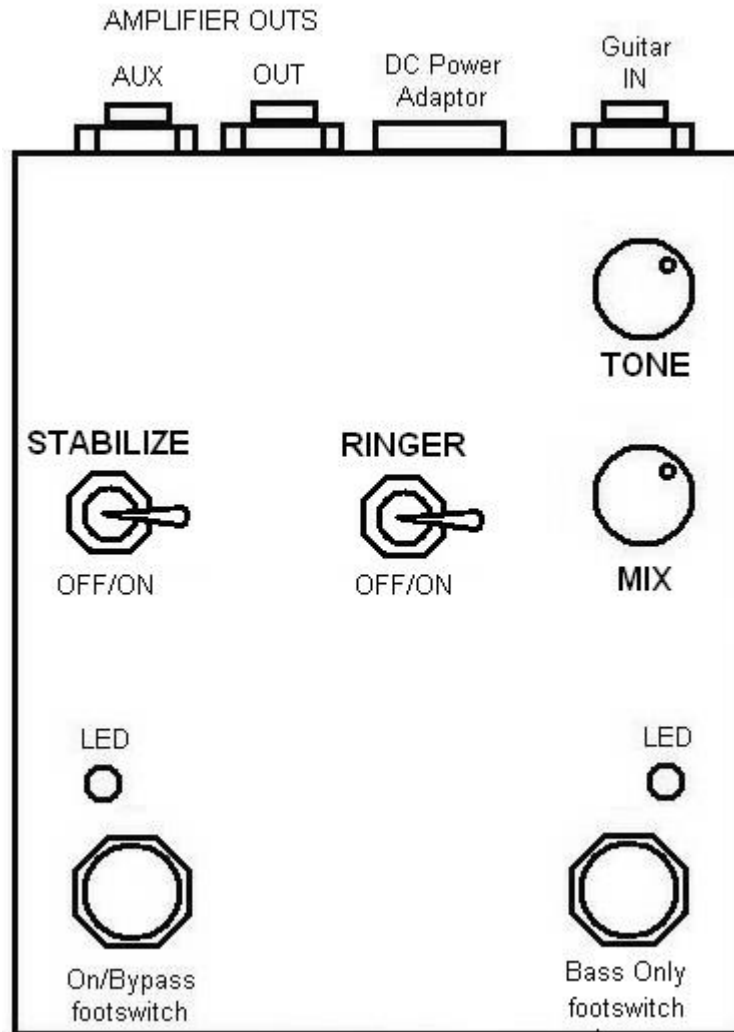

MIX: Blends the Octave down and Ringer with clean signal. Full-turn clockwise is pure clean signal. Full-turn counter-clockwise is pure octave signal.

TONE: Controls the amount of high frequencies cut from the octave down signal.

RINGER: Activates a Green Ringer circuit for an added octave up.

STABILIZE: Improves the octave tracking for some instruments. The usefulness of this feature depends on the frequency range, impedance, and output level of the input instrument. This feature may actually be a hinderance for some instruments.

BASS ONLY: This switch kills the Ringer and clean signals and leaves only the octave down signal

Power supply - Use a 2.5mm negative tip (this is your standard guitar fx style adapter) 9VDC adapter are a 9volt battery.

Current Draw - 12mA

Input Impedance - 470kMeg ohms

Output Impedance - 6.8k ohms (out); 2.2k (aux)

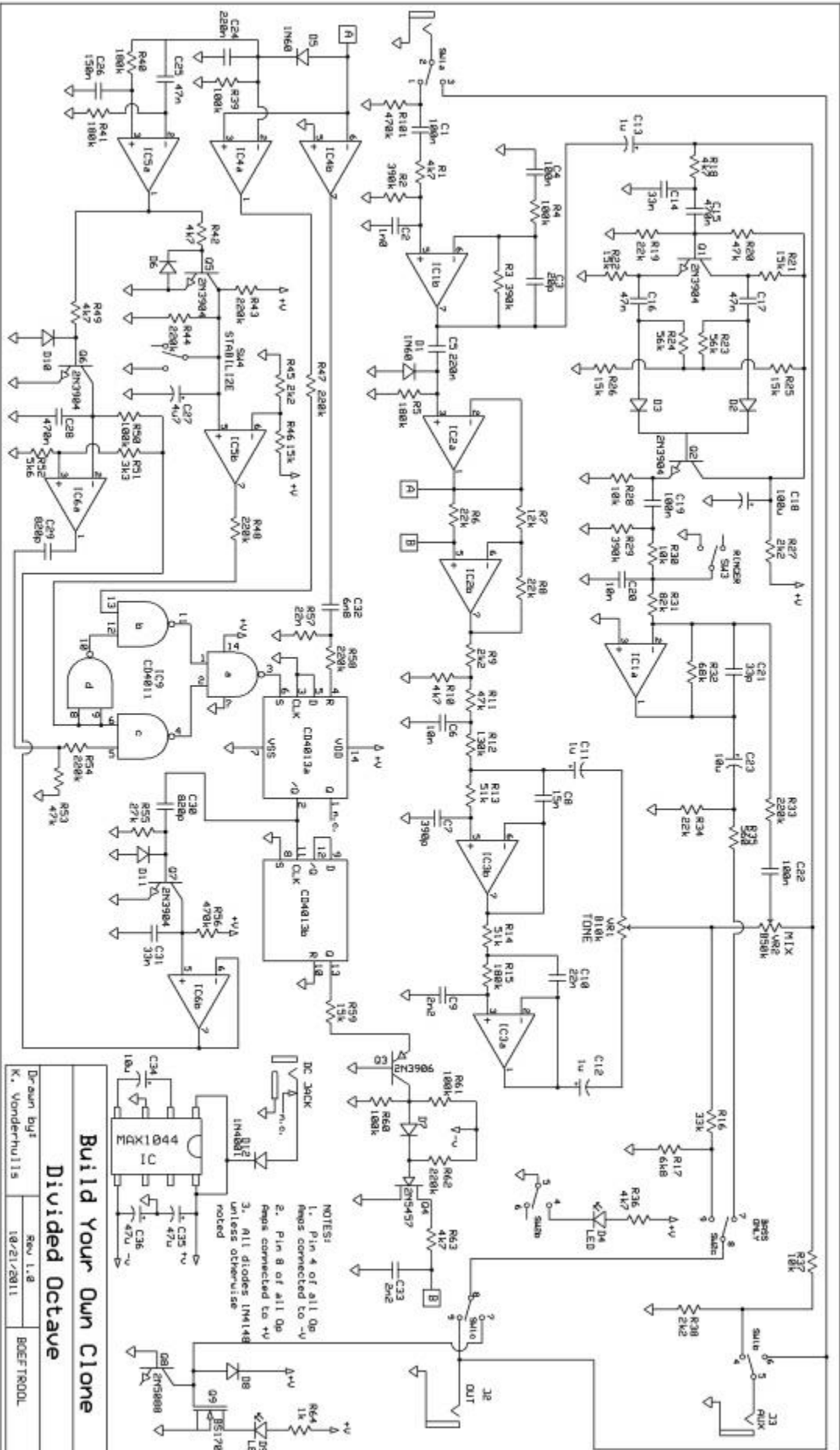

Build Your Own Clone
Divided Octave

Drawn by: **K. Vanderhulst**
 Rev 1.8
 18/21/2011
 BOEFTROOL

- NOTES:
1. Pin 4 of all Op Amps connected to -V
 2. Pin 8 of all Op Amps connected to +V
 3. All diodes 1N4148 unless otherwise noted

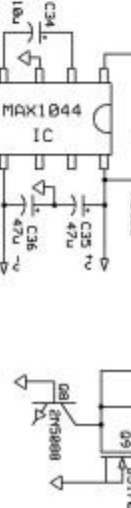

Please visit
<http://buildyourownclone.com/board>
for any technical support

www.buildyourownclone.com/dividedoctaveschematic.pdf
to download high res schematic.

copyright 2011
B.Y.O.C., Inc.