

1PMT5920B Series

3.2 Watt Plastic Surface Mount POWERMITE® Package

This complete new line of 3.2 Watt Zener Diodes are offered in highly efficient micro miniature, space saving surface mount with its unique heat sink design. The POWERMITE package has the same thermal performance as the SMA while being 50% smaller in footprint area and delivering one of the lowest height profiles (1.1 mm) in the industry. Because of its small size, it is ideal for use in cellular phones, portable devices, business machines and many other industrial/consumer applications.

Features

- Zener Breakdown Voltage: 6.2 – 47 V
- DC Power Dissipation: 3.2 W with Tab 1 (Cathode) @ 75°C
- Low Leakage < 5 µA
- ESD Rating of Class 3 (> 16 kV) per Human Body Model
- Low Profile – Maximum Height of 1.1 mm
- Integral Heat Sink/Locking Tabs
- Full Metallic Bottom Eliminates Flux Entrapment
- Small Footprint – Footprint Area of 8.45 mm²
- Supplied in 12 mm Tape and Reel
- Lead Orientation in Tape: Cathode (Short) Lead to Sprocket Holes
- POWERMITE is JEDEC Registered as DO-216AA
- Cathode Indicated by Polarity Band
- These Devices are Pb-Free and are RoHS Compliant

Mechanical Characteristics

CASE: Void-free, transfer-molded, thermosetting plastic

FINISH: All external surfaces are corrosion resistant and leads are readily solderable

MOUNTING POSITION: Any

MAXIMUM CASE TEMPERATURE FOR SOLDERING PURPOSES:
260°C for 10 Seconds



ON Semiconductor®

www.onsemi.com

PLASTIC SURFACE MOUNT 3.2 WATT ZENER DIODES 6.2 – 47 VOLTS

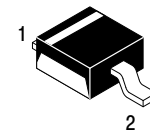
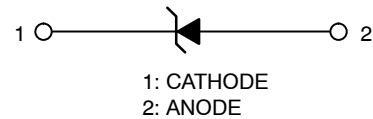

POWERMITE
CASE 457

MARKING DIAGRAM

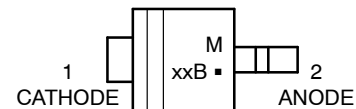

- M = Date Code
- xxB = Specific Device Code
(See Table on Page 2)
- = Pb-Free Package

ORDERING INFORMATION

Device	Package	Shipping†
1PMT59xxBT1G	POWERMITE (Pb-Free)	3000 / Tape & Reel

†For information on tape and reel specifications, including part orientation and tape sizes, please refer to our Tape and Reel Packaging Specifications Brochure, BRD8011/D.

1PMT5920B Series

MAXIMUM RATINGS

Rating	Symbol	Value	Unit
DC Power Dissipation @ $T_A = 25^\circ\text{C}$ (Note 1) Derate above 25°C	P_D	500	mW
Thermal Resistance, Junction-to-Ambient	$R_{\theta JA}$	4.0	$\text{mW}/^\circ\text{C}$
Thermal Resistance, Junction-to-Lead (Anode)	$R_{\theta J\text{anode}}$	248	$^\circ\text{C}/\text{W}$
Thermal Resistance, Junction-to-Lead (Anode)	$R_{\theta J\text{anode}}$	35	$^\circ\text{C}/\text{W}$
Maximum DC Power Dissipation (Note 2) Thermal Resistance from Junction-to-Tab (Cathode)	P_D $R_{\theta J\text{cathode}}$	3.2 23	W $^\circ\text{C}/\text{W}$
Operating and Storage Temperature Range	T_J, T_{stg}	-55 to +150	$^\circ\text{C}$

Stresses exceeding those listed in the Maximum Ratings table may damage the device. If any of these limits are exceeded, device functionality should not be assumed, damage may occur and reliability may be affected.

1. Mounted with recommended minimum pad size, PC board FR-4.
2. At Tab (Cathode) temperature, $T_{\text{tab}} = 75^\circ\text{C}$

ELECTRICAL CHARACTERISTICS ($T_L = 25^\circ\text{C}$ unless otherwise noted, $V_F = 1.5\text{ V Max.}$ @ $I_F = 200\text{ mAdc}$ for all types)

Symbol	Parameter
V_Z	Reverse Zener Voltage @ I_{ZT}
I_{ZT}	Reverse Current
Z_{ZT}	Maximum Zener Impedance @ I_{ZT}
I_{ZK}	Reverse Current
Z_{ZK}	Maximum Zener Impedance @ I_{ZK}
I_R	Reverse Leakage Current @ V_R
V_R	Reverse Voltage
I_F	Forward Current
V_F	Forward Voltage @ I_F

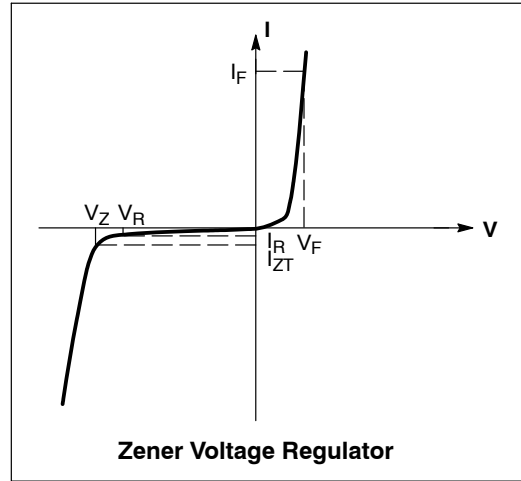

ELECTRICAL CHARACTERISTICS ($T_L = 30^\circ\text{C}$ unless otherwise noted, $V_F = 1.25\text{ Volts}$ @ 200 mA)

Device*	Device Marking	Zener Voltage (Note 3)			I_{ZT}	$I_R @ V_R$	V_R	$Z_{ZT} @ I_{ZT}$ (Note 4)	$Z_{ZK} @ I_{ZK}$ (Note 4)	I_{ZK}
		$V_Z @ I_{ZT}$ (Volts)								
		Min	Nom	Max						
1PMT5920BT1G	20B	5.89	6.2	6.51	60.5	5.0	4.0	2.0	200	1.0
1PMT5921BT1G	21B	6.46	6.8	7.14	55.1	5.0	5.2	2.5	200	1.0
1PMT5924BT1G	24B	8.64	9.1	9.56	41.2	5.0	7.0	4.0	500	0.5
1PMT5927BT1G	27B	11.4	12	12.6	31.2	1.0	9.1	6.5	550	0.25
1PMT5929BT1G	29B	14.25	15	15.75	25	1.0	11.4	9.0	600	0.25
1PMT5933BT1G	33B	20.9	22	23.1	17	1.0	16.7	17.5	650	0.25
1PMT5934BT1G	34B	22.8	24	25.2	15.6	1.0	18.2	19	700	0.25
1PMT5935BT1G	35B	25.65	27	28.35	13.9	1.0	20.6	23	700	0.25
1PMT5941BT1G	41B	44.65	47	49.35	8.0	1.0	35.8	67	1000	0.25

Product parametric performance is indicated in the Electrical Characteristics for the listed test conditions, unless otherwise noted. Product performance may not be indicated by the Electrical Characteristics if operated under different conditions.

3. Zener voltage is measured with the device junction in thermal equilibrium with an ambient temperature of 25°C .
4. Zener Impedance Derivation Z_{ZT} and Z_{ZK} are measured by dividing the AC voltage drop across the device by the AC current applied. The specified limits are for $I_{Z(\text{ac})} = 0.1 I_{Z(\text{dc})}$ with the ac frequency = 60 Hz.

1PMT5920B Series

TYPICAL CHARACTERISTICS

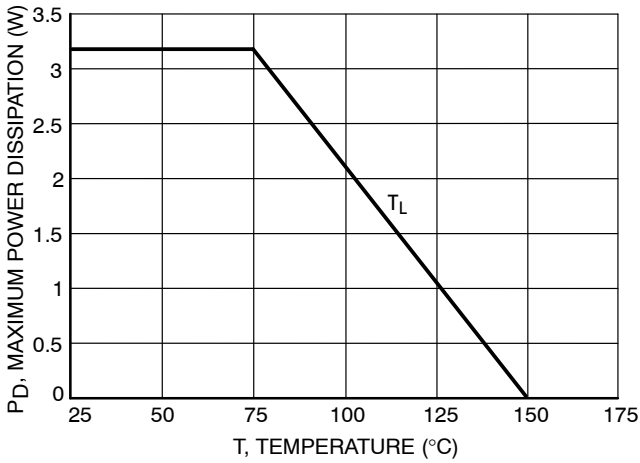

Figure 1. Steady State Power Derating

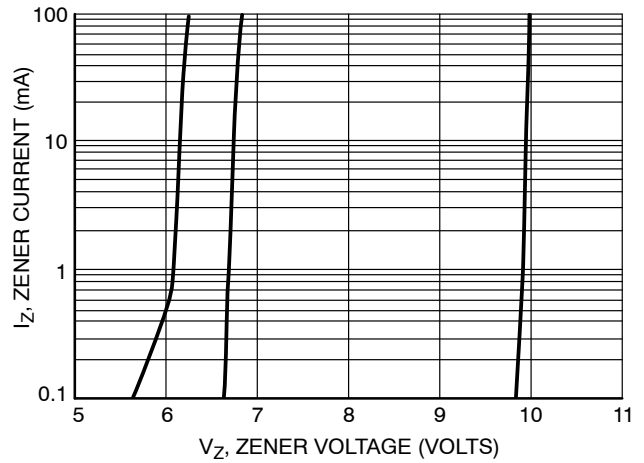

Figure 2. V_Z to 10 Volts

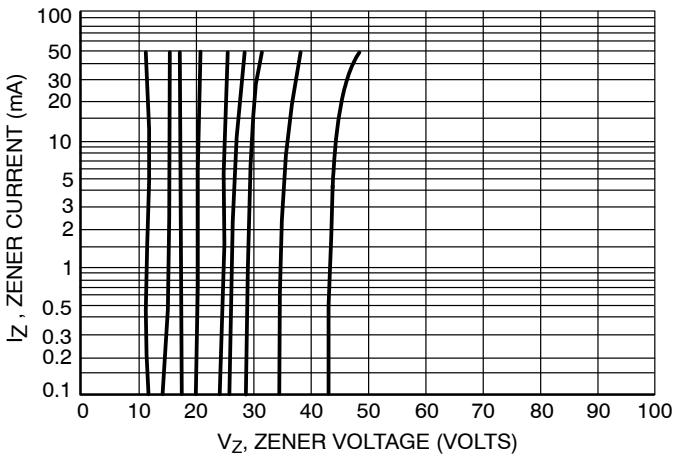

Figure 3. $V_Z = 12$ thru 47 Volts

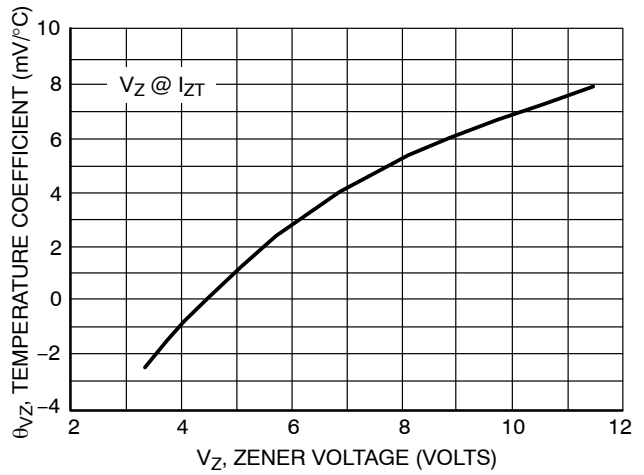

Figure 4. Zener Voltage - To 12 Volts

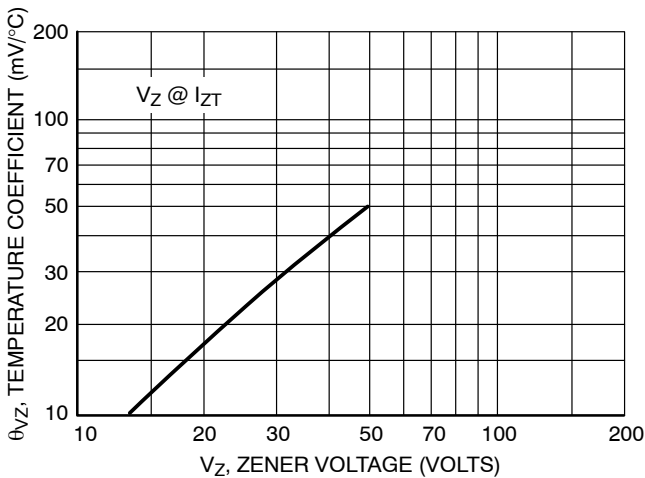

Figure 5. Zener Voltage - 14 To 47 Volts

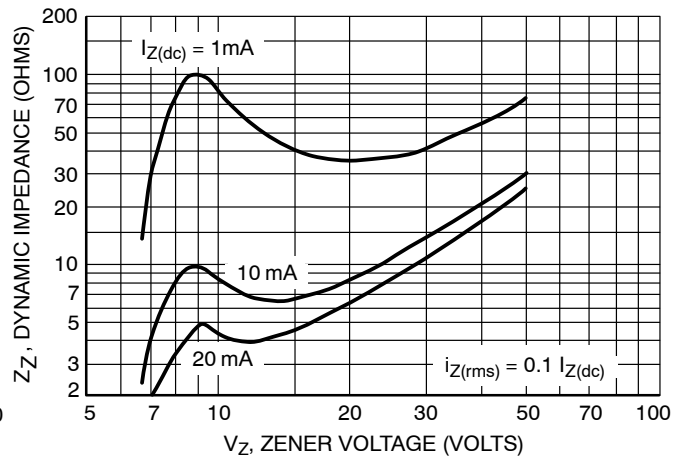

Figure 6. Effect of Zener Voltage

1PMT5920B Series

TYPICAL CHARACTERISTICS

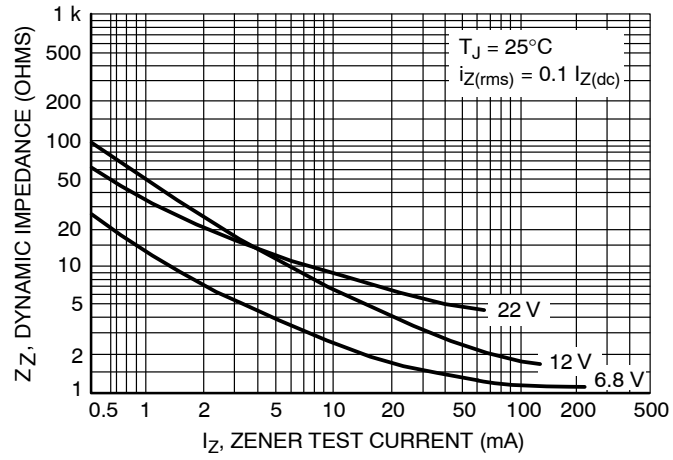

Figure 7. Effect of Zener Current

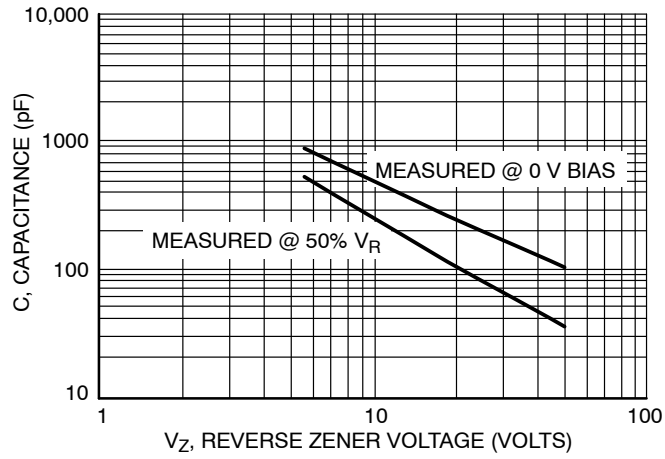
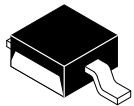

Figure 8. Capacitance versus Reverse Zener Voltage

MECHANICAL CASE OUTLINE

PACKAGE DIMENSIONS



SCALE 4:1

POWERMITE CASE 457 ISSUE G

DATE 12 JAN 2022

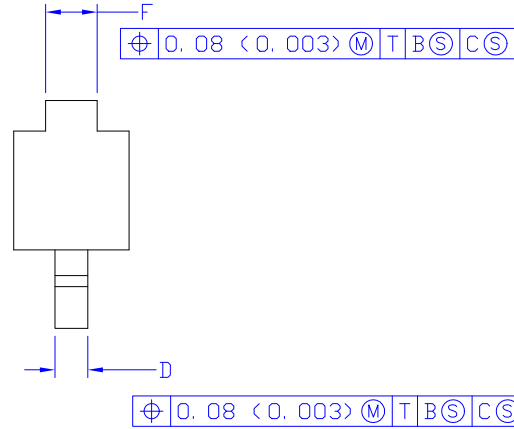
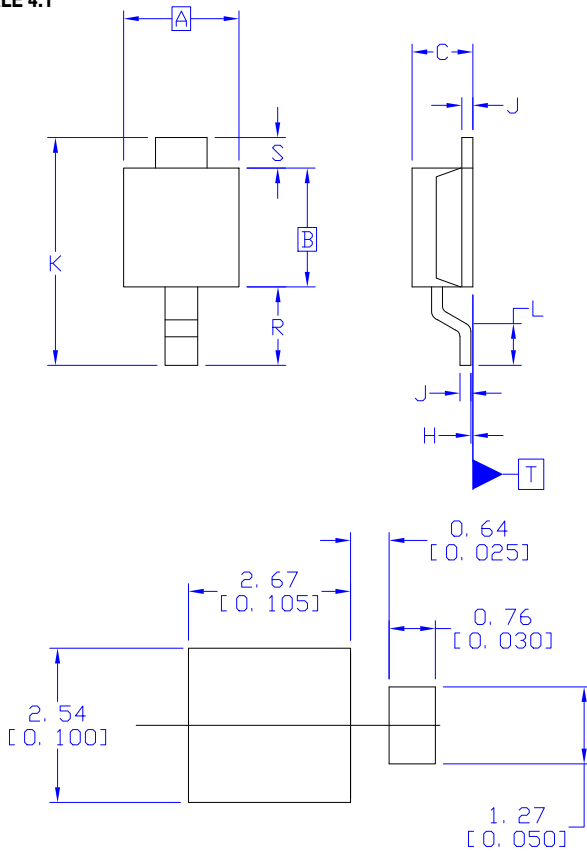

RECOMMENDED
MOUNTING FOOTPRINT

DIM	MILLIMETERS		INCHES	
	MIN.	MAX.	MIN.	MAX.
A	1.75	2.05	0.069	0.081
B	1.75	2.18	0.069	0.086
C	0.85	1.15	0.033	0.045
D	0.40	0.69	0.016	0.027
F	0.70	1.00	0.028	0.039
H	-0.05	0.10	-0.002	0.004
J	0.10	0.25	0.004	0.010
K	3.60	3.90	0.142	0.154
L	0.50	0.80	0.020	0.031
R	1.20	1.50	0.047	0.059
S	0.50 REF		0.019 REF	

GENERIC MARKING DIAGRAMS*

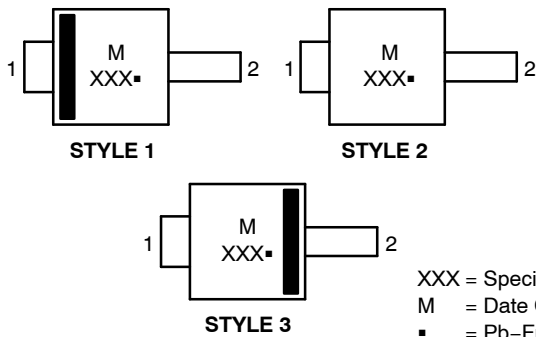

XXX = Specific Device Code
M = Date Code
■ = Pb-Free Package

NOTES:

- DIMENSIONING AND TOLERANCING PER ASME Y14.5M, 1994.
- CONTROLLING DIMENSION: MILLIMETERS
- DIMENSION *b* APPLIES TO PLATED TERMINAL AND IS MEASURED BETWEEN 0.15 AND 0.30mm FROM THE TERMINAL TIP.

STYLE 1:

- CATHODE
- ANODE

STYLE 2:

- ANODE OR CATHODE
- CATHODE OR ANODE (BI-DIRECTIONAL)

STYLE 3:

- ANODE
- CATHODE

*This information is generic. Please refer to device data sheet for actual part marking. Pb-Free indicator, "G" or microdot "▪", may or may not be present. Some products may not follow the Generic Marking.

DOCUMENT NUMBER:	98ASB14853C	Electronic versions are uncontrolled except when accessed directly from the Document Repository. Printed versions are uncontrolled except when stamped "CONTROLLED COPY" in red.
DESCRIPTION:	POWERMITE	PAGE 1 OF 1

onsemi and ONSEMI are trademarks of Semiconductor Components Industries, LLC dba onsemi or its subsidiaries in the United States and/or other countries. onsemi reserves the right to make changes without further notice to any products herein. onsemi makes no warranty, representation or guarantee regarding the suitability of its products for any particular purpose, nor does onsemi assume any liability arising out of the application or use of any product or circuit, and specifically disclaims any and all liability, including without limitation special, consequential or incidental damages. onsemi does not convey any license under its patent rights nor the rights of others.

onsemi, **Onsemi**, and other names, marks, and brands are registered and/or common law trademarks of Semiconductor Components Industries, LLC dba "**onsemi**" or its affiliates and/or subsidiaries in the United States and/or other countries. **onsemi** owns the rights to a number of patents, trademarks, copyrights, trade secrets, and other intellectual property. A listing of **onsemi**'s product/patent coverage may be accessed at www.onsemi.com/site/pdf/Patent-Marking.pdf. **onsemi** reserves the right to make changes at any time to any products or information herein, without notice. The information herein is provided "as-is" and **onsemi** makes no warranty, representation or guarantee regarding the accuracy of the information, product features, availability, functionality, or suitability of its products for any particular purpose, nor does **onsemi** assume any liability arising out of the application or use of any product or circuit, and specifically disclaims any and all liability, including without limitation special, consequential or incidental damages. Buyer is responsible for its products and applications using **onsemi** products, including compliance with all laws, regulations and safety requirements or standards, regardless of any support or applications information provided by **onsemi**. "Typical" parameters which may be provided in **onsemi** data sheets and/or specifications can and do vary in different applications and actual performance may vary over time. All operating parameters, including "Typicals" must be validated for each customer application by customer's technical experts. **onsemi** does not convey any license under any of its intellectual property rights nor the rights of others. **onsemi** products are not designed, intended, or authorized for use as a critical component in life support systems or any FDA Class 3 medical devices or medical devices with a same or similar classification in a foreign jurisdiction or any devices intended for implantation in the human body. Should Buyer purchase or use **onsemi** products for any such unintended or unauthorized application, Buyer shall indemnify and hold **onsemi** and its officers, employees, subsidiaries, affiliates, and distributors harmless against all claims, costs, damages, and expenses, and reasonable attorney fees arising out of, directly or indirectly, any claim of personal injury or death associated with such unintended or unauthorized use, even if such claim alleges that **onsemi** was negligent regarding the design or manufacture of the part. **onsemi** is an Equal Opportunity/Affirmative Action Employer. This literature is subject to all applicable copyright laws and is not for resale in any manner.

PUBLICATION ORDERING INFORMATION

LITERATURE FULFILLMENT:

Email Requests to: orderlit@onsemi.com

onsemi Website: www.onsemi.com

TECHNICAL SUPPORT

North American Technical Support:

Voice Mail: 1 800-282-9855 Toll Free USA/Canada

Phone: 011 421 33 790 2910

Europe, Middle East and Africa Technical Support:

Phone: 00421 33 790 2910

For additional information, please contact your local Sales Representative