

I42

2MP Zoom Bullet with D/N, Adaptive IR, Extreme WDR, ELLS, 36x Zoom Lens



- 2 Megapixel
- Day & Night with Extreme Low Light Sensitivity and Adaptive IR LED
- 36x Zoom Lens with f4.6-165.6mm/F1.55-F5.0, DC iris, Auto focus
- Extreme WDR
- Event trigger, response and notification

► Specifications

Device

Product Type	Zoom Bullet
Maximum Resolution	2MP
Application Environment	Outdoor
Image Sensor	Progressive Scan CMOS
Sensor Size	1/2.8 "
Effective Pixels	1945(H) X 1097(V) (2.13 MP)
Day / Night	Yes
Low Light Sensitivity	Extreme
Minimum Illumination	Color: 0.002 lux at F1.55; B/W: 0.001 lux at F1.55; B/W: 0 lux (IR LED on)
Color to B/W Switch	ISP based switch, configurable
Mechanical IR Cut Filter	Yes
IR Sensitivity Range	700-1100nm
IR LED	Adaptive IR LED x 27 (850 nm)
IR Working Distance	40m
Electronic Shutter	1-1/64000 second (manual mode); 1-1/64000 second (auto mode)

Horizontal Resolution (TV Lines)	1800 TVL
S/N Ratio	56 dB

Lens

Focal Length	Zoom, f4.6-165.6mm
Aperture	F1.55-F5.0
Zoom Ratio	36x optical zoom
Zoom Application	Camera Installation, Auto Zoom by Event, Manual Operation
Iris	DC iris
Focus	Auto focus
Lens Mount	Board mount
Horizontal Viewing Angle	62.7° - 2.7°
Vertical Viewing Angle	38.5° - 1.6°

PTZ

Absolute Position	Yes
Pan, Tilt or Zoom protocol	Visca, Pelco-D, Pelco-P, ACTi URL command

Video

Compression	H.264 (Baseline/ Main/ High profile), MJPEG
Maximum Frame Rate vs. Resolution	(60Hz) 60 fps at 1920 x 1080 60 fps at 1280 x 720 30 fps at 640 x 480 30 fps at 320 x 240 (50Hz) 50 fps at 1920 x 1080 50 fps at 1280 x 720 25 fps at 640 x 480 25 fps at 320 x 240
High Frame Mode	Support
Multi-Streaming	Simultaneous triple streams based on three configurations
Bit Rate	128Kbps - 12Mbps (per stream)
Bit Rate Mode	Constant, Variable
Wide Dynamic Range	Extreme WDR (145 dB)
Image Enhancement	White Balance, Brightness, Contrast, Sharpness, Automatic gain control, Flickerless, Digital Image Stabilizer (DIS, EIS), Defogging
Digital Noise Reduction	2D + 3D DNR
Privacy Mask	20 configurable 3D privacy masks
Text Overlay	Yes
On-Screen Graphics	Yes
Built-in Analytics	Basic Face Detection, Object Based Motion Detection, Tampering Detection, Shock Detection, Object Line Crossing Detection, Object Enter Area Detection, Missing Object Detection, Unattended Object Detection, Object Loitering Detection
Server-based Analytics	Object Line Counting, People Counting, Face Detection, Object Based Motion Detection, Tamper, Object Line Crossing Detection, Object Enter Area Detection, Missing Object Detection, Unattended Object Detection, Smoke Detection, Heat Map, Dwell Time, Direction Detection, Automatic License Plate Recognition, People Queue Detection, (Require PC-based or standalone IVS or ALPR Server. Contact ACTi support for recommendations on how to maximize analytical accuracy)

Image Orientation	Rotation (Corridor mode)
IVS performance	Certain algorithms may require more computing power, which may limit the number of algorithms that can be concurrently used in the camera. Please test the actual performance before using in a project.

Audio

Audio Type	2-way, Line-in, Line-out
Audio Compression	8 kHz, 16 bit encoding, Mono, PCM, G.711

Network

Network Protocol & Service	IPv4/v6, TCP, UDP, DHCP, PPPoE, HTTP, HTTPS, DNS, DDNS, NTP, RTP, RTSP, RTCP, SMTP, FTP, IGMP, ICMP, ARP, Bonjour, UPnP, QoS, SNMP, IEEE 802.1X
Ethernet Port	1 x RJ-45 pigtail connector
Security	IP address filtering, HTTPS encryption, Password protected user level, Anonymous login, IEEE 802.1X network access control

Video Analytics

Analysis Source Type	Video
Metadata Accuracy	Standard

Event

Event Trigger	Video motion detection (10 included and excluded polygonal regions), External device through digital input, Sound detection, Intelligent event detection, Video streams loss, System log buffer overrun, Remove system log, Logon events (Login Failure, Login Success, Block an Account)
Event Response	Notify control center, Go to Zoom preset point or preset tour, Change camera settings, Command other devices, E-mail notification with snapshots, Play the audio file, Push notification to mobile device, Save video to local storage, Upload video to NVR server, Upload video or snapshot to FTP server, Activate external device through digital output, Change video resolution and frame rate

System

System Log	Support
Watchdog	Support

Integration

Unified Solution	Fully compatible with ACTi software
GPS Position	Manual setting
Edge Recording	Support (integration with NVR by ONVIF Profile G or proprietary protocol)**
ONVIF Compliant	Yes, Profile S, Profile G, Profile T, Profile Q
Web Browser	IE 11, Google Chrome*, Microsoft Edge*, Apple Safari*
Auto Firmware Upgrade	Yes

Interface

Local Storage	MicroSD, MicroSDHC, MicroSDXC Memory Card Slot (card not included, up to 256GB, Kingston or Sandisk only)
Digital Input/Output	1/1
Operating Button	Reset Button

General

Power Source	DC 12V, PoE Class 3 (IEEE802.3af)
Power Consumption	12.6 W (PoE, heater and IR on), 10.3 W (DC, heater and IR on)
Weight	2257g (4.98lb)
Dimensions	(W x H x D): 122.4mm x 124.1mm x 362.6mm (4.82" x 4.89" x 14.28")
Environmental Casing	Weatherproof (IP66), Vandal proof metal casing (IK10)
Bundled Accessories	Integrated bracket
Mount Type	Wall Mount, Ceiling Bracket, Pole Mount, Gang Box
Heater	Yes
Starting Temperature	-30°C ~ 50°C (-22°F ~ 122°F) within 30 minutes
Operating Temperature	-40°C ~ 50°C (-40°F ~ 122°F)
Approvals	CE Class B, FCC Class B, EAC, IP66, IK10 (metal casing), NEMA 4X, UL (for optional PoE injector and power adapter)
Real-time Clock (RTC)	Yes
Warranty	3 Year(s). For extended warranty offering, see http://www.acti.com/support/warranty

* cross-browser compatibility: Not available for H.265 video decoding ** Edge Recording function is integrated with NVR 3 Corporate / NVR 3 Business / INR / GNR series.

► Photo Indication

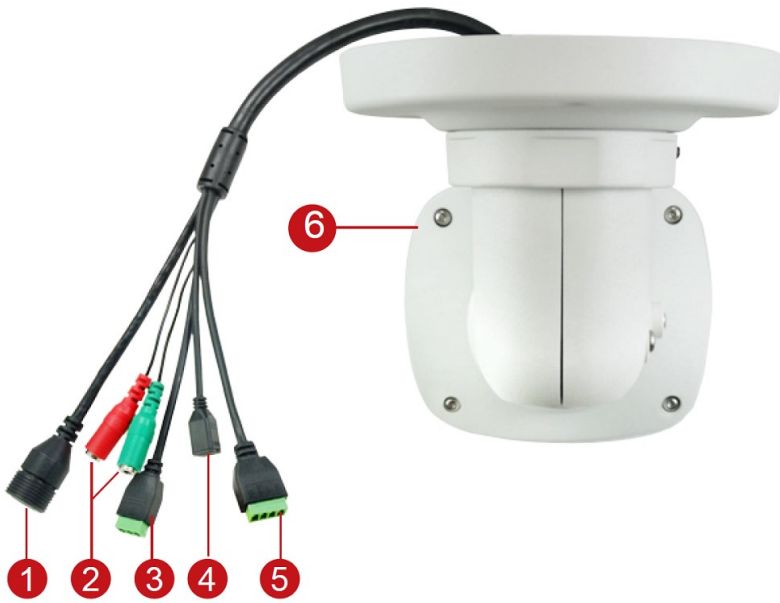

- 1 Ethernet Port
- 2 Audio Input / Output
- 3 DC 12V Power Input
- 4 Reset Button
- 5 Digital Input/Output
- 6 Memory Card Slot (inside the back panel cover)

► Dimension Diagram

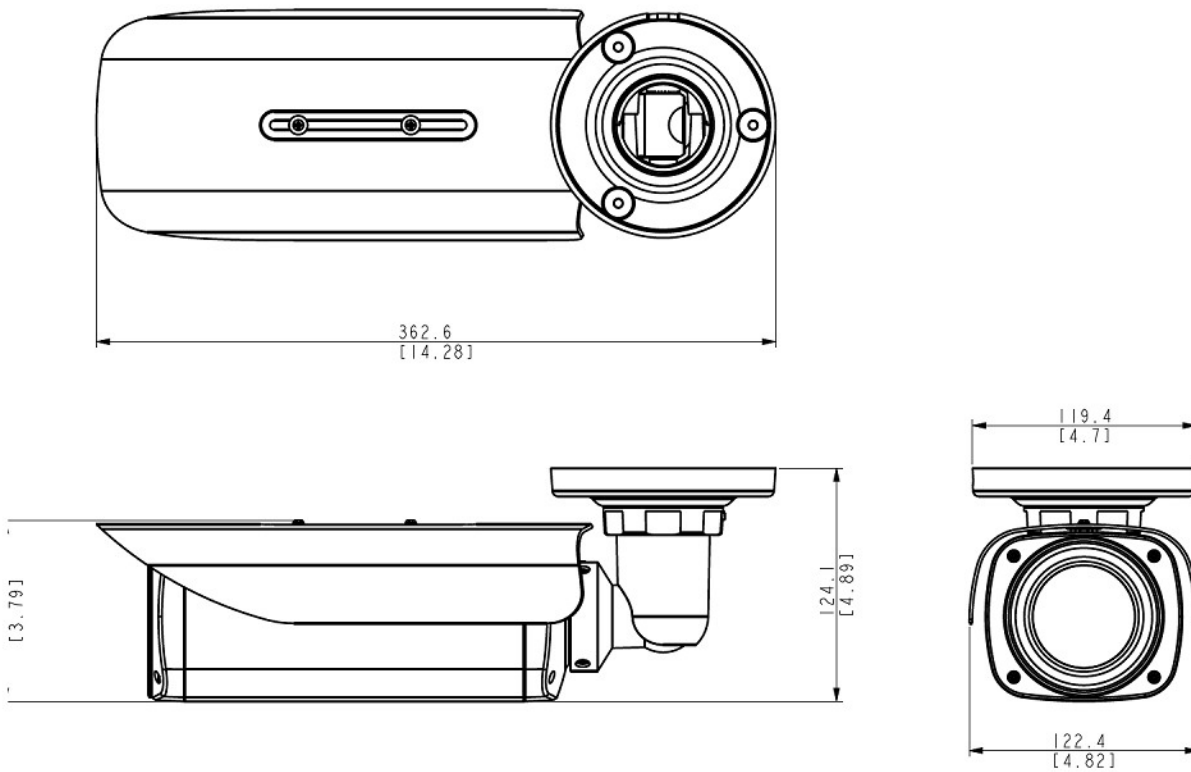









Unit: mm [inch]

▶ Related Products

Bullet - Bullet

E43B		5MP Bullet with D/N, Adaptive IR, Basic WDR, Vari-focal lens, f2.8-12mm/F1.4 (HOV:69.2°-28.2°), H.264, 1080p/30fps, DNR, Audio, MicroSDHC/MicroSDXC, PoE, IP68, IK10 (metal casing), DI/DO
------	---	--

Mounting Accessories - Camera Mount

PMAX-0504		Pole Mount (for B4x, B41x, E44, E45, E46, E48, E44A, E45A, E46A, E41x, I4x, PMAX-0330), supports 3.25" to 7.0" Poles
PMAX-0505		Pole Mount (for B4x, B41x, E44, E45, E46, E48, E44A, E45A, E46A, E41x, I4x, PMAX-0312, PMAX-0313, PMAX-0314, PMAX-0330), supports 2" to 3" Poles
PMAX-0508		Pole Mount (for PMAX-0203, PMAX-0204, PMAX-0205, PMAX-0206, PMAX-0704), supports 3" to 9" Poles
PMAX-0512		Pole Mount (for E39, PMAX-0706), supports 3.25" to 7.0" Poles
PMAX-0704		Junction Box (for A4x, B4x, B41x, E44, E45, E46, E48, E44A, E45A, E46A, E41x, I4x, PMAX-0203~PMAX-0205)
PMAX-0706		Junction Box (for A3x, A4x, E39, E41x, PMAX-0805)
PMAX-0806		Gang Box Converter (for B4x, E39, E44, E45, E46, E44A, E45A, E46A), supports 4" Round and 4" Octagon Boxes
R706-00006		Back Bracket with Pre-installed (For B41x, B43, I42, I48, E413, E415, E417)

Note: Some mounting accessories may need additional accessories for installation. Please check www.acti.com/mountingselector for more information.

Bullet Covers - Front Cover

R700-00008		Front Cover (for B415, B416, I42, I48)
------------	---	--

Power Supply Accessories - Power Adapter

PPBX-0011		Power Adapter AC 100~240V, with universal connectors for all DC12V powered devices
-----------	---	--

Power Supply Accessories - PoE Injector

PPOE-0002		PoE Injector IEEE 802.3af compliant, AC 100~240V, with universal connectors
-----------	---	---

Network & Storage Peripherals - Data Switch

PPSW-0100		PLANET FGSD-910HP 8-Port 802.3at PoE Switch (PoE Budget 120W)
PPSW-0102		PLANET FGSD-1011HP 8-Port 802.3at PoE Switch (PoE Budget 120W)

PPSW-0105  PLANET GS-4210-8P2C 8-Port Gigabit 802.3at Managed PoE Switch (PoE Budget 120W)

PPSW-1101  PLANET GS-4210-24PL4C 24-Port Gigabit 802.3at Managed PoE Switch (PoE Budget 440W)

PPSW-2101  4-Port 802.3at PoE Switch (PoE Budget 62W)

PPSW-3100  PLANET FGSW-1816HPS 16-Port 802.3at PoE Switch (PoE Budget 220W)

Extenders - PoE Extender

PPEX-0100  Veracity OUTREACH Max Power over Ethernet (PoE) Extender

Extenders - PoE over Coaxial Extender Kit

PPOC-0100  Planet LRP-101C-KIT Power over Coax Adapter Kit

Audio Devices - Microphone

PMIC-0100  Active Microphone Omnidirectional for all Cameras with Line-in Audio

Illuminators - IR LED Illuminator

PLED-0200  SPINLUX (SL-A2IRXX10-24CL) IR Illuminator 10° Angle with 120 m approx. range

PLED-0201  SPINLUX (SL-A2IRXX25-24CL) IR Illuminator 25° Angle with 50 m approx. range

PLED-0202  SPINLUX (SL-A2IRXX35-24CL) IR Illuminator 35° Angle with 25 m approx. range

Other Accessories - Camera Part

R716-00001  Sunshield (for B4x, I4x)

Product Demo - Camera Demo Kit

PCDK-0001  Camera Demo Kit Rack Box (350 x 550 x 140 mm) for all cameras except Mini Domes