

THIS DOCUMENT IS THE PROPERTY OF
KEYSTONE ELECTRONICS CORP. AND
SHALL NOT BE REPRODUCED, DISTRIBUTED
OR USED AS A BASIS FOR MANUFACTURE
WITHOUT PRIOR WRITTEN PERMISSION
FROM KEYSTONE ELECTRONICS CORP.

ACTUAL SIZE

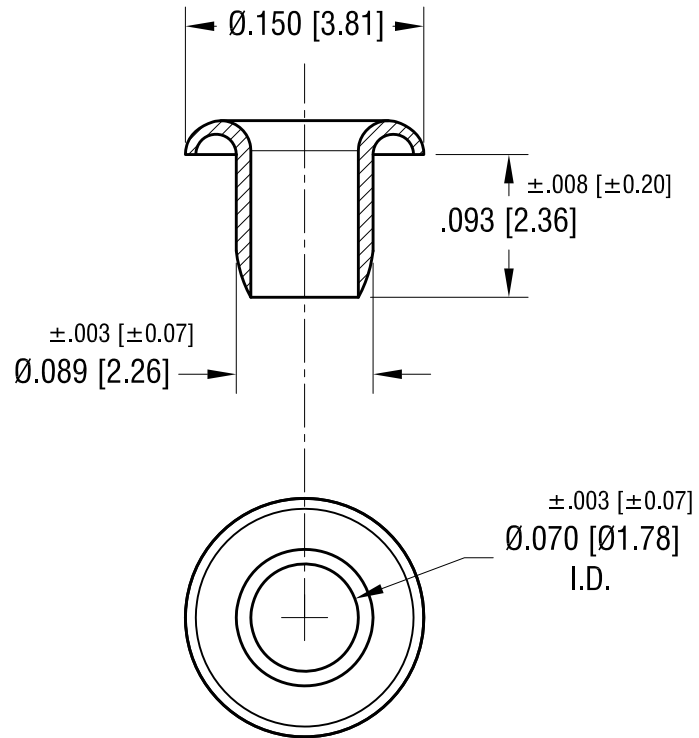

KEYSTONE ELECTRONICS CORP.

www.keyelco.com • NEW HYDE PARK NY 11040 • Tel (516)328-7500

PART NAME		WIDE ROLL EYELET	
MATERIAL		.009 [0.22] BRASS	
FINISH		DRN BY	DATE
TIN PLATE		BOONE	10.30.06
		APP'D	SCALE
		MR	8X
TOLERANCES	INCH [MM]	CODE	DWG NO.
DECIMAL	± .005 [± 0.13]	C	33
ANGULAR	± 1°		
UNLESS OTHERWISE SPECIFIED			

4.10.23	SPLIT C/M TO 'C' &'M' CHANGE AS PER ECN 23-050	A
DATE	DESCRIPTION	REV.