

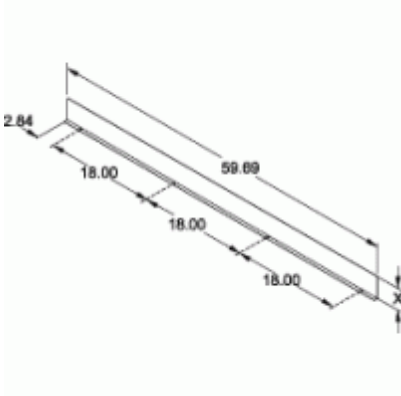

Quality Products. Service Excellence.

Barrier Kit 1487 B Series



- Divides wireway into two or more compartments. Barriers are fastened to wireway sections with screws.

Part No.	For use with	Length	H
1487CB60	4 x 4	59.69	3.72
1487DB60	6 x 6	59.69	5.72
1487EB60	8 x 8	59.69	7.72

Does not meet CSA or UL requirements

Data subject to change without notice



© 2023. Hammond Manufacturing Ltd. All rights reserved.