

FL SWITCH 2214-2SFX PN - Industrial Ethernet Switch



1044030

<https://www.phoenixcontact.com/us/products/1044030>

Please be informed that the data shown in this PDF document is generated from our Online Catalog. Please find the complete data in the user documentation. Our General Terms of Use for Downloads are valid.



Managed Switch 2000, 14 RJ45 ports 10/100 Mbps, 2 SFP ports 100 Mbps, PROFINET Conformance-Class B, PROFINET mode preset, PROFINET status LEDs, extended temperature range

Your advantages

- MRP (client and manager)
- VLANs
- DHCP client, DHCP server (pool-based and port-based), DHCP option 82
- RSTP
- Ambient temperature -40 °C ... 70 °C
- Web-based management, SNMP
- Configuration memory
- Easy and fast startup and commissioning with the FL NETWORK MANAGER software
- PROFINET mode preset

Commercial Data

Item number	1044030
Packing unit	1 pc
Minimum order quantity	1 pc
Sales Key	DN17
Product Key	DNN121
Catalog Page	Page 312 (C-6-2019)
GTIN	4055626611792
Weight per Piece (including packing)	640 g
Weight per Piece (excluding packing)	470 g
Customs tariff number	85176200
Country of origin	DE

FL SWITCH 2214-2SFX PN - Industrial Ethernet Switch



1044030

<https://www.phoenixcontact.com/us/products/1044030>

Technical Data

Dimensions

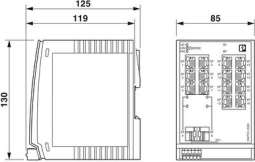
Dimensional drawing	
Width	85 mm
Height	130 mm
Depth	119 mm

Notes

General	Support by phone or on-site (fee is charged)
---------	--

Material specifications

Housing material	Polycarbonate fiber reinforced
------------------	--------------------------------

Mounting

Mounting type	DIN rail mounting
---------------	-------------------

Interfaces

Ethernet (RJ45)

Connection method	RJ45
Note on the connection method	Auto negotiation and autocrossing
Transmission speed	10/100 Mbps
Transmission physics	Copper
Transmission length	100 m (per segment)
Signal LEDs	Data receive, link status
No. of channels	14 (RJ45 ports)

Ethernet (SFP)

Number of interfaces	2
Connection method	SFP
Transmission speed	100 Mbps (full duplex)
Transmission physics	Depending on the SFP module
Transmission length	up to 40 km (Depending on the fiber/SFP module used)
Signal LEDs	Data receive, link status
No. of channels	2 (SFP ports)

Output data

Digital

FL SWITCH 2214-2SFX PN - Industrial Ethernet Switch



1044030

<https://www.phoenixcontact.com/us/products/1044030>

Output name	Alarm output
-------------	--------------

Product properties

Type	Book type
Product type	Switch
Product family	Managed Switch 2000
MTTF	365.63 Years (SN 29500 standard, temperature 25°C, operating cycle 21%)
	218.22 Years (SN 29500 standard, temperature 40°C, operating cycle 34.25%)
	31.7 Years (SN 29500 standard, temperature 55°C, operating cycle 100%)
Special properties	PROFINET mode preset, PROFINET status LEDs, extended temperature range
Signal delay	≥ 6.5 μs (Store and Forward mode, 10/100 Mbps, depending on the frame size)

Insulation characteristics

Protection class	III (VDE 0106)
Degree of pollution	2

Switch functions

Diagnostic functions	RMON History
	LLDP (Link Layer Discovery Protocol)
	SNMP-Traps
	N:1-Portmirroring
	ACD (Address Conflict Detection)
	SysLog
	CRC-Surveillance
Basic functions	Store-and-forward switch, complies with IEEE 802.3
Signal contact control voltage	typ. 24 V DC
PROFINET conformance class	Conformance-Class B
PROFINET device function	PROFINET device
	Fast Startup
Filter functions	Quality of Service (8 priority classes)
	Class of Service
	DiffServ/DSCP
	Port-Priorisierung
	VLAN (up to 32 VLANs)
	IGMP Snooping/Querier (v1/v2)
	Auto-Query-Port
	Extended Multicast Filtering
IP parameterization	DHCP-Client
	DHCP Option 82 (Relay Agent)
	DHCP server (pool-based, port-based)
	BootP

FL SWITCH 2214-2SFX PN - Industrial Ethernet Switch



1044030

<https://www.phoenixcontact.com/us/products/1044030>

	DCP (Discovery and Configuration Protocol)
MAC address table	8k
Management	Web-based management (HTTP/HTTPS)
	Role-based user management (LDAP, RADIUS)
	SNMPv1/v2/v3
	Command-line interface (Telnet, SSH)
Redundancy	MRP (Media Redundancy Protocol)
	RSTP (Rapid Spanning Tree Protocol)
	FRD (Fast Ring Detection)
	Large Tree Support
	LACP (Link Aggregation Control Protocol)
	PROFINET S2 system redundancy
Status and diagnostic indicators	LEDs: US1, US2 (power supply), Fail (alarm contact), 2 LEDs per Ethernet port (link/activity and speed), PROFINET status LEDs (BF, SF)
Additional functions	Transmission of MMS and GOOSE (IEC 61850-8-1)
	Transmission of Modbus/TCP
Time synchronization	SNTP (Simple Network Time Protocol)

Security functions

Port security	MAC-based, RADIUS (IEEE 802.1X), MAC Authentication Bypass
Basic functions	Store-and-forward switch, complies with IEEE 802.3

Electrical properties

Local diagnostics	US1/2 Supply voltage US1, US2 Green LED
	FAIL Div. LED red
	LINK Link status Green LED
	BF Bus errors LED red
	SF Group error LED red
Maximum power dissipation for nominal condition	10.8 W ($U_S = \text{Min}$, $T_{\text{amb}} = \text{Max}$, $DO_1 = \text{Max}$)
Test voltage	500 V DC
Test section	for one minute 500 V DC
Transmission medium	Copper
	FO

Supply

Supply voltage (DC)	24 V DC (redundant)
Supply voltage range	12 V DC ... 57 V DC
Power supply connection	via COMBICON, max. conductor cross section 1.5 mm ²
Residual ripple	3.6 V _{pp} (within the permitted voltage range)
Max. current consumption	1.6 A ($U_S = \text{Min}$, $T_{\text{amb}} = \text{Max}$, $DO_1 = \text{Max}$)
Typical current consumption	325 mA (at $U_S = 24$ V DC and 25 °C ambient temperature)
Current consumption	325 mA

Function

FL SWITCH 2214-2SFX PN - Industrial Ethernet Switch



1044030

<https://www.phoenixcontact.com/us/products/1044030>

Signal contact control voltage	typ. 24 V DC
--------------------------------	--------------

Connection data

Connection method	Push-in spring connection
Note on the connection method	Use only copper connecting cables providing the permitted temperature range (-40 °C ... 75 °C).
Conductor cross section, rigid	0.25 mm ² ... 1.5 mm ²
Conductor cross section, flexible	0.25 mm ² ... 1.5 mm ²
Conductor cross section AWG	24 ... 16
Stripping length	9 mm

Environmental and real-life conditions

Ambient conditions

Degree of protection	IP20
Ambient temperature (operation)	-40 °C ... 70 °C
Ambient temperature (storage/transport)	-40 °C ... 85 °C
Permissible humidity (operation)	10 % ... 95 % (non-condensing)
Permissible humidity (storage/transport)	10 % ... 95 % (non-condensing)
Shock (operation)	30g (EN 60068-2-27)
Vibration (operation)	in acc. with IEC 60068-2-6: 5g, 150 Hz
Air pressure (operation)	80 kPa ... 110 kPa up to 2000 m above mean sea level (Without derating)
Air pressure (storage/transport)	79 kPa ... 108 kPa up to 2000 m above mean sea level (Without derating)

Standards and regulations

Free from substances that could impair the application of coating	Yes
---	-----

Approval data

Shipbuilding approval	Tested in accordance with IEC 60945 and IACS E10
-----------------------	--

ATEX

Identification	<input type="checkbox"/> II 3 G Ex ec IIC T4 Gc
Certificate	DEMKO 16 ATEX 1709X

IECEX

Identification	Ex ec IIC T4 Gc
Certificate	IECEX ULD 16.0018 X

UL, USA/Canada

Identification	cULus
----------------	-------

UL Ex, USA / Canada

Identification	Class I, Division 2, Groups A, B, C, and D, T4
	Class I, Zone 2, AEx ec IIC T4
	Ex ec IIC T4 Gc X
Certificate	E366272

FL SWITCH 2214-2SFX PN - Industrial Ethernet Switch



1044030

<https://www.phoenixcontact.com/us/products/1044030>

Note	UL 60079-0 Ed. 6 / UL 60079-7 Ed. 5, CSA 22.2 No. 60079-0 Ed. 3 / CSA C22.2 No. 60079-7 Ed. 2
------	---

EAC Ex

Identification	2Ex e IIC T4 Gc X
Certificate	RU C-DE.HB49.B.00118/21

The following continue to apply for EAC Ex:

Identification	При монтаже использовать подходящий допущенный корпус со степенью защиты не ниже IP66.
	На корпусе/шкафу управления должна быть размещена предупреждающая надпись, запрещающая открывать корпус или шкаф во взрывоопасной зоне.
	Эксплуатация устройства допускается только при условии, что все оптические порты заняты подключенными устройствами или закрыты прилагаемыми заглушками.

CCC / China-Ex

Identification	Ex ec IIC T4 Gc
Certificate	2022122310115629

Corrosive gas test

Identification	ISA S71.04.2013 G3 Harsh Group A
----------------	----------------------------------

UKCA Ex (UKEX)

Identification	□ II 3 G Ex ec IIC T4 Gc
Certificate	PxCIMA22UKEX2702910X

DNV GL data

Temperature	B
Humidity	B
Vibration	A
EMC	B
Enclosure	Required protection according to the Rules shall be provided upon installation on board

EMC data

Conformance with EMC directives	EN 61000-6-2 EN 61000-4-2 (ESD) Criterion B
	EN 61000-6-2 EN 61000-4-3 (electromagnetic fields) Criterion A
	EN 61000-6-2 EN 61000-4-4 (EFT burst) Criterion A
	EN 61000-6-2 EN 61000-4-5 (surge) Criterion B
	EN 61000-6-2 EN 61000-4-6 (line noise immunity) Criterion A
	EN 61000-6-2 EN 61000-6-3 (noise emission) Class B
	EN 61000-6-2 EN 61000-6-3 (conducted emissions) Class B
Noise immunity	EN 61000-6-2
Electromagnetic compatibility	Conformance with EMC Directive 2014/30/EU
Noise emission	EN 61000-6-3

System properties

FL SWITCH 2214-2SFX PN - Industrial Ethernet Switch



1044030

<https://www.phoenixcontact.com/us/products/1044030>

Functionality

Basic functions

Store-and-forward switch, complies with IEEE 802.3

Signaling

Status display

LEDs: US1, US2 (power supply), Fail (alarm contact), 2 LEDs per Ethernet port (link/activity and speed), PROFINET status LEDs (BF, SF)

FL SWITCH 2214-2SFX PN - Industrial Ethernet Switch



1044030

<https://www.phoenixcontact.com/us/products/1044030>

Drawings

Dimensional drawing

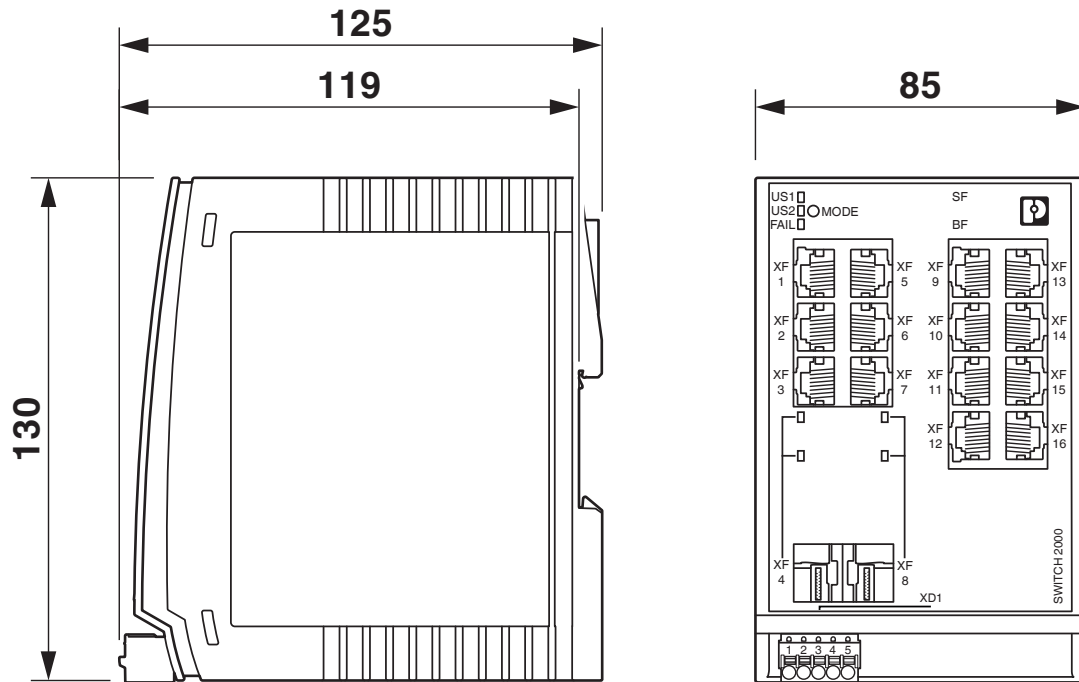

FL SWITCH 2214-2SFX PN - Industrial Ethernet Switch



1044030

<https://www.phoenixcontact.com/us/products/1044030>

Approvals



EAC

Approval ID: RU*-DE.*.B.00741/19



DNV GL

Approval ID: TAA00000YV



LR

Approval ID: LR22250919TA



NK

Approval ID: TA19464M



BV

Approval ID: 48146/A1 BV



UL Listed

Approval ID: FILE E 238705



cUL Listed

Approval ID: FILE E 238705



RINA

Approval ID: ELE162721XG



cUL Listed

Approval ID: FILE E 238705



UL Listed

Approval ID: FILE E 238705



IECEX

Approval ID: IECEX ULD 16.0018X



cUL Listed

Approval ID: FILE E 366272

FL SWITCH 2214-2SFX PN - Industrial Ethernet Switch



1044030

<https://www.phoenixcontact.com/us/products/1044030>



UL Listed

Approval ID: FILE E 366272



ATEX

Approval ID: DEMKO 16 ATEX 1709X

FL SWITCH 2214-2SFX PN - Industrial Ethernet Switch



1044030

<https://www.phoenixcontact.com/us/products/1044030>

Classifications

ECLASS

ECLASS-11.0	19170401
ECLASS-12.0	19170401
ECLASS-13.0	19170401

ETIM

ETIM 8.0	EC000734
----------	----------

UNSPSC

UNSPSC 21.0	43222600
-------------	----------

FL SWITCH 2214-2SFX PN - Industrial Ethernet Switch



1044030

<https://www.phoenixcontact.com/us/products/1044030>

Environmental Product Compliance

REACH SVHC	Lead 7439-92-1
China RoHS	Environmentally Friendly Use Period = 50 years
	For information on hazardous substances, refer to the manufacturer's declaration available under "Downloads"

FL SWITCH 2214-2SFX PN - Industrial Ethernet Switch



1044030

<https://www.phoenixcontact.com/us/products/1044030>

Accessories

SD FLASH 2GB - Program / configuration memory

2988162

<https://www.phoenixcontact.com/us/products/2988162>



Program and configuration memory, for extending the internal flash memory, pluggable, 2 GB.

FL NETWORK MANAGER BASIC - Network management software

2702889

<https://www.phoenixcontact.com/us/products/2702889>

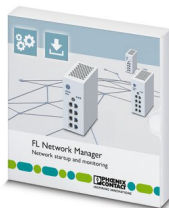

SNMP-based software for easy commissioning and monitoring of network components such as switches, routers, and WLAN access points

FL SWITCH 2214-2SFX PN - Industrial Ethernet Switch



1044030

<https://www.phoenixcontact.com/us/products/1044030>

FL DIN RA - DIN rail adapter

2891053

<https://www.phoenixcontact.com/us/products/2891053>

The FL DIN RA is installed in a standard, 19-inch rack (EIA-310-D, IEC 60297-3-100) to allow DIN rail mounted equipment to be rack mounted.

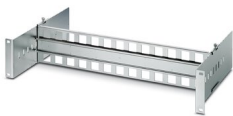

FL RJ45 PROTECT CAP - Dust protection

2832991

<https://www.phoenixcontact.com/us/products/2832991>

Dust protection caps for RJ45 socket

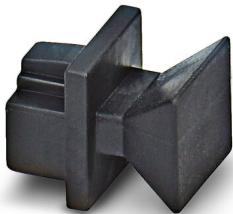

FL SWITCH 2214-2SFX PN - Industrial Ethernet Switch



1044030

<https://www.phoenixcontact.com/us/products/1044030>

E/NS 35 N - End clamp

0800886

<https://www.phoenixcontact.com/us/products/0800886>

End clamp, width: 9.5 mm, color: gray

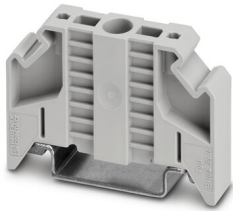

FK-MCP 1,5/ 5-ST-3,81GY35BD1-5 - PCB connector

1015782

<https://www.phoenixcontact.com/us/products/1015782>



PCB connector, nominal cross section: 1.5 mm², color: light grey, nominal current: 8 A, rated voltage (III/2): 160 V, contact surface: Tin, type of contact: Socket, number of potentials: 5, number of rows: 1, number of positions: 5, number of connections: 5, product range: FK-MCP 1,5/...-ST, pitch: 3.81 mm, connection method: Push-in spring connection, conductor/PCB connection direction: 0 °, number of solder pins per potential: 1, plug-in system: COMBICON MC 1,5, locking: without, mounting: without, type of packaging: packed in cardboard

FL SWITCH 2214-2SFX PN - Industrial Ethernet Switch



1044030

<https://www.phoenixcontact.com/us/products/1044030>

FL SFP FX - Media module

2891081

<https://www.phoenixcontact.com/us/products/2891081>



The small form-factor plug-in module provides a fiber optic interface with a data transmission speed of 100 Mbps with a wavelength of 1310 nm (long).

FL SFP FX SM - Media module

2891082

<https://www.phoenixcontact.com/us/products/2891082>



The small form-factor plug-in module provides a fiber optic interface with a data transmission speed of 100 Mbps with a wavelength of 1310 nm (long).

FL SWITCH 2214-2SFX PN - Industrial Ethernet Switch



1044030

<https://www.phoenixcontact.com/us/products/1044030>

FL SFP FE WDM20-SET - Media module

2702439

<https://www.phoenixcontact.com/us/products/2702439>

Fast Ethernet SFP WDM set for transmission up to a maximum of 20 km on a single fiber with a wavelength of 1310/1550 nm.



MCVW 1,5/ 5-ST-3,81GY7035BD2DO - PCB connector

1034096

<https://www.phoenixcontact.com/us/products/1034096>

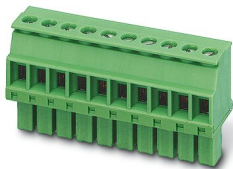

PCB connector, nominal cross section: 1.5 mm², color: light grey, nominal current: 8 A, rated voltage (III/2): 160 V, contact surface: Tin, type of contact: Socket, number of potentials: 5, number of rows: 1, number of positions: 5, number of connections: 5, product range: MCVW 1,5/..-ST, pitch: 3.81 mm, connection method: Screw connection with tension sleeve, screw head form: L Slotted, conductor/PCB connection direction: -90 °, number of solder pins per potential: 1, plug-in system: COMBICON MC 1,5, locking: without, mounting: without, type of packaging: packed in cardboard

FL SWITCH 2214-2SFX PN - Industrial Ethernet Switch



1044030

<https://www.phoenixcontact.com/us/products/1044030>

FL CAT5 PATCH 0,5 - Patch cable

2832263

<https://www.phoenixcontact.com/us/products/2832263>

Patch cable, CAT5, assembled, 0.5 m



FL CAT5 PATCH 1,0 - Patch cable

2832276

<https://www.phoenixcontact.com/us/products/2832276>

Patch cable, CAT5, assembled, 1 m



FL SWITCH 2214-2SFX PN - Industrial Ethernet Switch



1044030

<https://www.phoenixcontact.com/us/products/1044030>

FL CAT5 PATCH 2,0 - Patch cable

2832289

<https://www.phoenixcontact.com/us/products/2832289>

Patch cable, CAT5, assembled, 2 m



NBC-R4AC-R4AC-IE8A/.../... - Patch cable

1411854

<https://www.phoenixcontact.com/us/products/1411854>

Patch cable, degree of protection: IP20, number of positions: 8, 10 Gbps, CAT6_A, cable outlet: straight, Ethernet

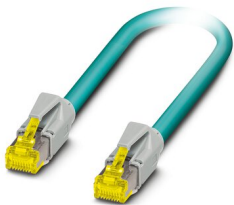

FL SWITCH 2214-2SFX PN - Industrial Ethernet Switch



1044030

<https://www.phoenixcontact.com/us/products/1044030>

NBC-R4AC/10G-R4AC/10G-94F/2,0 - Patch cable

1408360

<https://www.phoenixcontact.com/us/products/1408360>

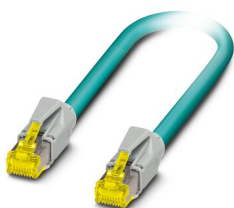

Patch cable, CAT6_A, 4-pair, shielded, connection not crossed (line), assembled at both ends with RJ45/IP20 connectors, outer sheath material: PUR, length: 2.0 m

NBC-R4AC/10G-R4AC/10G-94F/3,0 - Patch cable

1408365

<https://www.phoenixcontact.com/us/products/1408365>

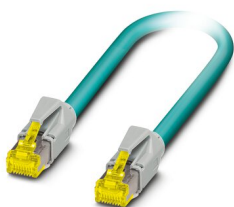

Patch cable, CAT6_A, 4-pair, shielded, connection not crossed (line), assembled at both ends with RJ45/IP20 connectors, outer sheath material: PUR, length: 3.0 m

FL SWITCH 2214-2SFX PN - Industrial Ethernet Switch



1044030

<https://www.phoenixcontact.com/us/products/1044030>

NBC-R4AC/1,0-93B/R4AC - Patch cable

1408968

<https://www.phoenixcontact.com/us/products/1408968>



Patch cable, degree of protection: IP20, cable length: 1 m, number of positions: 4, 100 Mbps, CAT5, material: PA 6.6, PROFINET

NBC-R4AC/2,0-93B/R4AC - Patch cable

1408969

<https://www.phoenixcontact.com/us/products/1408969>



Patch cable, degree of protection: IP20, cable length: 2 m, number of positions: 4, 100 Mbps, CAT5, material: PA 6.6, PROFINET

FL SWITCH 2214-2SFX PN - Industrial Ethernet Switch



1044030

<https://www.phoenixcontact.com/us/products/1044030>

NBC-R4AC/5,0-93B/R4AC - Patch cable

1408970

<https://www.phoenixcontact.com/us/products/1408970>



Patch cable, degree of protection: IP20, cable length: 5 m, number of positions: 4, 100 Mbps, CAT5, material: PA 6.6, PROFINET

FOC-LC:PA-SC:PA-OM2:D01/1 - FO patch cable

1115607

<https://www.phoenixcontact.com/us/products/1115607>

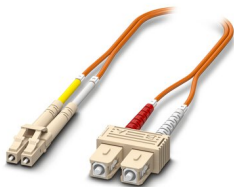

Multi-mode OM2 duplex jumper, LC-SC, UPC polishing, length 1 m

FL SWITCH 2214-2SFX PN - Industrial Ethernet Switch



1044030

<https://www.phoenixcontact.com/us/products/1044030>

FOC-LC:PA-SC:PA-OM2:D01/2 - FO patch cable

1115605

<https://www.phoenixcontact.com/us/products/1115605>

Multi-mode OM2 duplex jumper, LC-SC, UPC polishing, length 2 m

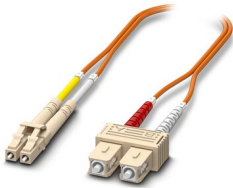

FOC-LC:PA-LC:PA-OM2:D01/1 - FO patch cable

1115633

<https://www.phoenixcontact.com/us/products/1115633>

Multi-mode OM2 duplex jumper, LC-LC, UPC polishing, length 1 m

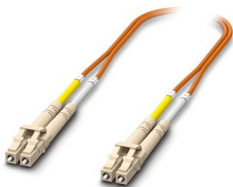

FL SWITCH 2214-2SFX PN - Industrial Ethernet Switch



1044030

<https://www.phoenixcontact.com/us/products/1044030>

FOC-LC:PA-LC:PA-OM2:D01/2 - FO patch cable

1115634

<https://www.phoenixcontact.com/us/products/1115634>

Multi-mode OM2 duplex jumper, LC-LC, UPC polishing, length 2 m

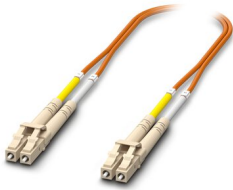

FOC-LC:PA-ST:PA-OM2:D01/1 - Fiber optic cable

1115588

<https://www.phoenixcontact.com/us/products/1115588>

Multi-mode OM2 duplex jumper, LC-ST, UPC polishing, length 1 m

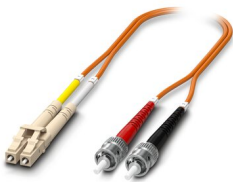

FL SWITCH 2214-2SFX PN - Industrial Ethernet Switch



1044030

<https://www.phoenixcontact.com/us/products/1044030>

FOC-LC:PA-ST:PA-OM2:D01/2 - Fiber optic cable

1115587

<https://www.phoenixcontact.com/us/products/1115587>

Multi-mode OM2 duplex jumper, LC-ST, UPC polishing, length 2 m

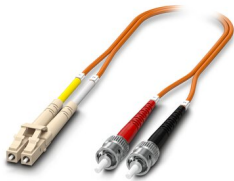

FOC-LC:PA-SC:PA-OM4:D01/1 - FO patch cable

1115601

<https://www.phoenixcontact.com/us/products/1115601>

Multi-mode OM4 duplex jumper, LC-SC, UPC polishing, length 1 m

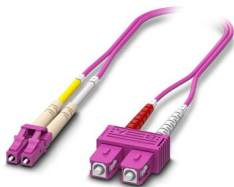

FL SWITCH 2214-2SFX PN - Industrial Ethernet Switch



1044030

<https://www.phoenixcontact.com/us/products/1044030>

FOC-LC:PA-SC:PA-OM4:D01/2 - FO patch cable

1115600

<https://www.phoenixcontact.com/us/products/1115600>

Multi-mode OM4 duplex jumper, LC-SC, UPC polishing, length 2 m

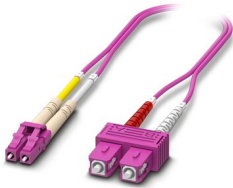

FOC-LC:PA-LC:PA-OM4:D01/1 - FO patch cable

1115625

<https://www.phoenixcontact.com/us/products/1115625>

Multi-mode OM4 duplex jumper, LC-LC, UPC polishing, length 1 m

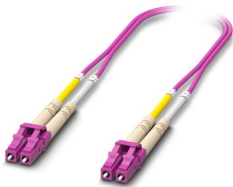

FL SWITCH 2214-2SFX PN - Industrial Ethernet Switch



1044030

<https://www.phoenixcontact.com/us/products/1044030>

FOC-LC:PA-LC:PA-OM4:D01/2 - FO patch cable

1115624

<https://www.phoenixcontact.com/us/products/1115624>

Multi-mode OM4 duplex jumper, LC-LC, UPC polishing, length 2 m

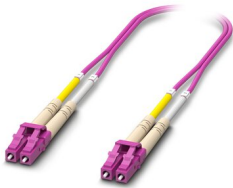

FOC-LC:PA-LC:PA-OS2:D01/1 - FO patch cable

1115636

<https://www.phoenixcontact.com/us/products/1115636>

Single-mode OS2 duplex jumper, LC-LC, UPC polishing, length 1 m



FL SWITCH 2214-2SFX PN - Industrial Ethernet Switch



1044030

<https://www.phoenixcontact.com/us/products/1044030>

FOC-LC:PA-LC:PA-OS2:D01/2 - FO patch cable

1115629

<https://www.phoenixcontact.com/us/products/1115629>

Single-mode OS2 duplex jumper, LC-LC, UPC polishing, length 2 m

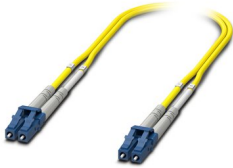

FOC-LC:PA-ST:PA-OS2:D01/1 - FO patch cable

1115596

<https://www.phoenixcontact.com/us/products/1115596>

Single-mode OS2 duplex jumper, LC-ST, UPC polishing, length 1 m

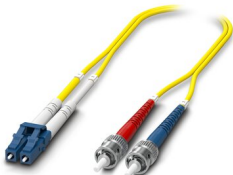

FL SWITCH 2214-2SFX PN - Industrial Ethernet Switch



1044030

<https://www.phoenixcontact.com/us/products/1044030>

FOC-LC:PA-ST:PA-OS2:D01/2 - FO patch cable

1115595

<https://www.phoenixcontact.com/us/products/1115595>

Single-mode OS2 duplex jumper, LC-ST, UPC polishing, length 2 m

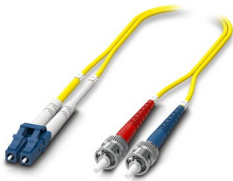

FOC-LC:PA-SC:PA-OS2:D01/1 - FO patch cable

1115618

<https://www.phoenixcontact.com/us/products/1115618>

Single-mode OS2 duplex jumper, LC-SC, UPC polishing, length 1 m

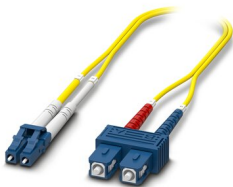

FL SWITCH 2214-2SFX PN - Industrial Ethernet Switch



1044030

<https://www.phoenixcontact.com/us/products/1044030>

FOC-LC:PA-SC:PA-OS2:D01/2 - FO patch cable

1115617

<https://www.phoenixcontact.com/us/products/1115617>

Single-mode OS2 duplex jumper, LC-SC, UPC polishing, length 2 m

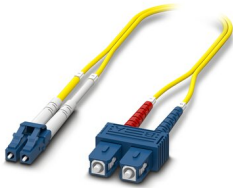

VS-08-RJ45-5-Q/IP20 - RJ45 connector

1656725

<https://www.phoenixcontact.com/us/products/1656725>



RJ45 connector, design: RJ45, degree of protection: IP20, number of positions: 8, 1 Gbps, CAT5, material: Plastic, connection method: Insulation displacement connection, connection cross section: AWG 26- 23, cable outlet: straight, color: traffic grey A RAL 7042, Ethernet

Phoenix Contact 2023 © - all rights reserved
<https://www.phoenixcontact.com>

Phoenix Contact USA
586 Fulling Mill Road
Middletown, PA 17057, United States
(+717) 944-1300
info@phoenixcon.com