

May.1.2023 Copyright 2023 HIROSE ELECTRIC CO., LTD. All Rights Reserved.
In case of consideration for using Automotive equipment / device which demand high reliability, kindly contact our sales window correspondents.

1> FIGURE-1 CONTACT No. MARKING (10:1)

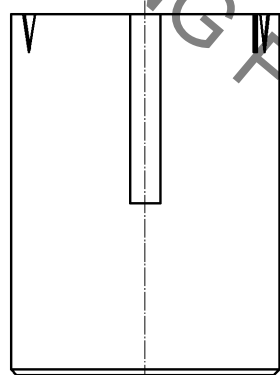

MATING FIGURE

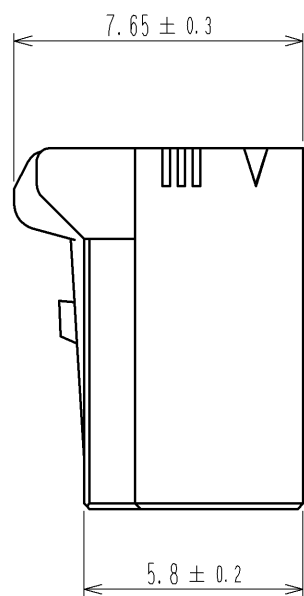
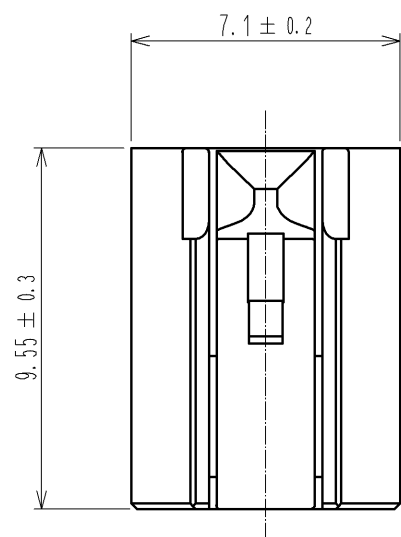
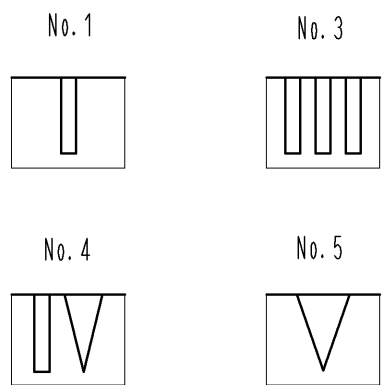
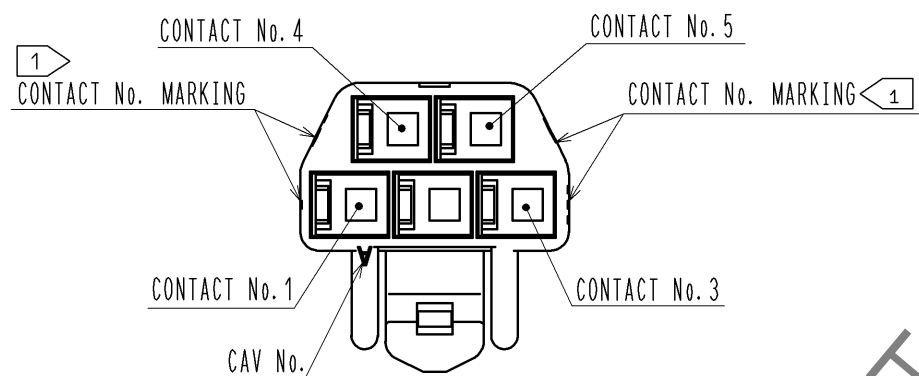
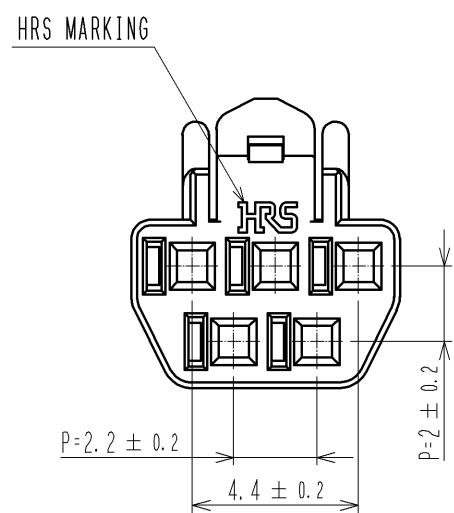
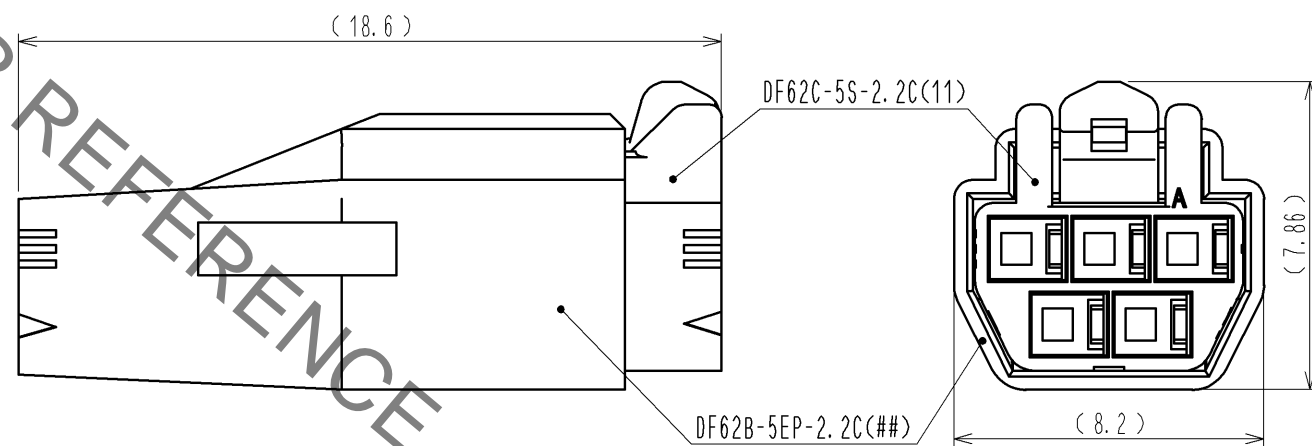

NOTE. 1> MARKINGS AT THE INDICATED POSITIONS ARE CONTACT NO. MARKING. AND SHAPES ARE SHOWN IN FIGURE-1.
2. PER PACK : 100 PIECES.
3. THE DIMENSIONS IN PARENTHESIS ARE FOR REFERENCE.

NO.	MATERIAL	FINISH . REMARKS	NO.	MATERIAL	FINISH . REMARKS
			1	PBT	UL94V-0 (BLACK)
UNITS	mm	SCALE	DESCRIPTION OF REVISIONS		
		5 : 1	DESIGNED	CHECKED	DATE
HIROSE ELECTRIC CO., LTD.		APPROVED : KI. AKIYAMA	13. 09. 17	DRAWING NO. EDC3-351973-01	
		CHECED : OM. MIYAMOTO	13. 09. 13	PART NO. DF62C-5S-2.2C(11)	
		DESIGNED : TH. YOSHIZAWA	13. 09. 13	CODE NO. CL544-0568-2-11	
		DRAWN : MI. SAKIMURA	13. 09. 09		