

RKC2 Series Microminiature SMT Top Actuated Tact Switch

NEW



Features/Benefits

- 1.7 mm height, 3.5 x 2.7 mm size
- SMT termination
- Hard actuator
- 180, 250, 350 & 500 gf actuation forces
- 100k to 200k cycles

Typical Applications

- Automotive keyfob
- High-end consumer
- Health & medical devices

Tactile Switches

Specifications

FUNCTION: momentary action
 CONTACT ARRANGEMENT: 1 make contact = SPST N.O.
 TERMINALS: SMT termination
 TRAVEL: 0.15 ± 0.1 mm

Mechanical

Product Description	Life Cycles
RKC2SJM170SMTR LFS	200,000
RKC2SJK170SMTR LFS	200,000
RKC2SJR170SMTR LFS	200,000
RKC2SJF170SMTR LFS	100,000
RKC2SJFG170SMTR LFS	200,000

Electrical

MAXIMUM VOLTAGE: 12 VDC
 MAXIMUM CURRENT DC: 20 mA
 CONTACT RESISTANCE: 100 mΩ
 INSULATION RESISTANCE: 100 MΩ min.
 DIELECTRIC STRENGTH: 250 VA C (1 minute)
 BOUNCE TIME: ≤ 10 ms

Environmental

OPERATING TEMPERATURE: -40°C to 85°C

Process

SOLDERING: This component is suited to the following methods:
 Infrared Reflow Soldering in accordance with IEC61760-1

Packaging

4,000 pieces per reel

How To Order

Our easy build-a-switch concept allows you to mix and match options to create the switch you need. To order, select desired option from each category and place it in the appropriate box.

For any part number different from those listed below, please consult your local representative.

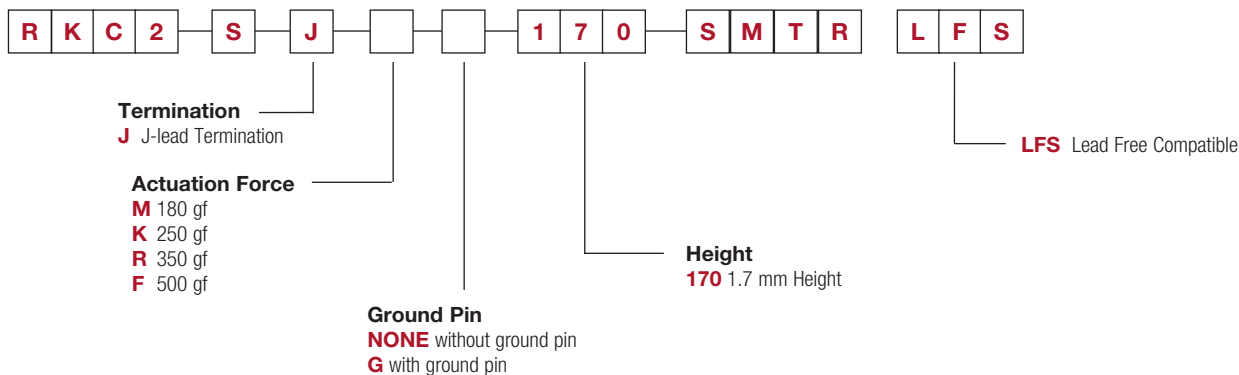

NEW

RKC2 Series Microminiature SMT Top Actuated Tact Switch

Standard Version without Ground Pin

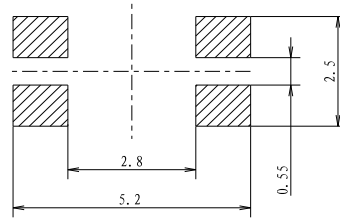
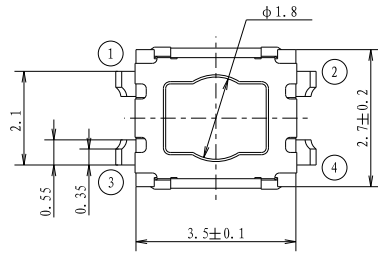

P. C. B LAND DIMENSION

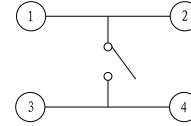
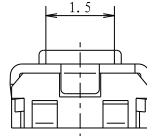
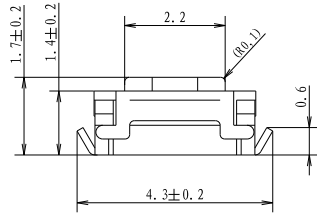

CIRCUIT DIAGRAM

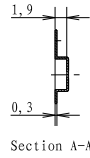
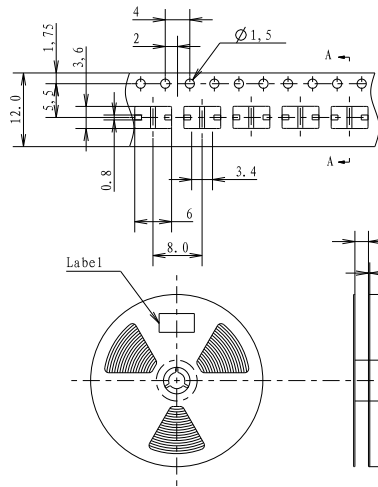

Section A-A

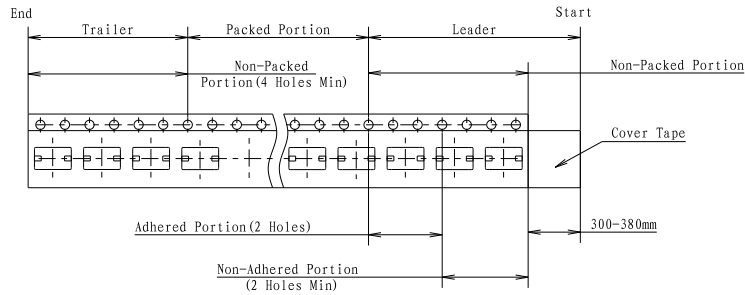
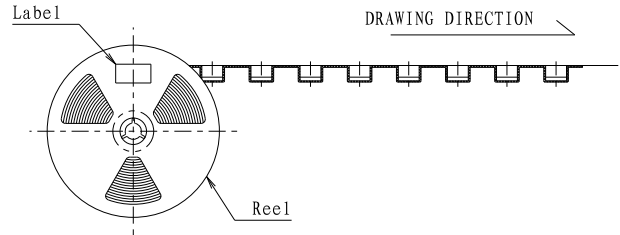
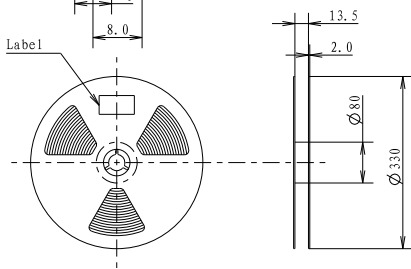

NOTE

1. 4K pcs SWITCHES PER 1 REEL
2. GENERAL TOLERANCE : 0.3mm

RKC2 Series Microminiature SMT Top Actuated Tact Switch

NEW

Version with Ground Pin

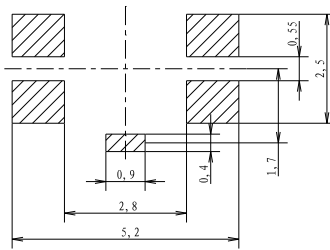
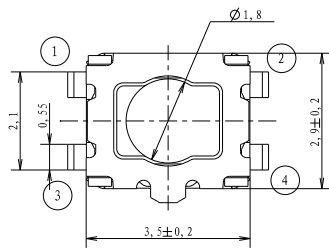

PCB LAYOUT

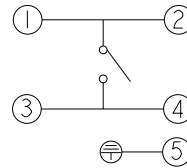
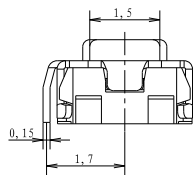
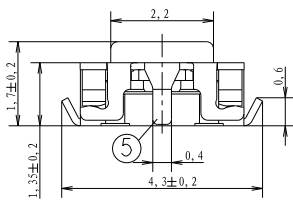

CIRCUIT DIAGRAM

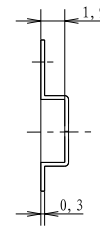
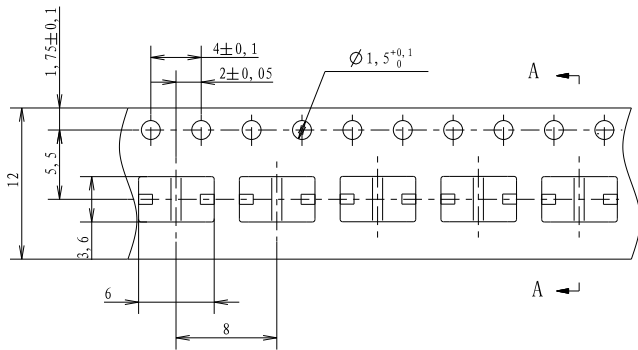

Section A-A

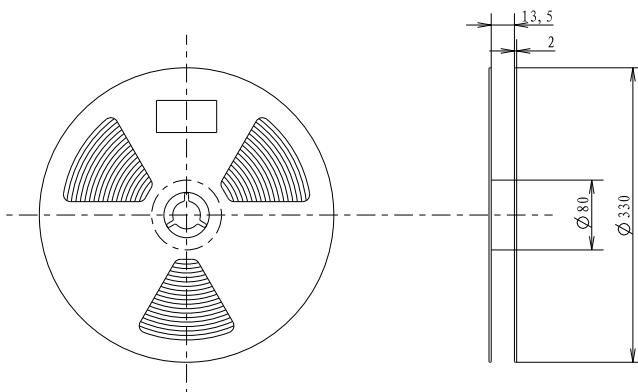

NOTE

1. 4K pcs SWITCHES PER 1 REEL
2. GENERAL TOLERANCE : $\pm 0.3\text{mm}$

Tactile Switches

B