

IGBT/SiC Diode Co-pack

V_{CES}	=	1200 V
I_{CM}	=	100 A
$V_{CE(SAT)}$	=	1.9 V

Features

- Optimal Punch Through (OPT) technology
- SiC freewheeling diode
- Positive temperature coefficient for easy paralleling
- Extremely fast switching speeds
- Temperature independent switching behavior of SiC rectifier
- Best RBSOA/SCSOA capability in the industry
- High junction temperature
- Industry standard packaging

Package

- RoHS Compliant

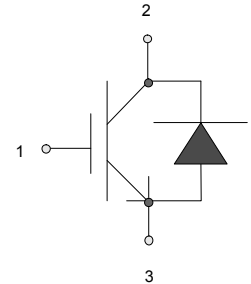
SOT – 227
Advantages

- Industry's highest switching speeds
- High temperature operation
- Improved circuit efficiency
- Low switching losses

Applications

- Solar Inverters
- Aerospace Actuators
- Server Power Supplies
- Resonant Inverters > 100 kHz
- Inductive Heating
- Electronic Welders

Maximum Ratings at $T_j = 175\text{ }^\circ\text{C}$, unless otherwise specified

Parameter	Symbol	Conditions	Values	Unit
IGBT				
Collector-Emitter Voltage	V_{CES}		1200	V
DC-Collector Current	I_C	$T_C \leq 130\text{ }^\circ\text{C}$	100	A
Peak Collector Current	I_{CM}	Limited by T_{vjmax}	200	A
Gate Emitter Peak Voltage	V_{GES}		± 20	V
IGBT Short Circuit SOA	t_{psc}	$V_{CC} = 900\text{ V}$, $V_{CEM} \leq 1200\text{ V}$ $V_{GE} \leq 15\text{ V}$, $T_{vj} \leq 125\text{ }^\circ\text{C}$	10	μs
Operating Temperature	T_{vj}		-40 to +175	$^\circ\text{C}$
Storage Temperature	T_{stg}		-40 to +175	$^\circ\text{C}$
Isolation Voltage	V_{ISOL}	$I_{SOL} < 1\text{ mA}$, 50/60 Hz, $t = 1\text{ s}$	3000	V

Free-wheeling Silicon Carbide diode

DC-Forward Current	I_F	$T_C \leq 130\text{ }^\circ\text{C}$	100	A
Non Repetitive Peak Forward Current	I_{FM}	$T_C = 25\text{ }^\circ\text{C}$, $t_p = 10\text{ }\mu\text{s}$	tbd	A
Surge Non Repetitive Forward Current	$I_{F,SM}$	$t_p = 10\text{ ms}$, half sine, $T_C = 25\text{ }^\circ\text{C}$	tbd	A

Thermal Characteristics

Thermal resistance, junction - case	R_{thJC}	IGBT	0.08	$^\circ\text{C/W}$
Thermal resistance, junction - case	R_{thJC}	SiC Diode	0.53	$^\circ\text{C/W}$

Mechanical Properties

		Values		
		min.	typ.	max.
Mounting Torque	M_d		1.5	Nm
Terminal Connection Torque		1.3		Nm
Weight			29	g
Case Color		Black		
Dimensions		38 x 25.4 x 12 mm		

Electrical Characteristics at $T_j = 175\text{ }^\circ\text{C}$, unless otherwise specified

Parameter	Symbol	Conditions	Values			Unit
			min.	typ.	max.	
IGBT						
Gate Threshold Voltage	$V_{GE(th)}$	$V_{GE} = V_{CE}, I_C = 4\text{ mA}, T_j = 25\text{ }^\circ\text{C}$	5	6.2	7	V
Collector-Emitter Leakage Current	$I_{CES,25}$	$V_{GE} = 0\text{ V}, V_{CE} = V_{CES}, T_j = 25\text{ }^\circ\text{C}$		0.10	1	mA
	$I_{CES,175}$	$V_{GE} = 0\text{ V}, V_{CE} = V_{CES}, T_j = 175\text{ }^\circ\text{C}$		3.15		mA
Gate-Leakage Current	I_{GES}	$V_{CE} = 0\text{ V}, V_{GE} = 20\text{ V}, T_j = 175\text{ }^\circ\text{C}$	-400		400	nA
Collector-Emitter Threshold Voltage	$V_{GE(TO)}$	$T_j = 25\text{ }^\circ\text{C}$		1.1		V
Collector-Emitter Slope Resistance	$R_{CE,25}$	$V_{GE} = 15\text{ V}, T_j = 25\text{ }^\circ\text{C}$		7.9		m Ω
	$R_{CE,175}$	$V_{GE} = 15\text{ V}, T_j = 175\text{ }^\circ\text{C}$		11.4		m Ω
Collector-Emitter Saturation Voltage	$V_{CE(SAT)}$	$I_C = 100\text{ A}, V_{GE} = 15\text{ V}, T_j = 25\text{ }^\circ\text{C} (175\text{ }^\circ\text{C})$		1.9 (2.2)		V
Input Capacitance	C_{ies}	$V_{GE} = 0\text{ V}, V_{CE} = 25\text{ V}, f = 1\text{ MHz}, T_j = 150\text{ }^\circ\text{C}$		8.55		nF
Output Capacitance	C_{oes}			1.39		nF
Reverse Transfer Capacitance	C_{res}			0.25		nF
Internal Gate Resistance	R_{Gint}			2		Ω
Gate Charge	Q_G	$V_{CC} = 750\text{ V}, I_C = 100\text{ A}, V_{GE} = -8.15\text{ V}, T_j = 25\text{ }^\circ\text{C} (125\text{ }^\circ\text{C})$		900 (900)		nC
Module Lead Resistance	R_{mod}	$T_c = 25\text{ }^\circ\text{C} (175\text{ }^\circ\text{C})$		tbid		m Ω
Reverse Bias Safe Operating Area	RBSOA	$T_j = 175\text{ }^\circ\text{C}, R_{\theta} = 56\text{ }^\circ\text{C/W}, V_{CC} = 1200\text{ V}, V_{GE} = 15\text{ V}$		150		A
Short Circuit Current	I_{sc}	$T_j = 175\text{ }^\circ\text{C}, R_{\theta} = 56\text{ }^\circ\text{C/W}, V_{CC} = 900\text{ V}, V_{GE} = \pm 15\text{ V}$		470		A
Short Circuit Duration	t_{sc}				10	
Rise Time	t_r	$V_{CC} = 800\text{ V}, I_C = 100\text{ A}, R_{gon} = R_{goff} = 10\text{ }^\circ\Omega, V_{GE(on)} = 15\text{ V}, V_{GE(off)} = -8\text{ V}, L_S = 0.8\text{ }^\mu\text{H}, T_j = 25\text{ }^\circ\text{C}$		254		ns
Fall Time	t_f			153		ns
Turn On Delay Time	$t_{d(on)}$			244		ns
Turn Off Delay Time	$t_{d(off)}$			488		ns
Turn-On Energy Loss Per Pulse	E_{on}			14.2		mJ
Turn-Off Energy Loss Per Pulse	E_{off}			15.7		mJ
Rise Time	t_r	$V_{CC} = 800\text{ V}, I_C = 100\text{ A}, R_{gon} = R_{goff} = 10\text{ }^\circ\Omega, V_{GE(on)} = 15\text{ V}, V_{GE(off)} = -8\text{ V}, L_S = 0.8\text{ }^\mu\text{H}, T_j = 175\text{ }^\circ\text{C}$		211		ns
Fall Time	t_f			172		ns
Turn On Delay Time	$t_{d(on)}$			240		ns
Turn Off Delay Time	$t_{d(off)}$			636		ns
Turn-On Energy Loss Per Pulse	E_{on}			11.1		mJ
Turn-Off Energy Loss Per Pulse	E_{off}			21.8		mJ
Free-wheeling Silicon Carbide Diode						
Forward Voltage	V_F	$I_F = 100\text{ A}, V_{GE} = 0\text{ V}, T_j = 25\text{ }^\circ\text{C} (175\text{ }^\circ\text{C})$		2.08 (3.5)		V
Threshold Voltage at Diode	$V_{D(TO)}$	$T_j = 25\text{ }^\circ\text{C}$		0.8		V
Peak Reverse Recovery Current	I_{rrm}	$I_F = 100\text{ A}, V_{GE} = 0\text{ V}, V_R = 800\text{ V}, -di_F/dt = 625\text{ A}/\mu\text{s}, T_j = 175\text{ }^\circ\text{C}$		10		A
Reverse Recovery Time	t_{rr}				100	
Rise Time	t_r	$V_{CC} = 800\text{ V}, I_C = 100\text{ A}, R_{gon} = R_{goff} = 10\text{ }^\circ\Omega, V_{GE(on)} = 15\text{ V}, V_{GE(off)} = -8\text{ V}, L_S = 0.8\text{ }^\mu\text{H}, T_j = 25\text{ }^\circ\text{C}$		148		ns
Fall Time	t_f			336		ns
Turn-On Energy Loss Per Pulse	E_{on}			218		μJ
Turn-Off Energy Loss Per Pulse	E_{off}			113		μJ
Reverse Recovery Charge	Q_{rr}			730		nC
Rise Time	t_r			178		ns
Fall Time	t_f	$V_{CC} = 800\text{ V}, I_C = 100\text{ A}, R_{gon} = R_{goff} = 10\text{ }^\circ\Omega, V_{GE(on)} = 15\text{ V}, V_{GE(off)} = -8\text{ V}, L_S = 0.8\text{ }^\mu\text{H}, T_j = 175\text{ }^\circ\text{C}$		268		ns
Turn-On Energy Loss Per Pulse	E_{on}			23		μJ
Turn-Off Energy Loss Per Pulse	E_{off}			334		μJ
Reverse Recovery Charge	Q_{rr}			480		nC

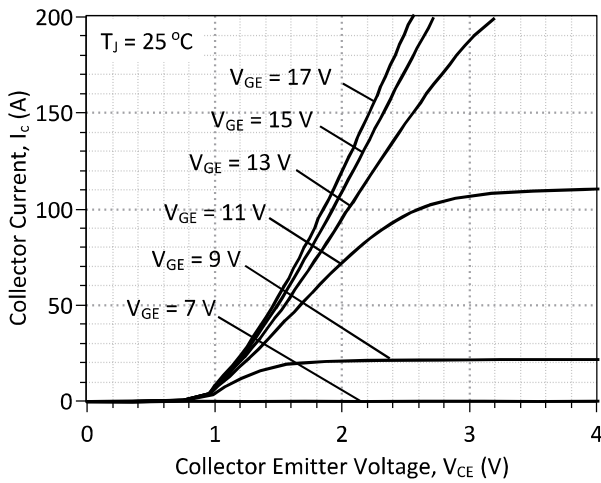

Figure 1: Typical Output Characteristics at 25 °C

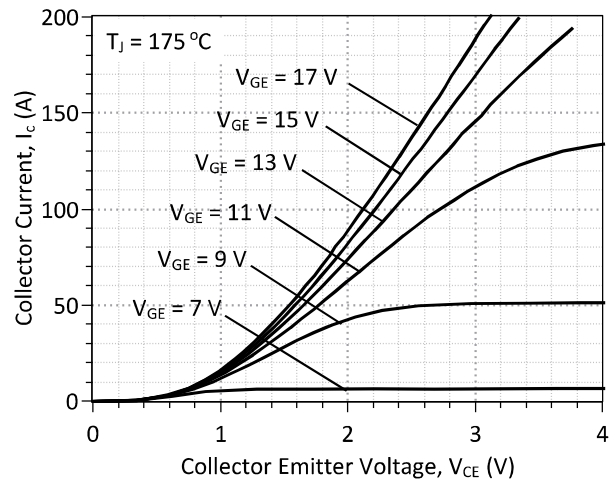

Figure 2: Typical Output Characteristics at 175 °C

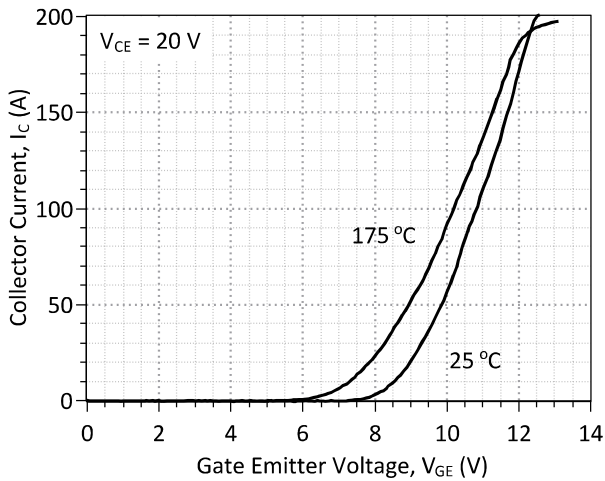

Figure 3: Typical Transfer Characteristics

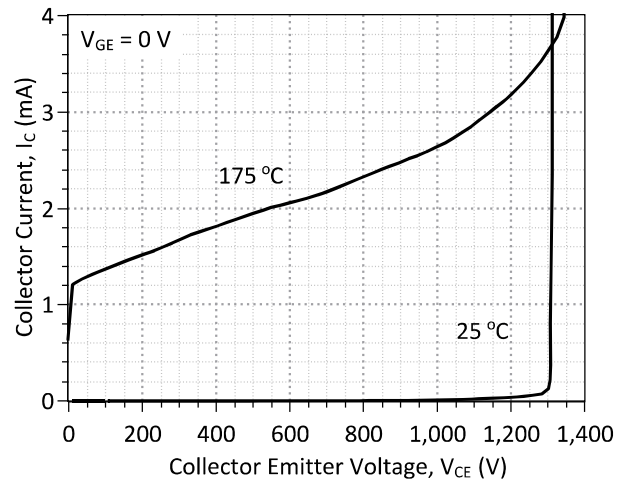

Figure 4: Typical Blocking Characteristics

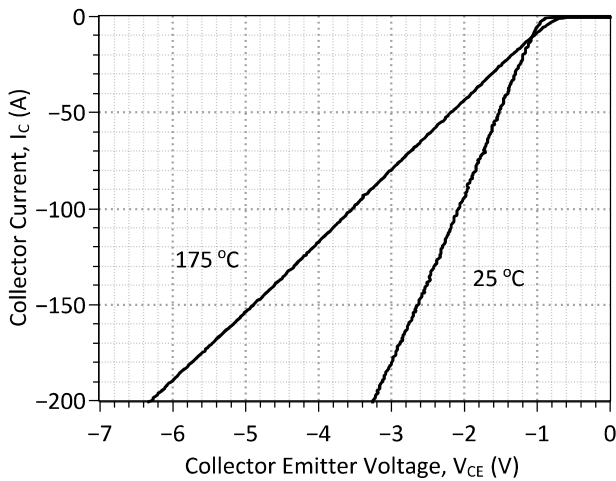

Figure 5: Typical FWD Forward Characteristics

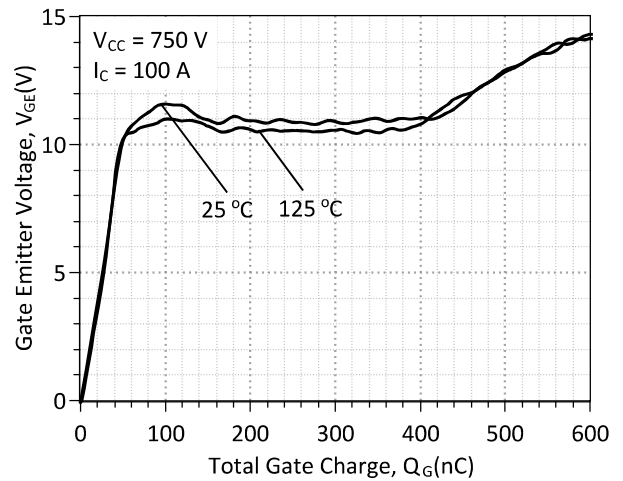

Figure 6: Typical Turn On Gate Charge

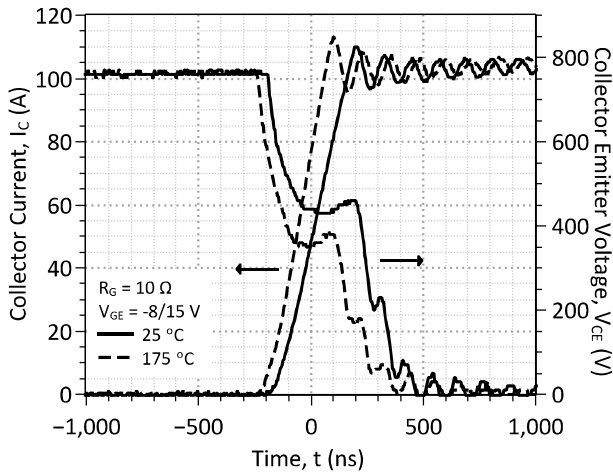

Figure 7: Typical Hard-Switched IGBT Turn On Waveforms

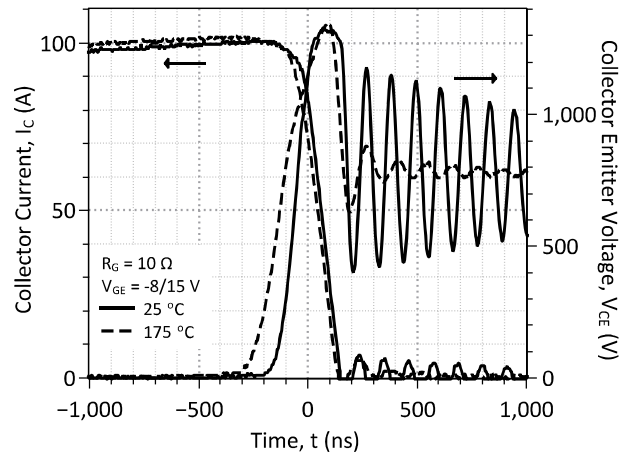

Figure 8: Typical Hard-Switched IGBT Turn Off Waveforms

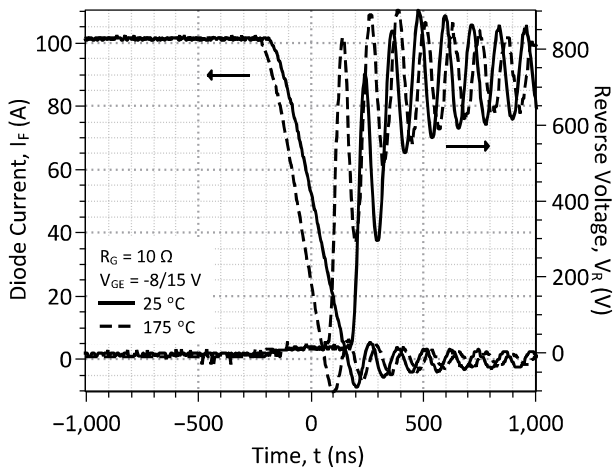

Figure 9: Typical Hard-Switched Free-wheeling SiC Diode Turn Off Waveforms

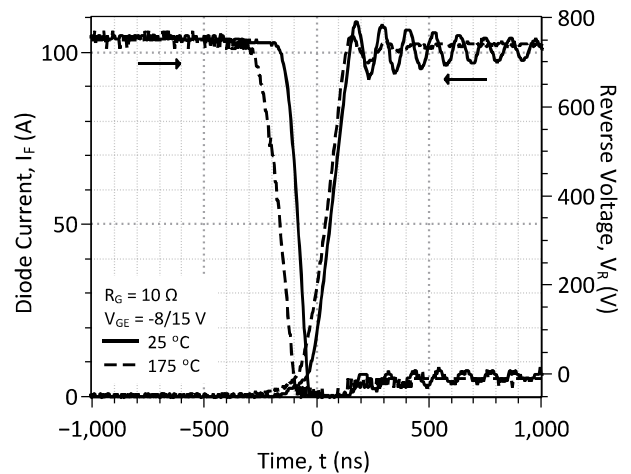

Figure 10: Typical Hard-Switched Free-wheeling SiC Diode Turn On Waveforms

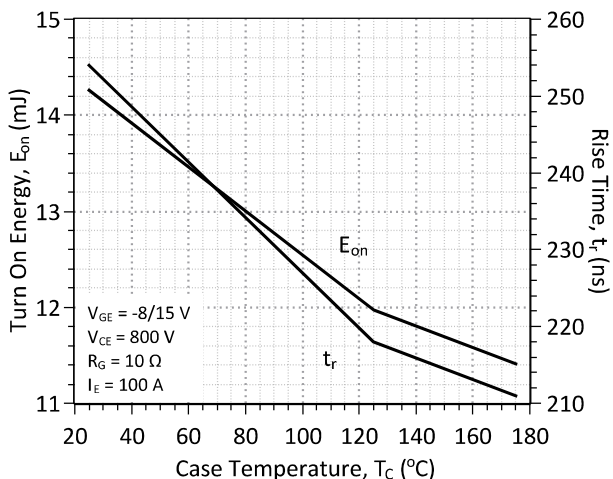

Figure 11: Typical Module Energy Losses and Switching Times at IGBT Turn On vs. Temperature

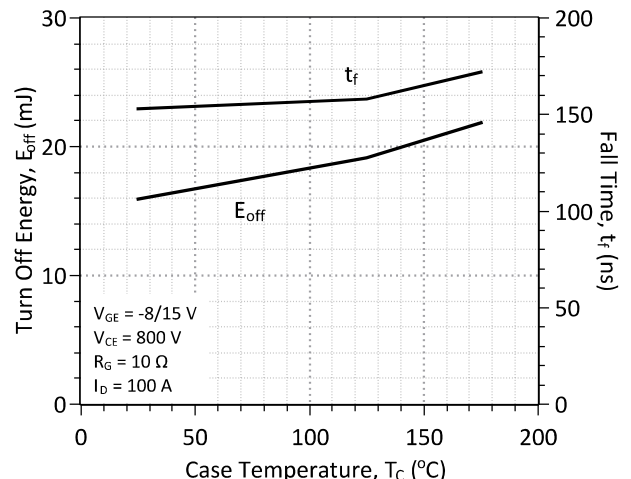

Figure 12: Typical Module Energy Losses and Switching Times at IGBT Turn Off vs. Temperature

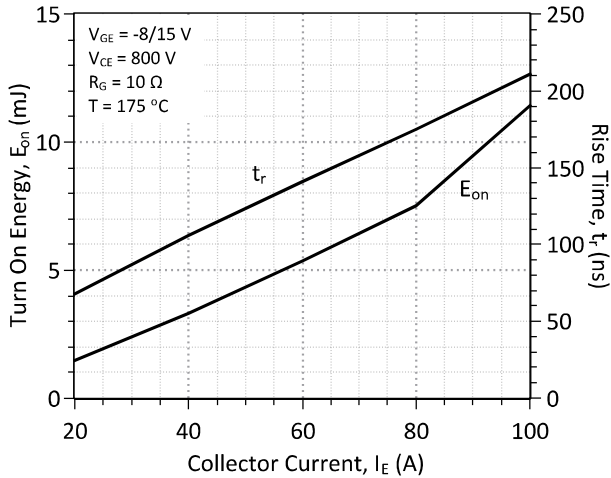

Figure 13: Typical Module Energy Losses and Switching Times at IGBT Turn On vs. Current

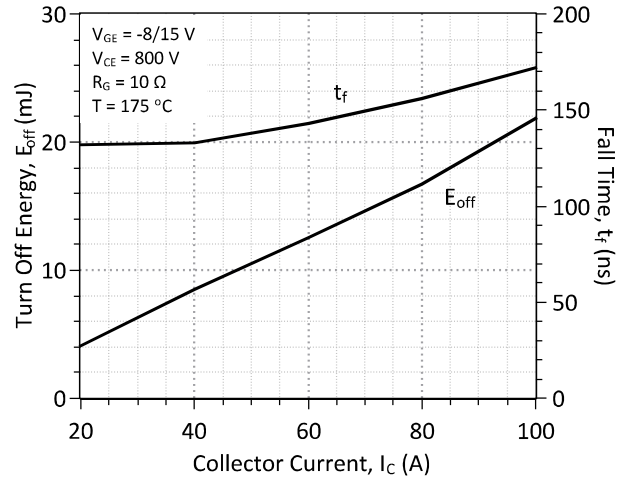

Figure 14: Typical Module Energy Losses and Switching Times at IGBT Turn Off vs. Current

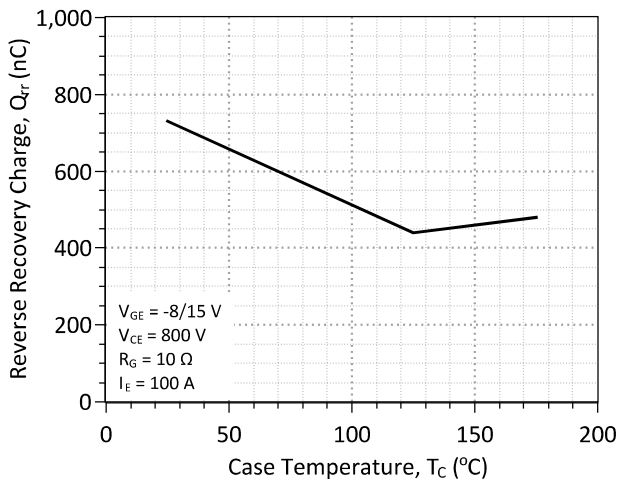

Figure 15: Typical Hard-Switched Reverse Recovery Charge vs. Temperature

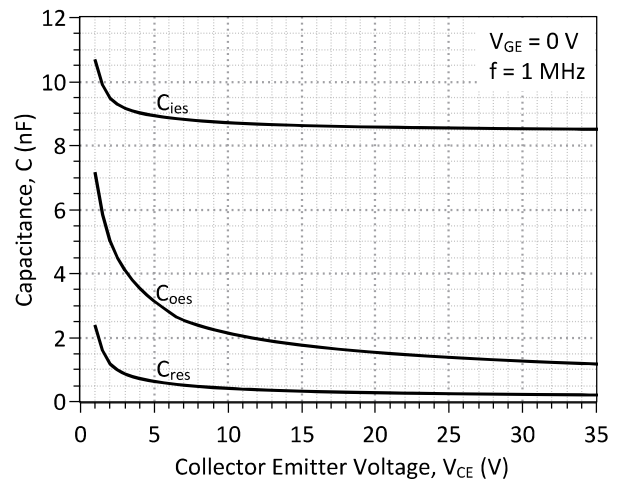
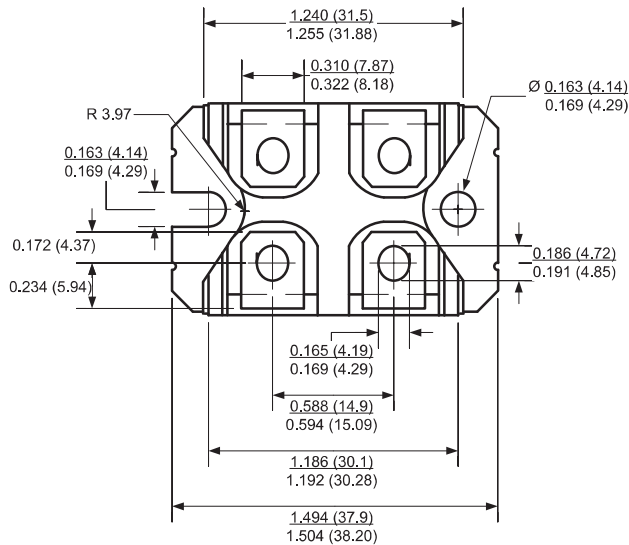
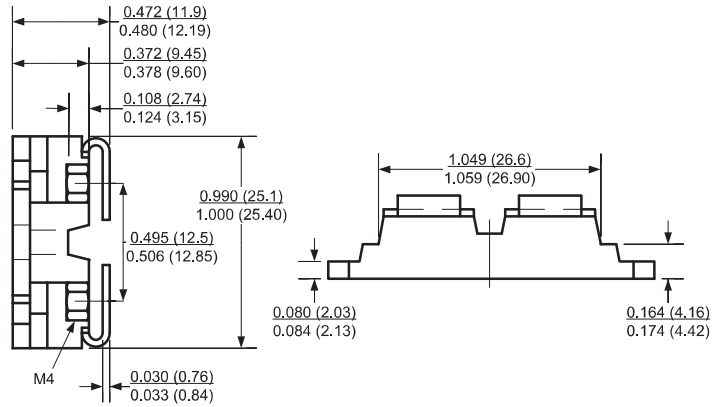

Figure 16: Typical C-V Characteristics

Package Dimensions:
SOT-227

PACKAGE OUTLINE

NOTE

1. CONTROLLED DIMENSION IS INCH. DIMENSION IN BRACKET IS MILLIMETER.
2. DIMENSIONS DO NOT INCLUDE END FLASH, MOLD FLASH, MATERIAL PROTRUSIONS

Revision History			
Date	Revision	Comments	Supersedes
2013/02/08	2	Updated Electrical Characteristics	
2012/07/30	1	Second generation release	GA100XCP12-227
2011/01/06	0	Initial release	

Published by
GeneSiC Semiconductor, Inc.
43670 Trade Center Place Suite 155
Dulles, VA 20166

GeneSiC Semiconductor, Inc. reserves right to make changes to the product specifications and data in this document without notice.

GeneSiC disclaims all and any warranty and liability arising out of use or application of any product. No license, express or implied to any intellectual property rights is granted by this document.

Unless otherwise expressly indicated, GeneSiC products are not designed, tested or authorized for use in life-saving, medical, aircraft navigation, communication, air traffic control and weapons systems, nor in applications where their failure may result in death, personal injury and/or property damage.