

THIS COPY IS PROVIDED ON A RESTRICTED BASIS AND IS NOT TO BE USED IN ANY WAY DETRIMENTAL TO THE INTERESTS OF PANDUIT CORP.

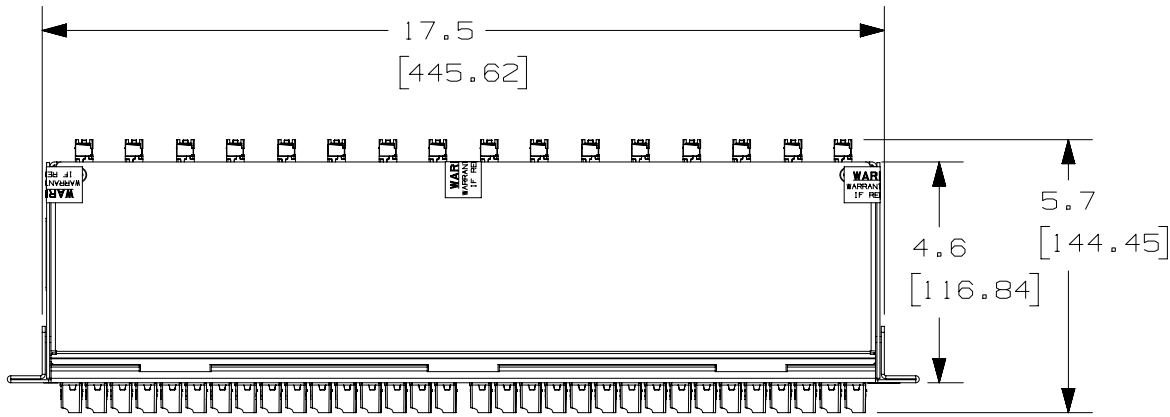

**NOTES:**

1. SEE CURRENT CATALOG FOR PART NUMBER SUFFIXES TO INDICATE COLOR AND/OR PACKAGE QUANTITIES.
2. SEE CATALOG FOR A COMPLETE LIST OF PARTS APPLICABLE FOR USE WITH THIS PRODUCT.
3. REFERENCE TIA-568-C.0. FOR DETAILS ON METHOD A CONNECTIVITY.
4. MATERIALS:  
 A. BOX AND LID: ALUMINUM  
 B. ADAPTERS: COMPOSITE PLASTIC
5. CASSETTE MODULE WEIGHT: 33.1oz [940.4gr]
6. DIMENSIONS IN BRACKETS ARE METRIC
7. ALL MATERIALS AND COMPONENTS USED MEET THE MATERIAL RESTRICTIONS OF RoHS, (EUROPEAN DIRECTIVE 2011/65/EC ON THE RESTRICTIONS OF HAZARDOUS SUBSTANCES) AS PROPOSED BY THE RoHS TECHNICAL ADAPTATION COMMITTEE.

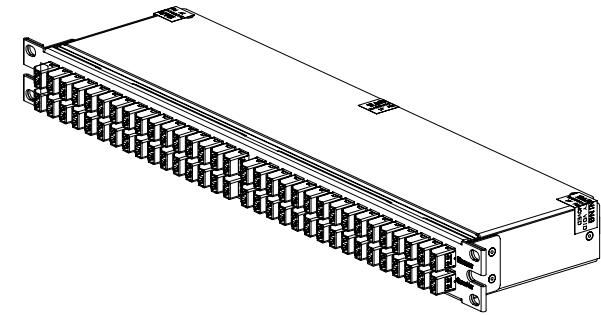
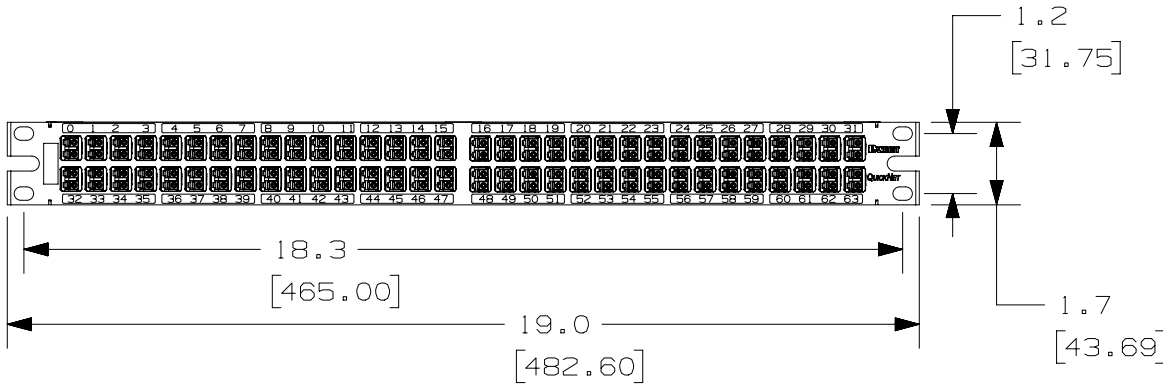

ISOMETRIC VIEW

00	07-06-16	SAT	DWW	EJH	RELEASED TO PRODUCTION		12F193AK-DC	
REV	DATE	BY	CHK	APR	DESCRIPTION		ECN	

TITLE HDQ SERIES FIBER OPTIC FLAT CASSETTES FOR BROCADE FC16-64 PORT BLADE (128 FIBERS) CUSTOMER DRAWING			
ITEM REVISION NAME 12F193AK/00		<b>PANDUIT</b>	
DATASET FILE NAME 12F193AK_DC/00A			
UNLESS OTHERWISE SPECIFIED, DIMENSIONAL TOLERANCES ARE: IN (mm) .x ± .xxx ± .010 (0.3) .xx ± .03 (0.8) ANGLES ±			
DRAWN BY SAT		DATE 06-10-16	CHK DWW
SCALE NONE		DRAWING NUMBER: 12F193AK-DC	
SHT 1 OF 3		SIZE A	

TABLE 1 - HDQ SERIES FIBER OPTIC CASSETTE - MPO TO LC 10 GbE 1RU FLAT PROFILE; 128-FIBER BROCADE LABELING	
PART NUMBER	DESCRIPTION
METHOD A	
F1RBXA-2B08-10S	OM3 ULTRA FIBER; 8-FIBER MPO TO DUPLEX LC
F1RBXO-2B08-10S	OM3 OPTIMIZED FIBER; 8-FIBER MPO TO DUPLEX LC
F1RBZA-2B08-10S	OM4 ULTRA FIBER; 8-FIBER MPO TO DUPLEX LC
F1RBZO-2B08-10S	OM4 OPTIMIZED FIBER; 8-FIBER MPO TO DUPLEX LC

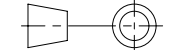
												TITLE	
												HDQ SERIES FIBER OPTIC FLAT CASSETTES FOR BROCADE FC16-64 PORT BLADE (128 FIBERS)	
												CUSTOMER DRAWING	
												ITEM REVISION NAME 12F193AK/00	
												DATASET FILE NAME 12F193AK_DC/00A	
												 MATERIAL: DRAWING NUMBER: 12F193AK-DC	
00	07-06-16	SAT	DWW	EJH	RELEASED TO PRODUCTION						12F193AK-DC	UNLESS OTHERWISE SPECIFIED, DIMENSIONAL TOLERANCES ARE: IN (mm)	
												.x ± .xxx ± .010 (0.3) .xx ± .03 (0.8)      ANGLES ±	
												 THIRD ANGLE PROJECTION	
REV	DATE	BY	CHK	APR	DESCRIPTION		ECN	DRAWN BY SAT	DATE 06-10-16	CHK DWW	SCALE NONE	DRAWING NUMBER: SHT 2 OF 3	SIZE A

THIS COPY IS PROVIDED ON A RESTRICTED BASIS AND IS NOT TO BE USED IN ANY WAY DETRIMENTAL TO THE INTERESTS OF PANDUIT CORP.

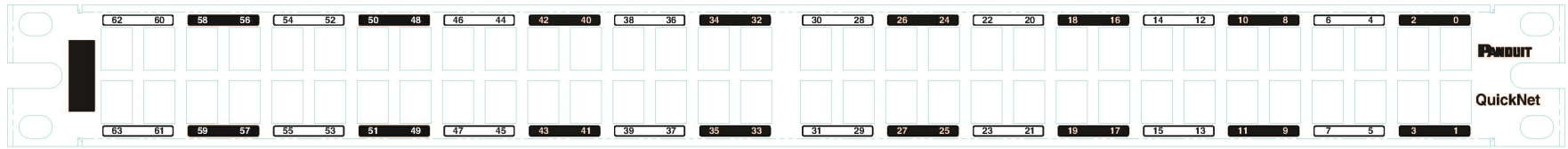

DD-1455A  
Front Panel

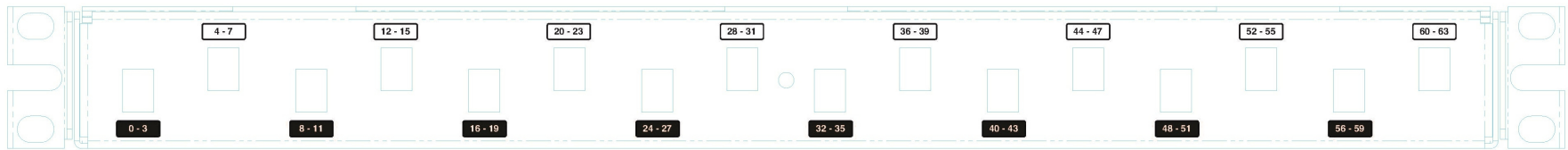

DD-1455B  
Rear Panel

00	07-06-16	SAT	DWW	EJH	RELEASED TO PRODUCTION	12F193AK-DC	
REV	DATE	BY	CHK	APR	DESCRIPTION	ECN	

TITLE				
HDQ SERIES FIBER OPTIC FLAT CASSETTES FOR BROCADE FC16-64 PORT BLADE (128 FIBERS)				
CUSTOMER DRAWING				
ITEM REVISION NAME				<b>PANDUIT</b>
12F193AK/00				
DATASET FILE NAME				MATERIAL:
12F193AK_DC/00A				
UNLESS OTHERWISE SPECIFIED, DIMENSIONAL TOLERANCES ARE: IN (mm)				
.X ±		.xxx ± .010 (0.3)		DRAWING NUMBER:
.xx ± .03 (0.8)		ANGLES ±		
		THIRD ANGLE PROJECTION		12F193AK-DC
DRAWN BY	DATE	CHK	SCALE	SIZE
SAT	06-10-16	DWW	NONE	A

2

1