

TPS6126x, Low-Input Voltage, Boost Converter Evaluation Module

This user's guide describes the TPS6126x evaluation module (EVM) and how to perform a stand-alone evaluation to allow the EVM to interface with the system and host. The TPS61260EVM-673 converter is programmed from the factory to deliver a 3.3-Vdc output voltage for a continuous load of up to 100 mA. The boost converter can be enabled or disabled with the JP1 shunt jumper. Other options with a fixed output voltage are available.

Contents

1	Introduction	2
2	Considerations When Evaluating the TPS6126x	2
3	Performance Specification Summary	2
4	Test Summary	2
4.1	Equipment	3
4.2	Equipment and EVM Setup	3
4.3	Test Procedure – Input: One Alkaline Battery Cell (1.5 V) or Equivalent Power Source	5
5	Schematic, Physical Layouts, and Bill of Materials	7
5.1	Schematic	7
5.2	Physical Layouts	8
5.3	Bill of Materials	11

List of Figures

1	EVM Schematic and Evaluation Setup.....	4
2	Boost Switch Node, V _L and Output Ripple; Vin = 1.5 V, Vout = 3.3 Vdc With 49.9-Ω Load	5
3	Power Down With Enable: Boost Switch Node, V _L , Output, Enable; Vin = 1.5 V, Vout = 3.3 Vdc With 49.9-Ω Load	6
4	Power-Up With Enable: Boost Switch Node, V _L , Output, Enable; Vin = 1.5 V, Vout = 3.3 Vdc With 49.9-Ω Load	6
5	Schematic.....	7
6	Assembly Layer	8
7	Top Layer	9
8	Bottom Layer	10

List of Tables

1	Setup I/O Connections and Configuration for Evaluation of TPS61260EVM	3
2	HPA673A Bill of Materials	11

1 Introduction

The TPS6126x devices provide a power supply solution for products powered by either single- or dual-cell alkaline, NiCd, or NiMH batteries. It also is suitable for products powered by high-output impedance battery types, like coin cells. Output currents can go as high as 100 mA while using a single-cell alkaline battery and discharge it down to 1 V or lower. The boost converter is based on a quasi-fixed-frequency, pulse-width-modulation (PWM) controller using synchronous rectification to obtain maximum efficiency. At low-load currents, the converter enters Power Save mode to ensure high efficiency over a wide-load current range. The maximum average current in the switches is limited to a typical value of 300 mA. The output voltage is programmable using an external resistor divider or is fixed internally on the chip. Additionally, the average output current can be programmed. The converter then regulates the programmed output voltage or the programmed output current, whichever demands lower output power. The converter can be disabled to minimize battery drain. During shutdown, the load is disconnected from the battery. The device is packaged in a 6-pin, SON PowerPAD™ package measuring 2 × 2 mm (DRV).

2 Considerations When Evaluating the TPS6126x

The TPS6126x has a voltage loop, current loop, PFM loop, and burst mode. Operations at these transitions are seamless, but one can see the waveforms adjust between modes, and they may appear erratic. If the input voltage rises up close to the output voltage, the duty cycle decreases until the minimum on-time is reached, and then the switching frequency decreases. Further increase in input voltage starts to push the output voltage higher above regulation, and the part goes into burst mode. For low-input voltage, the duty cycle increases and transitions into burst mode. This increases the ripple voltage. Increasing the load can put the IC in average current mode. This typically means dropping out of voltage regulation and going into current mode, which changes the duty cycle and frequency.

At lower input voltage, < 1 V, the maximum delivered output current is less than 100 mA; see the plot in the TPS61260/1 data sheet ([SLVSA99](#)).

Consider the impedance of the source; for higher impedances and larger loads, consider putting more input capacitance. The waveforms can look different depending on whether the load is resistive or a constant-current load.

3 Performance Specification Summary

Specification	Test Conditions	MIN	TYP	MAX	UNIT
Input dc voltage, DC	Recommended V_{in} range	0.8		4	V
Output load current, DC	Maximum load current			50	mA

4 Test Summary

The TPS61260EVM-673 board requires an adjustable laboratory power supply set between 0.8 Vdc and 4 Vdc with an input current limit set to ~450 mA and a load of 100 mA or less (>33 Ω). The test setup connections and jumper-setting selections are configured for a stand-alone evaluation, but can be changed to interface with external hardware such as a system load and microcontroller. As the input voltage drops below 1 V, the 100-mA maximum output current may roll off due to power limitations.

4.1 Equipment

- Adjustable dc power supply between 0.8 V and 4 V with adjustable current limit set to ~450 mA
- Load: system load or resistive load $\geq 33 \Omega$
- Three Fluke 75 digital multimeters (DMM) (equivalent or better)
- Oscilloscope, model TDS222 (equivalent or better)

4.2 Equipment and EVM Setup

Table 1. Setup I/O Connections and Configuration for Evaluation of TPS61260EVM

Jack/Component (Silk Screen)	Connect or Adjust to:
J1-1/2 (Vin)	Power supply positive lead, preset to 1.5-Vdc, 350-mA current limit
J3-1/2 (GND)	Power supply negative lead (1.5-Vdc supply)
J2-1 (+ SNS); input	Positive lead of DMM #1
J2-2 (- SNS); input	Negative lead of DMM #1
J4-1/2 (Vout)	Positive lead to system load or load resistance
J6-1/2 (GND)	Negative lead to system load or load resistance
J5-1 (+ SNS); output	Positive lead of DMM #2
J5-2 (- SNS); output	Negative lead of DMM #2
JP1-1/2 Vin/EN (On)	Apply shunt to ON for converter operation
JP1-2/3 EN/GND (Off)	See procedure

Connect the meters, scope probes, output load, shunt, and input power supply as listed in [Table 1](#) or shown in [Figure 1](#). Set scope to 200 ns/div, positive trigger, dc-coupled on CH1, 1 V/div; CH2: ac-coupled and 10 mV/div. Additional channels can be added or probes can be moved to view Vin and Ven. The resistive load can be replaced with a system load or decade load box to vary the load between 1 k Ω and 33 Ω .

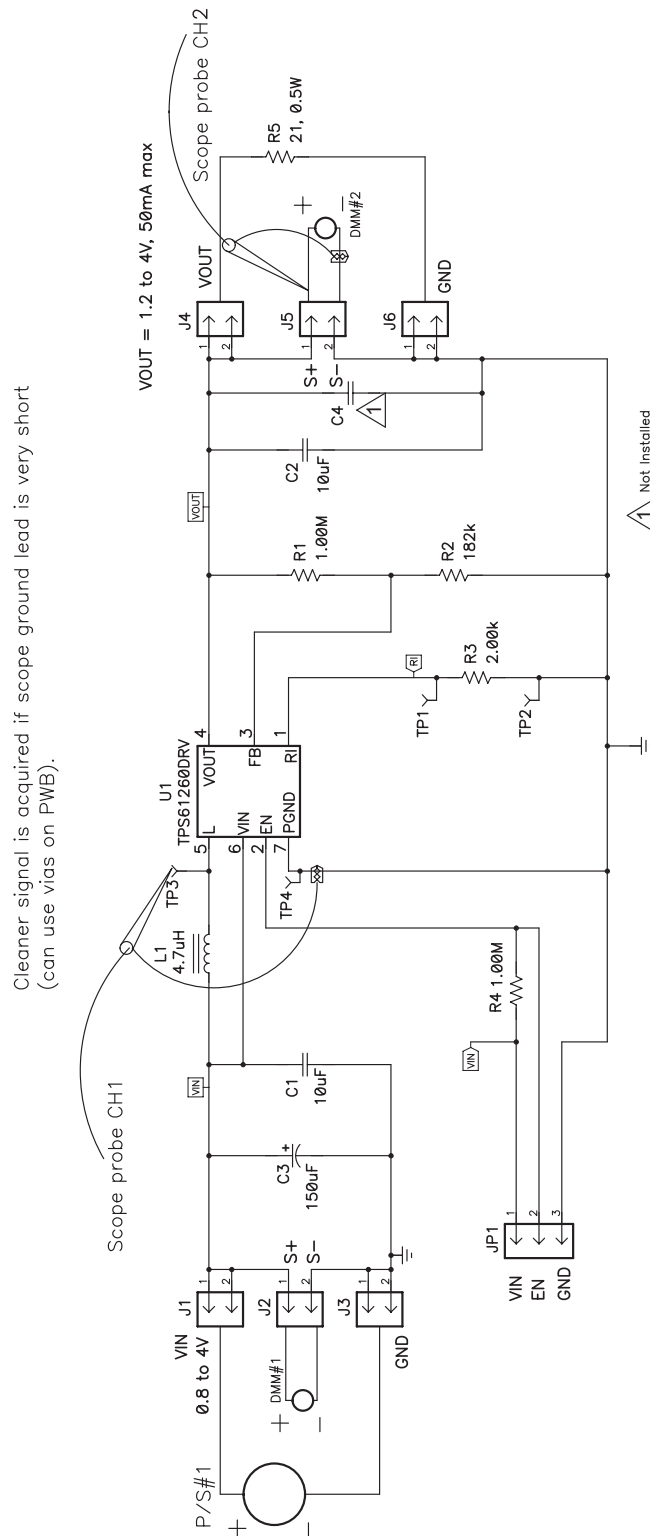

Figure 1. EVM Schematic and Evaluation Setup

4.3 Test Procedure – Input: One Alkaline Battery Cell (1.5 V) or Equivalent Power Source

1. Make sure that the EVM is set up according to [Table 1](#) and [Figure 1](#), and that the power supply is preset to 1.5 Vdc at ~350 mA current limit.
2. Turn on the input supply, and verify the input voltage is ~1.5 Vdc (DMM#1), and the output voltage is between 3.15 Vdc and 3.4 Vdc (DMM#2).
3. Look at CH1 and CH2, and verify that the duty cycle is between 54% and 60%, and the ripple is less than 10 mV. Note that the duty cycle is the on-time (low) divided by the period ([Figure 2](#)).
4. Move shunt on JP1-ON to JP1-OFF, and verify that the boost converter is disabled (see [Figure 3](#)).
5. Remove the shunt on JP1-OFF and place on JP1-ON. Verify that the converter starts back up (see [Figure 4](#)).
6. Vary input voltage and load to understand performance of EVM. The EVM's output cuts off when the input drops to ~0.8 V, and the circuit goes into a PFM mode when the input approaches 3.3 V.

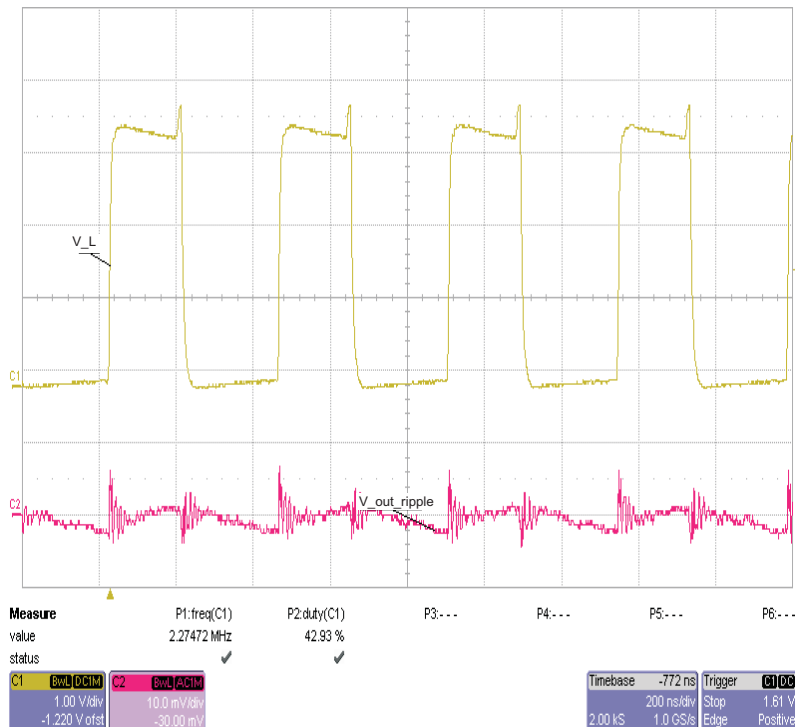

Figure 2. Boost Switch Node, V_L and Output Ripple; Vin = 1.5 V, Vout = 3.3 Vdc With 49.9-Ω Load

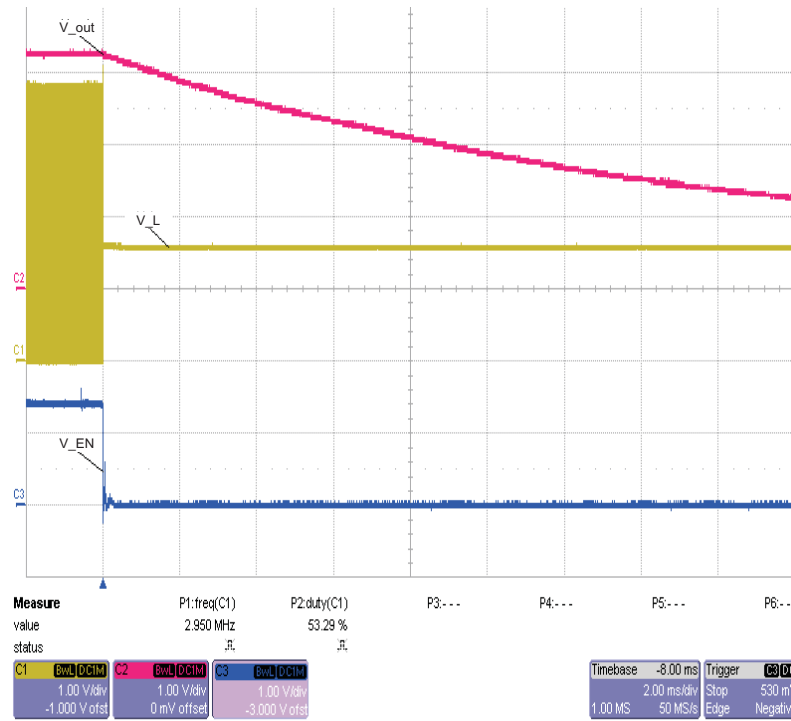

Figure 3. Power Down With Enable: Boost Switch Node, V_L, Output, Enable; Vin = 1.5 V, Vout = 3.3 Vdc With 49.9-Ω Load

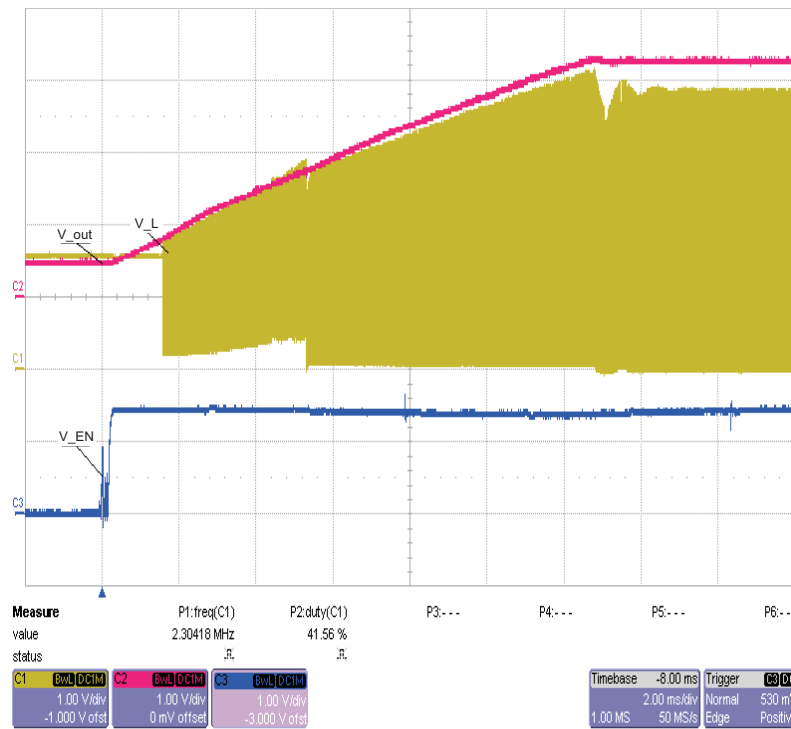

Figure 4. Power-Up With Enable: Boost Switch Node, V_L, Output, Enable; Vin = 1.5 V, Vout = 3.3 Vdc With 49.9-Ω Load

5 Schematic, Physical Layouts, and Bill of Materials

5.1 Schematic

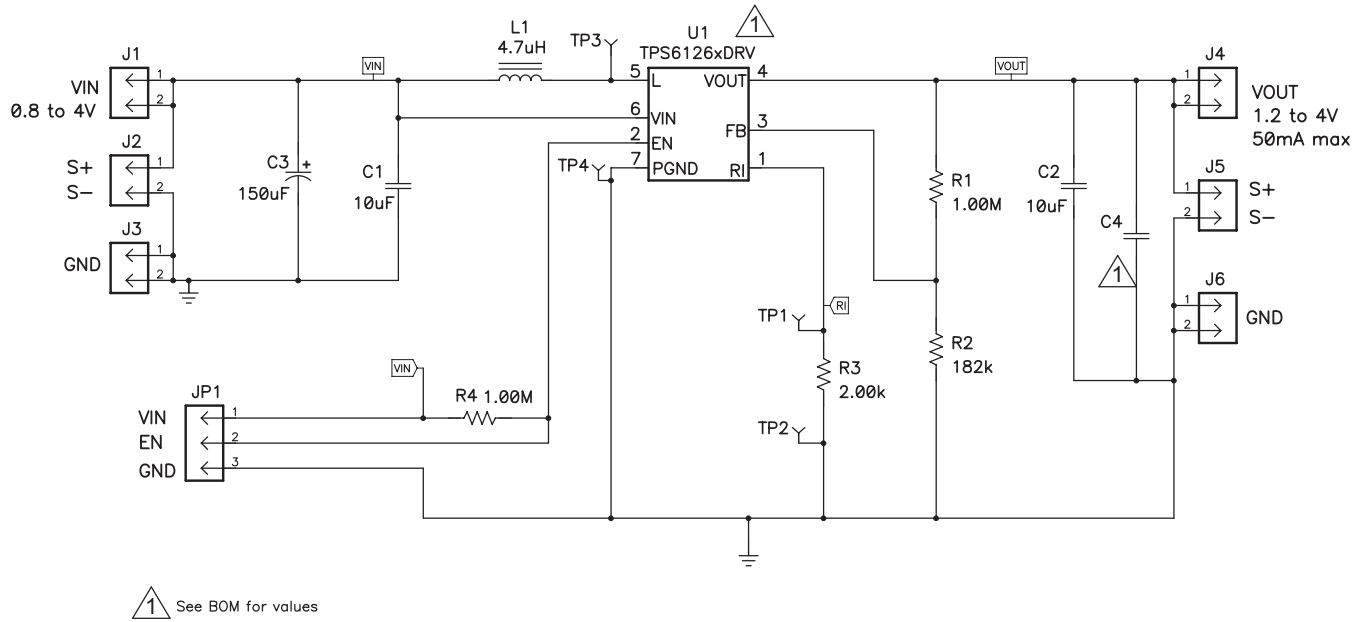

Figure 5. Schematic

5.2 Physical Layouts

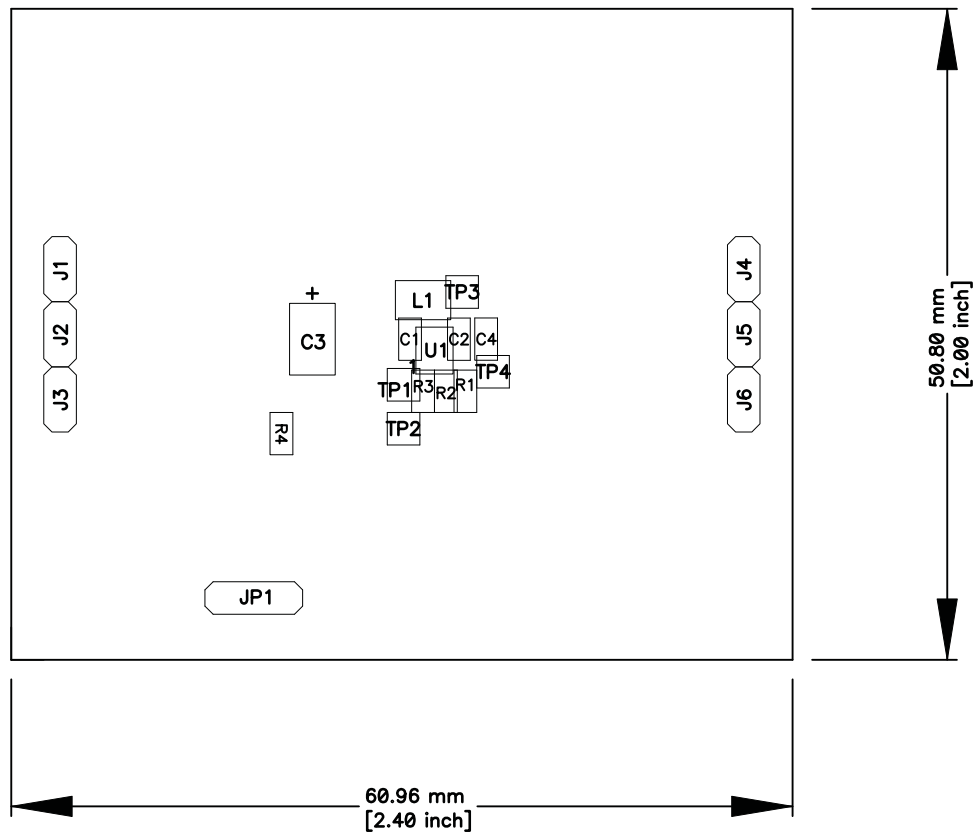

Figure 6. Assembly Layer

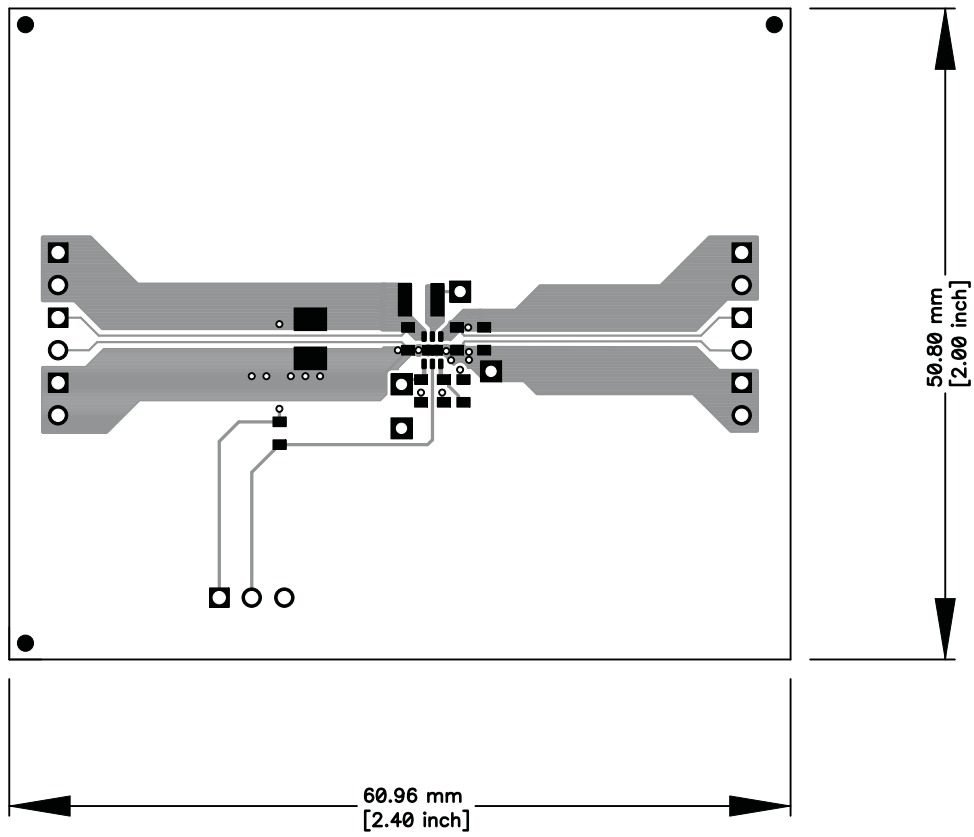

Figure 7. Top Layer

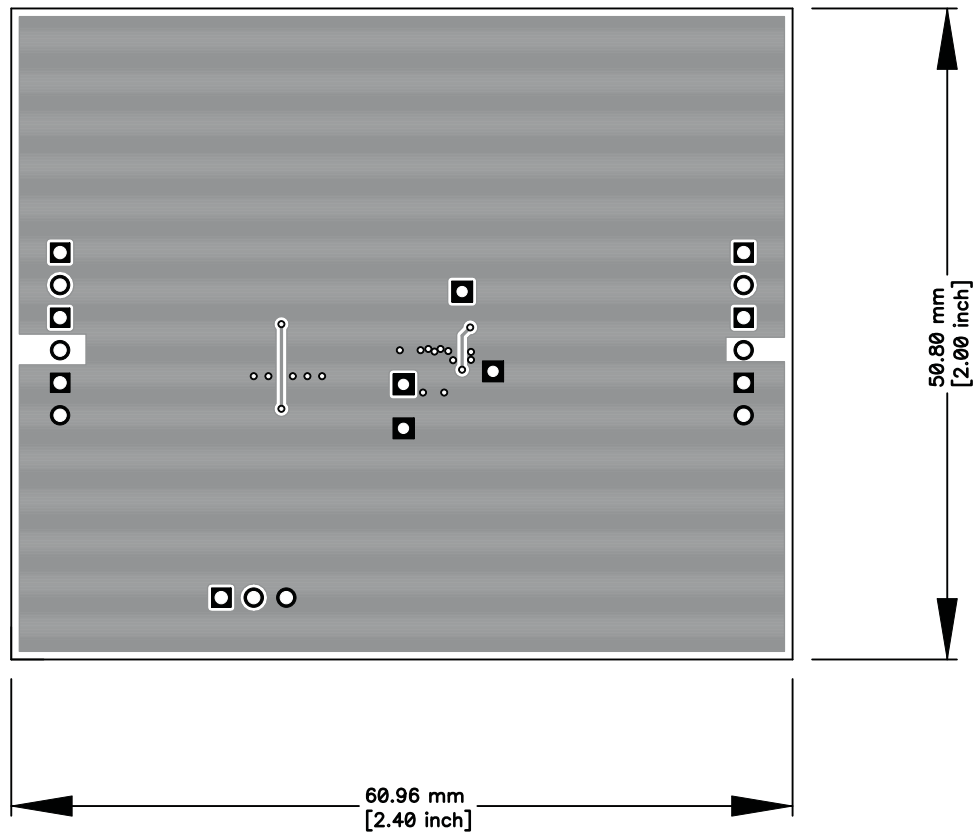

Figure 8. Bottom Layer

5.3 Bill of Materials

Table 2. HPA673A Bill of Materials

-001						
Count	RefDes	Value	Description	Size	Part Number	MFR
2	C1, C2	10uF	Capacitor, Ceramic, Low Inductance, 6.3V, X5R, 20%	0603	GRM188R60J106ME47D	Murata
1	C3	150uF	Capacitor, Tantalum, 6.3V, 25milliohm, 20%	3528(B)	T520B157M006ATE025	Kemet
0	C4		Capacitor, Ceramic, Low Inductance, 6.3V, X5R, 20%	0603		Murata
6	J1, J2, J3, J4, J5, J6	PEC02SAAN	Header, Male 2-pin, 100mil spacing	0.100 inch x 2	PEC02SAAN	Sullins
1	JP1	PEC03SAAN	Header, Male 3-pin, 100mil spacing,	0.100 inch x 3	PEC03SAAN	Sullins
1	L1	4.7uH	Inductor, Power, 1.1 A, 138 milliohms	2.5 x 2.0 mm	LQM2HPN4R7MG0	Murata
2	R1, R4	1.00M	Resistor, Chip, 1/16W, 1%	0603	Std	Std
1	R2	182k	Resistor, Chip, 1/16W, 1%	0603	Std	Std
1	R3	2.00k	Resistor, Chip, 1/16W, 1%	0603	Std	Std
1	U1	TPS61260DRV	IC, Tiny Low Input Voltage Boost Converter	SON	TPS61260DRV	TI
1	--		PCB, 2.4 In x 2 In x 0.031 In		HPA673	Any
1			Label - See note 5	1.25 x 0.25 inch	THT-13-457-10	Brady
1	Apply on: JP1-ON		Shunt, 100-mil, Black	0.1	929950-00	3M

Evaluation Board/Kit Important Notice

Texas Instruments (TI) provides the enclosed product(s) under the following conditions:

This evaluation board/kit is intended for use for **ENGINEERING DEVELOPMENT, DEMONSTRATION, OR EVALUATION PURPOSES ONLY** and is not considered by TI to be a finished end-product fit for general consumer use. Persons handling the product(s) must have electronics training and observe good engineering practice standards. As such, the goods being provided are not intended to be complete in terms of required design-, marketing-, and/or manufacturing-related protective considerations, including product safety and environmental measures typically found in end products that incorporate such semiconductor components or circuit boards. This evaluation board/kit does not fall within the scope of the European Union directives regarding electromagnetic compatibility, restricted substances (RoHS), recycling (WEEE), FCC, CE or UL, and therefore may not meet the technical requirements of these directives or other related directives.

Should this evaluation board/kit not meet the specifications indicated in the User's Guide, the board/kit may be returned within 30 days from the date of delivery for a full refund. **THE FOREGOING WARRANTY IS THE EXCLUSIVE WARRANTY MADE BY SELLER TO BUYER AND IS IN LIEU OF ALL OTHER WARRANTIES, EXPRESSED, IMPLIED, OR STATUTORY, INCLUDING ANY WARRANTY OF MERCHANTABILITY OR FITNESS FOR ANY PARTICULAR PURPOSE.**

The user assumes all responsibility and liability for proper and safe handling of the goods. Further, the user indemnifies TI from all claims arising from the handling or use of the goods. Due to the open construction of the product, it is the user's responsibility to take any and all appropriate precautions with regard to electrostatic discharge.

EXCEPT TO THE EXTENT OF THE INDEMNITY SET FORTH ABOVE, NEITHER PARTY SHALL BE LIABLE TO THE OTHER FOR ANY INDIRECT, SPECIAL, INCIDENTAL, OR CONSEQUENTIAL DAMAGES.

TI currently deals with a variety of customers for products, and therefore our arrangement with the user **is not exclusive.**

TI assumes **no liability for applications assistance, customer product design, software performance, or infringement of patents or services described herein.**

Please read the User's Guide and, specifically, the Warnings and Restrictions notice in the User's Guide prior to handling the product. This notice contains important safety information about temperatures and voltages. For additional information on TI's environmental and/or safety programs, please contact the TI application engineer or visit www.ti.com/esh.

No license is granted under any patent right or other intellectual property right of TI covering or relating to any machine, process, or combination in which such TI products or services might be or are used.

FCC Warning

This evaluation board/kit is intended for use for **ENGINEERING DEVELOPMENT, DEMONSTRATION, OR EVALUATION PURPOSES ONLY** and is not considered by TI to be a finished end-product fit for general consumer use. It generates, uses, and can radiate radio frequency energy and has not been tested for compliance with the limits of computing devices pursuant to part 15 of FCC rules, which are designed to provide reasonable protection against radio frequency interference. Operation of this equipment in other environments may cause interference with radio communications, in which case the user at his own expense will be required to take whatever measures may be required to correct this interference.

EVM Warnings and Restrictions

It is important to operate this EVM within the input voltage range of 0.8 V to 4 V and the output voltage range of 1.8 V to 4 V .

Exceeding the specified input range may cause unexpected operation and/or irreversible damage to the EVM. If there are questions concerning the input range, please contact a TI field representative prior to connecting the input power.

Applying loads outside of the specified output range may result in unintended operation and/or possible permanent damage to the EVM. Please consult the EVM User's Guide prior to connecting any load to the EVM output. If there is uncertainty as to the load specification, please contact a TI field representative.

During normal operation, some circuit components may have case temperatures greater than 50°C. The EVM is designed to operate properly with certain components above 50°C as long as the input and output ranges are maintained. These components include but are not limited to linear regulators, switching transistors, pass transistors, and current sense resistors. These types of devices can be identified using the EVM schematic located in the EVM User's Guide. When placing measurement probes near these devices during operation, please be aware that these devices may be very warm to the touch.

Mailing Address: Texas Instruments, Post Office Box 655303, Dallas, Texas 75265
Copyright © 2011, Texas Instruments Incorporated

IMPORTANT NOTICE

Texas Instruments Incorporated and its subsidiaries (TI) reserve the right to make corrections, modifications, enhancements, improvements, and other changes to its products and services at any time and to discontinue any product or service without notice. Customers should obtain the latest relevant information before placing orders and should verify that such information is current and complete. All products are sold subject to TI's terms and conditions of sale supplied at the time of order acknowledgment.

TI warrants performance of its hardware products to the specifications applicable at the time of sale in accordance with TI's standard warranty. Testing and other quality control techniques are used to the extent TI deems necessary to support this warranty. Except where mandated by government requirements, testing of all parameters of each product is not necessarily performed.

TI assumes no liability for applications assistance or customer product design. Customers are responsible for their products and applications using TI components. To minimize the risks associated with customer products and applications, customers should provide adequate design and operating safeguards.

TI does not warrant or represent that any license, either express or implied, is granted under any TI patent right, copyright, mask work right, or other TI intellectual property right relating to any combination, machine, or process in which TI products or services are used. Information published by TI regarding third-party products or services does not constitute a license from TI to use such products or services or a warranty or endorsement thereof. Use of such information may require a license from a third party under the patents or other intellectual property of the third party, or a license from TI under the patents or other intellectual property of TI.

Reproduction of TI information in TI data books or data sheets is permissible only if reproduction is without alteration and is accompanied by all associated warranties, conditions, limitations, and notices. Reproduction of this information with alteration is an unfair and deceptive business practice. TI is not responsible or liable for such altered documentation. Information of third parties may be subject to additional restrictions.

Resale of TI products or services with statements different from or beyond the parameters stated by TI for that product or service voids all express and any implied warranties for the associated TI product or service and is an unfair and deceptive business practice. TI is not responsible or liable for any such statements.

TI products are not authorized for use in safety-critical applications (such as life support) where a failure of the TI product would reasonably be expected to cause severe personal injury or death, unless officers of the parties have executed an agreement specifically governing such use. Buyers represent that they have all necessary expertise in the safety and regulatory ramifications of their applications, and acknowledge and agree that they are solely responsible for all legal, regulatory and safety-related requirements concerning their products and any use of TI products in such safety-critical applications, notwithstanding any applications-related information or support that may be provided by TI. Further, Buyers must fully indemnify TI and its representatives against any damages arising out of the use of TI products in such safety-critical applications.

TI products are neither designed nor intended for use in military/aerospace applications or environments unless the TI products are specifically designated by TI as military-grade or "enhanced plastic." Only products designated by TI as military-grade meet military specifications. Buyers acknowledge and agree that any such use of TI products which TI has not designated as military-grade is solely at the Buyer's risk, and that they are solely responsible for compliance with all legal and regulatory requirements in connection with such use.

TI products are neither designed nor intended for use in automotive applications or environments unless the specific TI products are designated by TI as compliant with ISO/TS 16949 requirements. Buyers acknowledge and agree that, if they use any non-designated products in automotive applications, TI will not be responsible for any failure to meet such requirements.

Following are URLs where you can obtain information on other Texas Instruments products and application solutions:

Products

Audio	www.ti.com/audio
Amplifiers	amplifier.ti.com
Data Converters	dataconverter.ti.com
DLP® Products	www.dlp.com
DSP	dsp.ti.com
Clocks and Timers	www.ti.com/clocks
Interface	interface.ti.com
Logic	logic.ti.com
Power Mgmt	power.ti.com
Microcontrollers	microcontroller.ti.com
RFID	www.ti-rfid.com
RF/IF and ZigBee® Solutions	www.ti.com/lprf

Applications

Communications and Telecom	www.ti.com/communications
Computers and Peripherals	www.ti.com/computers
Consumer Electronics	www.ti.com/consumer-apps
Energy and Lighting	www.ti.com/energy
Industrial	www.ti.com/industrial
Medical	www.ti.com/medical
Security	www.ti.com/security
Space, Avionics and Defense	www.ti.com/space-avionics-defense
Transportation and Automotive	www.ti.com/automotive
Video and Imaging	www.ti.com/video
Wireless	www.ti.com/wireless-apps

TI E2E Community Home Page

e2e.ti.com

Mailing Address: Texas Instruments, Post Office Box 655303, Dallas, Texas 75265
Copyright © 2011, Texas Instruments Incorporated