

NOTES:

1. Material : Stainless Steel
2. Total Coils : 8.000
3. Solid Height : 0.450 (in)
4. Finish : ZINC
5. Ends : Closed
6. All Drawing Dimensions are in Inches [mm]

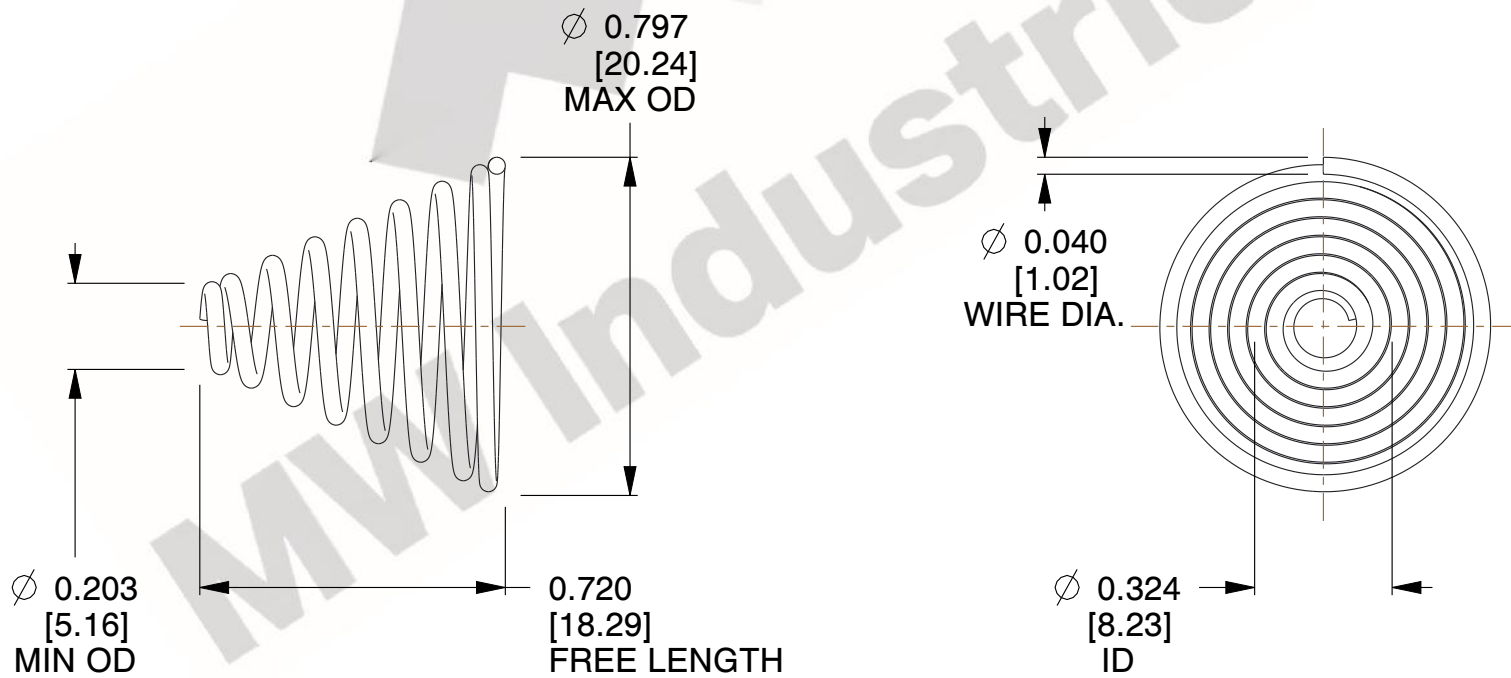
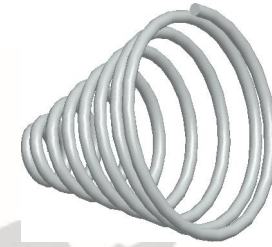

COMPONENT TAPERED SPRINGS