

# SMA 50 Ohm Right Angle Bulkhead Jack Receptacle

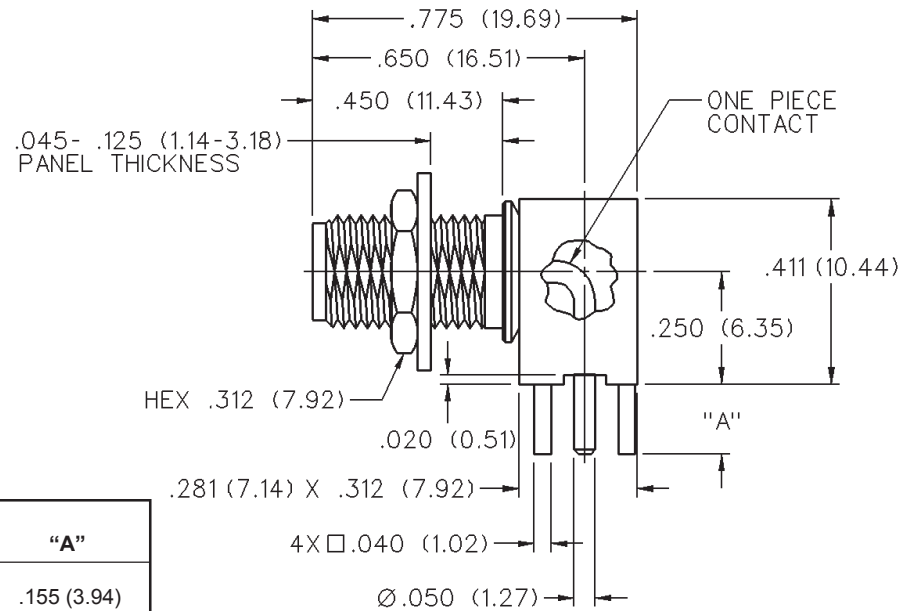

INCHES (MILLIMETERS)  
CUSTOMER DRAWINGS AVAILABLE UPON REQUEST

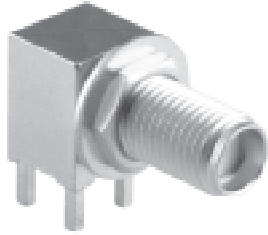

VSWR & FREQ. RANGE	GOLD PLATED	NICKEL PLATED	"A"
VSWR: N/A 0-18 GHz	142-0701-501	142-0701-506	.155 (3.94)

Mounting hole layouts

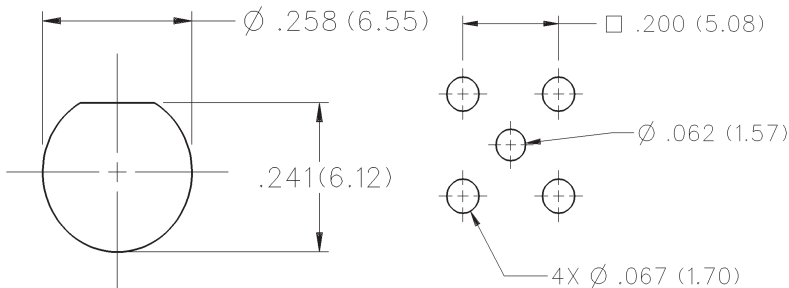

# SMA - 50 Ohm Connectors

## Specifications



INCHES (MILLIMETERS)  
CUSTOMER DRAWINGS AVAILABLE UPON REQUEST

## ELECTRICAL RATINGS

**Impedance:** 50 ohms

**Frequency Range:**

Dummy loads .....	0-2 GHz
Flexible cable connectors .....	0-12.4 GHz
Uncabled receptacles, RA semi-rigid and adapters .....	0-18.0 GHz
Straight semi-rigid cable connectors and field replaceable connectors .....	0-26.5 GHz

**VSWR:** (f = GHz)

	Straight Cabled Connectors	Right Angle Cabled Connectors
RG-178 cable .....	1.20 + .025f	1.20 + .03f
RG-316, LMR-100 cable .....	1.15 + .02f	1.15 + .03f
RG-58, LMR-195 cable .....	1.15 + .01f	1.15 + .02f
RG-142 cable .....	1.15 + .01f	1.15 + .02f
LMR-200, LMR-240 cable .....	1.10 + .03f	1.10 + .06f
.086 semi-rigid .....	1.07 + .008f	1.18 + .015f
.141 semi-rigid (w/contact) .....	1.05 + .008f	1.15 + .015f
.141 semi-rigid (w/o contact) .....	1.035 + .005f	

Jack-bulkhead jack adapter and plug-plug adapter .....

Jack-jack adapter and plug-jack adapter .....

Uncabled receptacles, dummy loads .....

Field replaceable (see page 59) .....

**Working Voltage:** (Vrms maximum)

Connectors for Cable Type	Sea Level	70K Feet
RG-178 .....	170	45
RG-316; LMR-100, 195, 200 .....	250	65
RG-58, RG-142, LMR-240, .086 semi-rigid, uncabled receptacles, .141 semi-rigid w/o contact ...	335	85
.141 semi-rigid with contact and adapters .....	500	125
Dummy loads .....	N/A	

**Dielectric Withstanding Voltage:** (VRMS minimum at sea level)

Connectors for RG-178 .....	500
Connectors for RG-316; LMR-100, 195, 200 .....	750
Connectors for RG-58, RG-142, LMR-240, .086 semi-rigid, field replaceable, uncabled receptacles .....	1000
Connectors for .141 semi-rigid with contact and adapters .....	1500
Connectors for .141 semi-rigid w/o contact, dummy loads .....	N/A

**Corona Level:** (Volts minimum at 70,000 feet)

Connectors for RG-178 .....	125
Connectors for RG-316; LMR-100, 195, 200 .....	190
Connectors for RG-58, RG-142, LMR-240, .086 semi-rigid, uncabled receptacles, .141 semi-rigid w/o contact .....	250
Connectors for .141 semi-rigid with contact and adapters .....	375
Dummy loads .....	N/A

**Insertion Loss:** (dB maximum)

Straight flexible cable connectors and adapters .....	0.06	$\sqrt{f}$ (GHz), tested at 6 GHz
Right angle flexible cable connectors .....	0.15	$\sqrt{f}$ (GHz), tested at 6 GHz
Straight semi-rigid cable connectors with contact .....	0.03	$\sqrt{f}$ (GHz), tested at 10 GHz
Right angle semi-rigid cable connectors .....	0.05	$\sqrt{f}$ (GHz), tested at 10 GHz
Straight semi-rigid cable connectors w/o contact .....	0.03	$\sqrt{f}$ (GHz), tested at 16 GHz
Straight low loss flexible cable connectors .....	0.06	$\sqrt{f}$ (GHz), tested at 1 GHz
Right Angle low loss flexible cable connectors .....	0.15	$\sqrt{f}$ (GHz), tested at 1 GHz
Uncabled receptacles, field replaceable, dummy loads .....		N/A

**Insulation Resistance:** 5000 megohms minimum

**Contact Resistance:** (milliohms maximum) **Initial** **After Environmental**

Center contact (straight cabled connectors and uncabled receptacles) .....	3.0*	4.0*
Center contact (right angle cabled connectors and adapters) .....	4.0	6.0
Field replaceable connectors .....	6.0	8.0
Outer contact (all connectors) .....	2.0	N/A
Braid to body (gold plated connectors) .....	0.5	N/A
Braid to body (nickel plated connectors) .....	5.0	N/A

\*N/A where the cable center conductor is used as a contact

**RF Leakage:** (dB minimum, tested at 2.5 GHz)

Flexible cable connectors, adapters and .141 semi-rigid connectors w/o contact .....	-60 dB
Field replaceable w/o EMI gasket .....	-70 dB
.086 semi-rigid connectors and .141 semi-rigid connectors with contact, and field replaceable with EMI Gasket .....	-90 dB
Two-way adapters .....	-90 dB
Uncabled receptacles, dummy loads .....	N/A

**RF High Potential Withstanding Voltage:** (Vrms minimum, tested at 4 and 7 MHz)

Connectors for RG-178 .....	335
Connectors for RG-316; LMR-100, 195, 200 .....	500
Connectors for RG-58, RG-142, LMR-240, .086 semi-rigid, .141 semi-rigid cable w/o contact, uncabled receptacles .....	670
Connectors for .141 semi-rigid with contact and adapters .....	1000

**Power Rating (Dummy Load):** 0.5 watt @ +25°C, derated to 0.25 watt @ +125°C

## MECHANICAL RATINGS

**Engagement Design:** MIL-C-39012, Series SMA

**Engagement/Disengagement Force:** 2 inch-pounds maximum

**Mating Torque:** 7 to 10 inch-pounds

**Bulkhead Mounting Nut Torque:** 15 inch-pounds

**Coupling Proof Torque:** 15 inch-pounds minimum

**Coupling Nut Retention:** 60 pounds minimum

**Contact Retention:**

6 lbs. minimum axial force (captivated contacts)

4 inch-ounce minimum torque (uncabled receptacles)

**Cable Retention:**

	Axial Force*(lbs)	Torque (in-oz)
Connectors for RG-178 .....	10	N/A
Connectors for RG-316, LMR-100 .....	20	N/A
Connectors for LMR-195, 200 .....	30	N/A
Connectors for RG-58, LMR-240 .....	40	N/A
Connectors for RG-142 .....	45	N/A
Connectors for .086 semi-rigid .....	30	16
Connectors for .141 semi-rigid .....	60	55

\*Or cable breaking strength whichever is less.

**Durability:** 500 cycles minimum

100 cycles minimum for .141 semi-rigid connectors w/o contact

**ENVIRONMENTAL RATINGS** (Meets or exceed the applicable paragraph of MIL-C-39012)

**Temperature Range:** - 65°C to + 165°C

**Thermal Shock:** MIL-STD-202, Method 107, Condition B

**Corrosion:** MIL-STD-202, Method 101, Condition B

**Shock:** MIL-STD-202, Method 213, Condition I

**Vibration:** MIL-STD-202, Method 204, Condition D

**Moisture Resistance:** MIL-STD-202, Method 106

†Avoid user injury due to misapplication. See safety advisory definitions inside front cover.

# SMA - 50 Ohm Connectors

Specifications



INCHES (MILLIMETERS)  
CUSTOMER DRAWINGS AVAILABLE UPON REQUEST

## MATERIAL SPECIFICATIONS

**Bodies:** Brass per QQ-B-626, gold plated\* per MIL-G-45204 .00001" min. or nickel plated per QQ-N-290

**Contacts:** Male - brass per QQ-B-626, gold plated per MIL-G-45204 .00003" min.

Female - beryllium copper per QQ-C-530, gold plated per MIL-G-45204 .00003" min.

**Nut Retention Spring:** Beryllium copper per QQ-C-533. Unplated

**Insulators:** PTFE fluorocarbon per ASTM D 1710 and ASTM D 1457 or Tefzel per ASTM D 3159 or PFA 340 per ASTM

**Expansion Caps:** Brass per QQ-B-613, gold plated per MIL-G-45204 .00001" min. or nickel plated per QQ-N-290

**Crimp Sleeves:** Copper per WW-T-799 or brass per QQ-B-613, gold plated per MIL-G-45204 .00001" min. or nickel plated per QQ-N-290

**Mounting Hardware:** Brass per QQ-B-626 or QQ-B-613, gold plated per MIL-G-45204 .00001" min. or nickel plated per QQ-N-290

**Seal Rings:** Silicone rubber per ZZ-R-765

**EMI Gaskets:** Conductive silicone rubber per MIL-G-83528, Type M

\* All gold plated parts include a .00005" min. nickel underplate barrier layer.

### Mating Engagement for SMA Series per MIL-C-39012

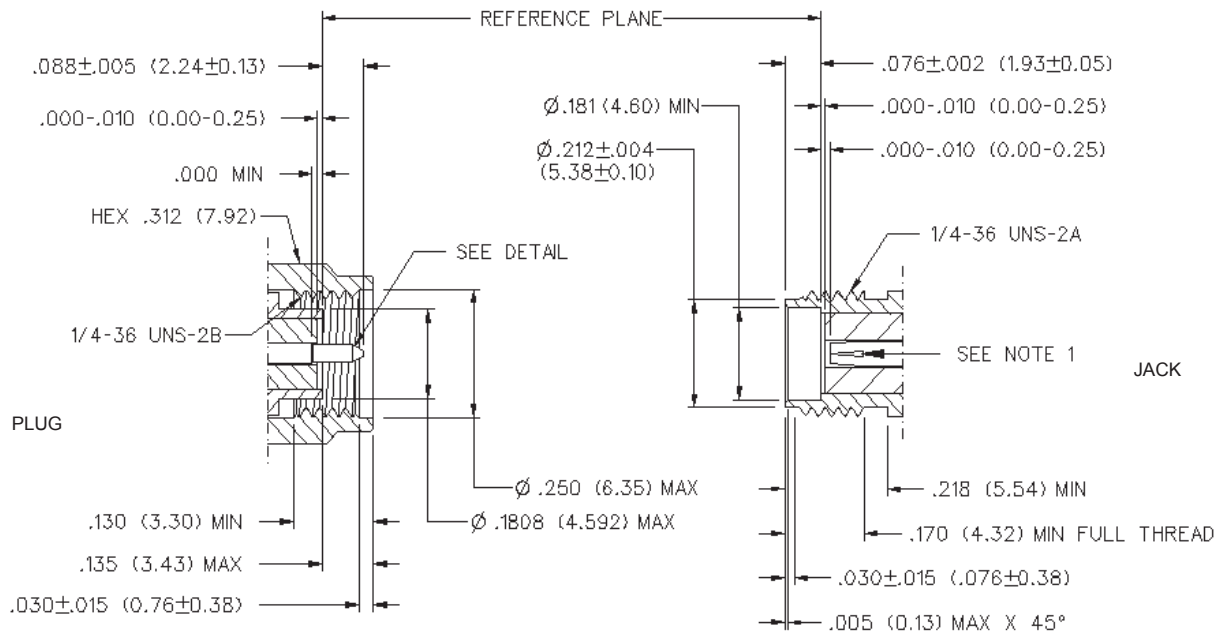

#### NOTES

1. ID OF CONTACT TO MEET VSWR, CONTACT RESISTANCE AND INSERTION WITHDRAWAL FORCES WHEN MATED WITH DIA. .0355-.0370 MALE PIN.

**Cinch Connectivity Solutions**

299 Johnson Avenue SW, Waseca, MN 56093 USA • 800.247.8256 • +1 507 833 8822 • cinchconnectivity.com