



Industrial Computer Products Data Acquisition System

RMV-511

Intelligent Multiport Serial to GPRS Gateway with I/O

User manual V1.0

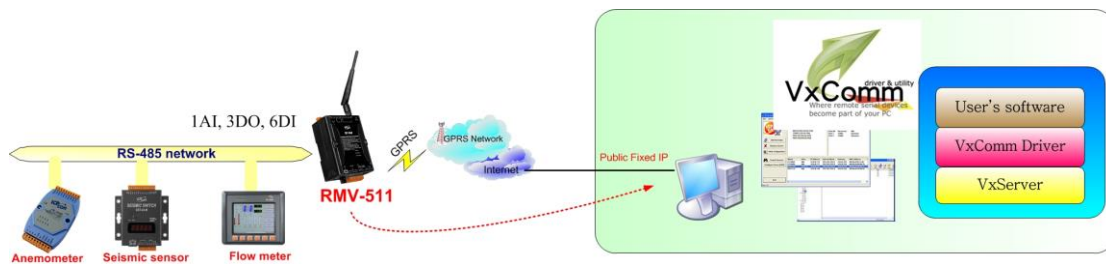

Warranty

All products manufactured by ICP DAS are under warranty regarding defective materials for a period of one year, beginning from the date of delivery to the original purchaser.

Warning

ICP DAS assumes no liability for damages consequent to the use of this product. ICP DAS reserves the right to change this manual at any time without notice. The information furnished by ICP DAS is believed to be accurate and reliable. However, no responsibility is assumed by ICP DAS for its use, or for any infringements of patents or other rights of third parties resulting from its use.

Copyright

Copyright © 2013 by ICP DAS CO., LTD. All rights are reserved.

Trademark

The names used for identification only may be registered trademarks of their respective companies.

Version Record

Version	By	Date	Description
1.00	Kane	2012/06/24	Release Version

Table of Contents

1.	Introduction.....	4
1.1	Features.....	4
1.2	Applications.....	5
2.	Hardware.....	6
2.1	Specifications.....	6
2.2	Appearance and Pin Assignments.....	8
2.3	Dimensions.....	9
2.4	DI/DO internal Structure and Wire Connection.....	10
2.5	LED Indicators.....	11
2.6	Installing RMV-511.....	12
3.	Installing the RMV-511 Utility.....	13
3.1	Installing .NET Framework.....	13
3.2	Installing the RMV-511 Utility.....	16
4.	The RMV-511 Utility operation description.....	19
4.1	Main Menu.....	19
4.2	File Menu.....	21
4.3	Connecting to the RMV-511.....	21
4.4	Parameters.....	22
4.5	Download/Upload Parameters.....	23
4.6	I/O Monitor.....	24
4.7	System.....	25
4.7.1	Signal Quality.....	25
4.7.2	Reboot the RMV-511.....	25
4.7.3	Inputting the PIN/PUK.....	26
4.7.4	Recover to the Factory Settings.....	27
4.7.5	Inquiring System status.....	27
4.7.6	Inquiring Firmware Version.....	28
5.	How to use the RMV-511 Utility through the Virtual com to access remote the parameters of the RMV-511.....	29
5.1	The necessary software installed.....	29
5.2	Setting the VxServer and VxComm Driver.....	30
6.	Modbus RTU Protocol.....	35
6.1	Commands and Description.....	35
6.2	Modbus address table.....	37

1. Introduction

The RMV-511 is an intelligent multiport serial to GPRS gateway with I/O for industry M2M applications. It is designed for linking RS-485 devices to a GPRS network and remote I/O monitor. The user-friendly Axiom Driver/Utility and VxServer allow users to easily turn the built-in COM ports of the RMV-511 into standard COM ports on a PC. By virtue of its protocol independence, a small-core OS and high flexibility, the RMV-511 is able to meet the demands of every network-enabled application. In addition, the RMV-511 also supports GPRS network automatic re-connection function when the RMV-511 is broke the GPRS network by something happened. It also supports remote I/O monitor via virtual COM by Modbus RTU protocol. M2M solution will improve the service quality and reduce operating costs. Many application areas can be improved by using RMV-511.

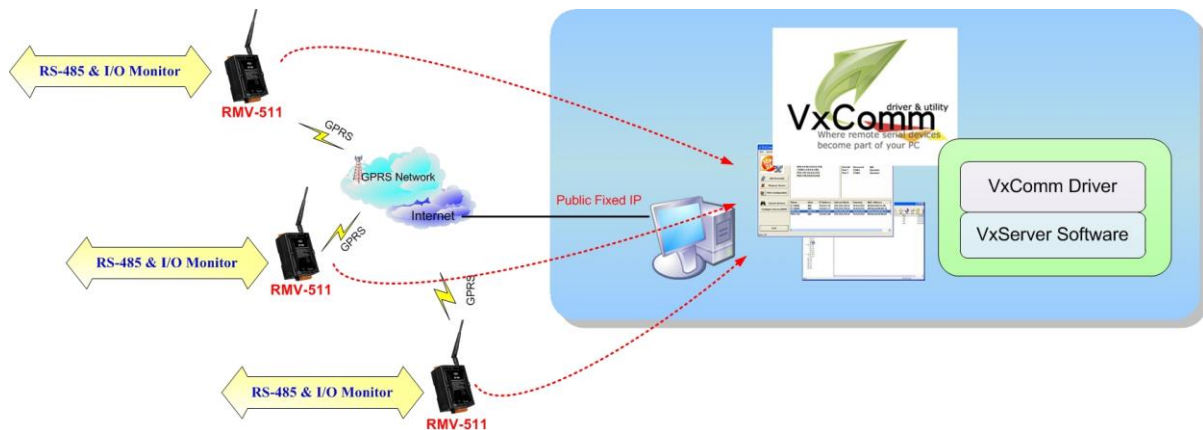

1.1 Features

- Support GSM/GPRS 850/900/1800/1900 MHz
- Virtual COM Extend Real COM Ports via GPRS
- Support GPRS network automatic re-connection function
- Remote I/O Control via utility COM by Modbus RTU Protocol
- 1*Utility Port for Configuration
- 1*RS485, 6*DI, 2*DO, 1*AI
- Power Reverse Polarity Protection
- Power supply +10 VDC ~ +30 VDC

1.2 Applications

➤ PLC remote maintenance

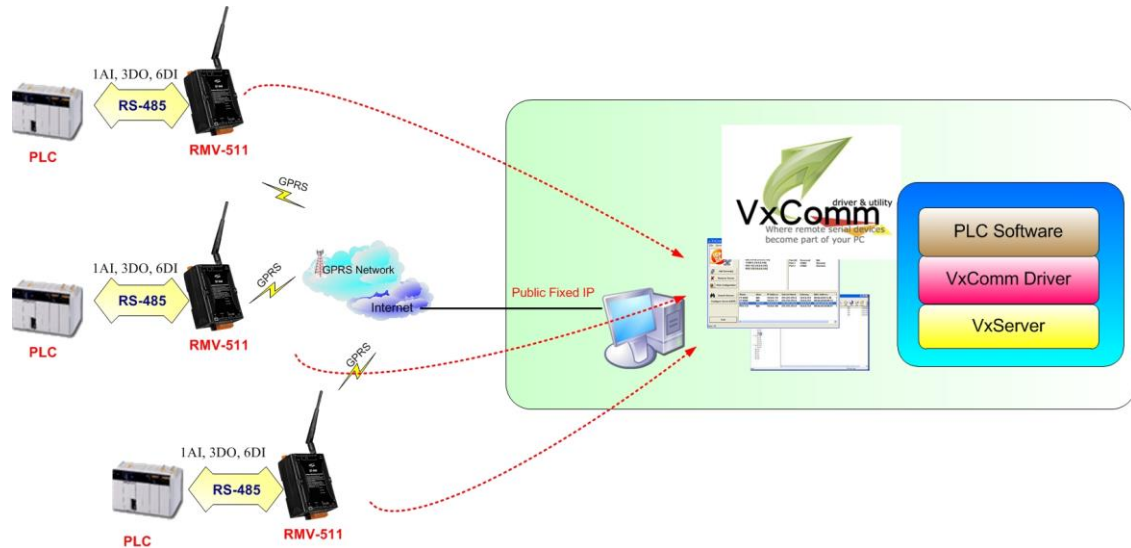

➤ Remote serial devices monitor

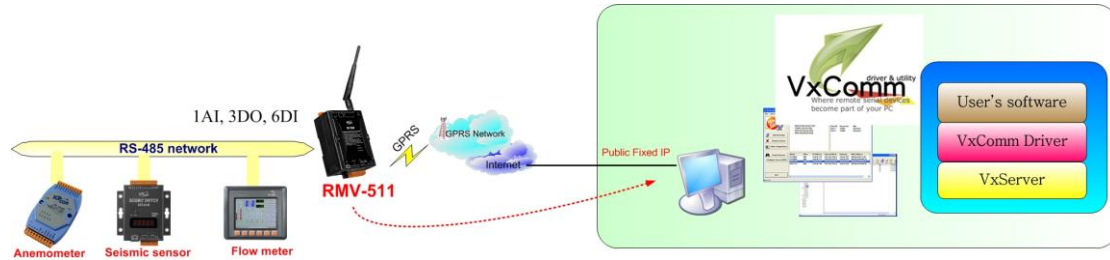

2. Hardware

2.1 Specifications

System	
CPU	32 bit CPU
SRAM	64 Kbytes
Flash Memory	512 Kbytes
RTC	Gives time(sec, min, hour) & data, leap year compensation
WDT(watchdog)	Yes
GSM/GPRS Module	
Frequency Band	Quad-band: 850/900/1800/1900 MHz
Compliant with GSM Phase 2/2+	Class 4 (2 W @ 850/900 MHz)
	Class 1 (1 W @ 1800/1900 MHz)
Coding Schemes	CS 1, CS 2, CS 3, CS 4
Download	Max download speed 85.6 kbps
Upload	Max upload speed 42.8 kbps
GPRS multi-slot	Class 10/8
Serial ports	
Utility port	RS-232: TxD, RxD, GND (use for device configuration and debug)
COM1	RS-485: D+, D- (use for communication with other devices)
Baud Rate	2400 · 4800 · 9600 · 19200 · 38400 · 57600 and 115200 bps
Digital Input	
Channels	6
Input Type	Sink or Source, Isolated channel with common power or ground
OFF Voltage Level	+1V max
ON Voltage Level	+3.5 ~ 30 V _{DC}
Isolated Voltage	3750 V _{rms}
Digital Output	
Channels	2
Output Type	Open-Collector(NPN)(100mA@30V _{DC})
Load Voltage	+30 V max
Load Current	100 mA max
Isolated Voltage	3750 V _{rms}

Analog Input	
Channels	1
Resolution	12 bits
Input Range/Type	0~20 mA
Power	
Protection	Reverse polarity protection
Frame Ground Protection	ESD, Surge, EFT, Hi-Pot
Required Supply Voltage	+10 VDC ~ +30 VDC
Mechanical	
Casing	Plastic
Flammability	UL 94V-0 materials
Dimensions (W x L x H)	91 mm x 132 mm x 52 mm
Installation	DIN-Rail
Environmental	
Operating Temperature	-25 °C ~ +75 °C
Storage Temperature	-30 °C ~ +80 °C
Ambient Relative Humidity	5 ~ 95% RH, non-condensing

2.2 Appearance and Pin Assignments

The following figure shows the appearance of RMV-511.

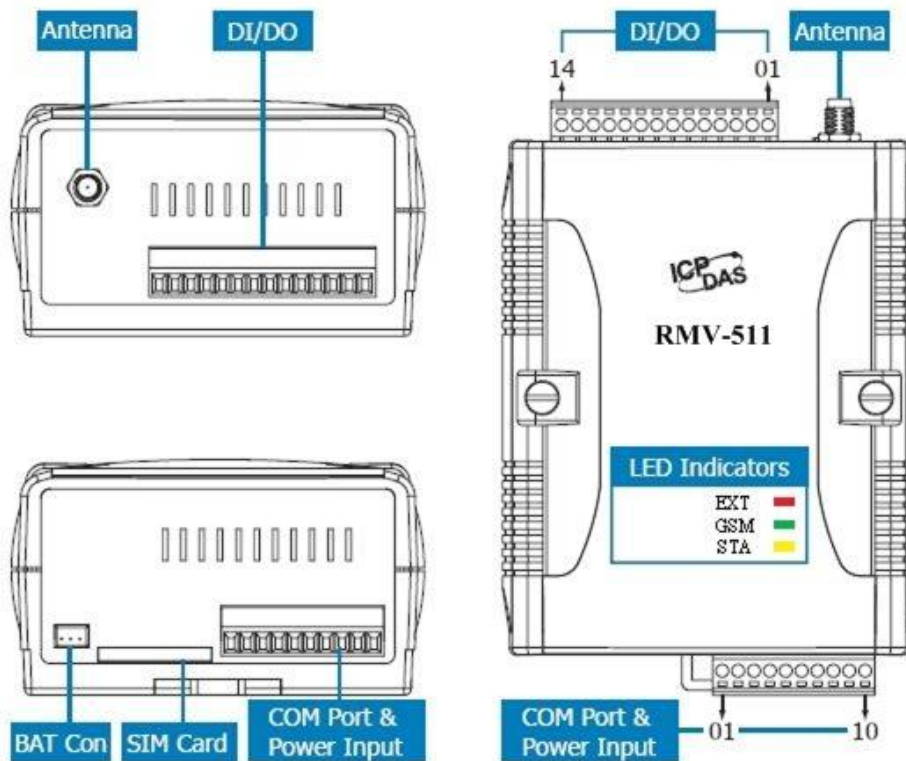

DI/DO		
Terminal No.		Pin Assignment
DI	01	DI0
	02	DI1
	03	DI2
	04	DI3
	05	DI4
	06	DI5
DI COM	07	DI COM
DO PWR	08	DO PWR
DO	09	DO0
	10	DO1
DO GND	11	DO GND
N/A	12	N/A
Ain+	13	Ain+
Ain-	14	Ain-

COM Port & Power Input		
Terminal No.		Pin Assignment
Ground for COM	01	GND
Utility Port RS-232	02	RxD1
	03	TxD1
COM1 RS-485	04	D+
	05	D-
Reset	06	RST+
	07	RST-
Power Input: +10 ~ 30 V _{DC}	08	DC.+VS
	09	DC.GND
Frame Ground	10	F.G

2.3 Dimensions

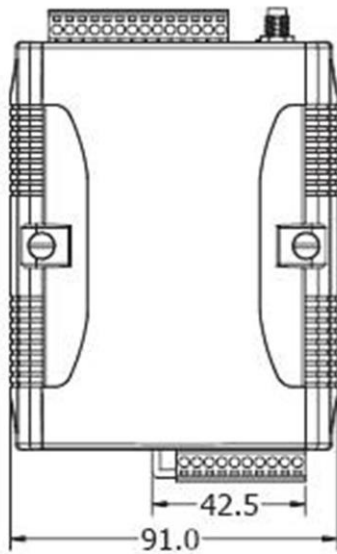

Front View

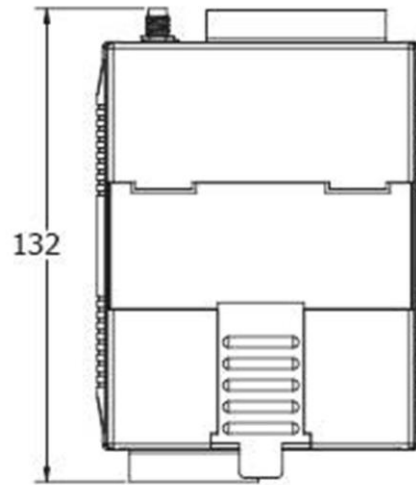

Back View

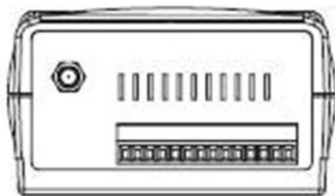

Top View

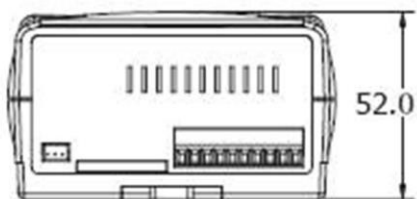

Bottom View

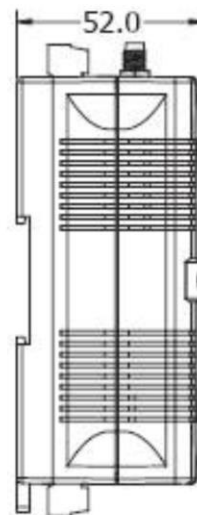

Left Side View

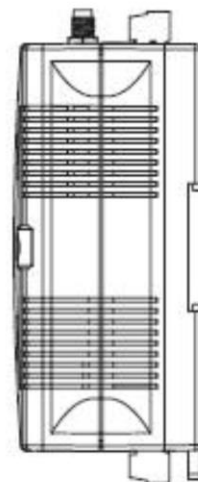

Right Side View

2.4 DI/DO internal Structure and Wire Connection

(1) DO Internal Structure

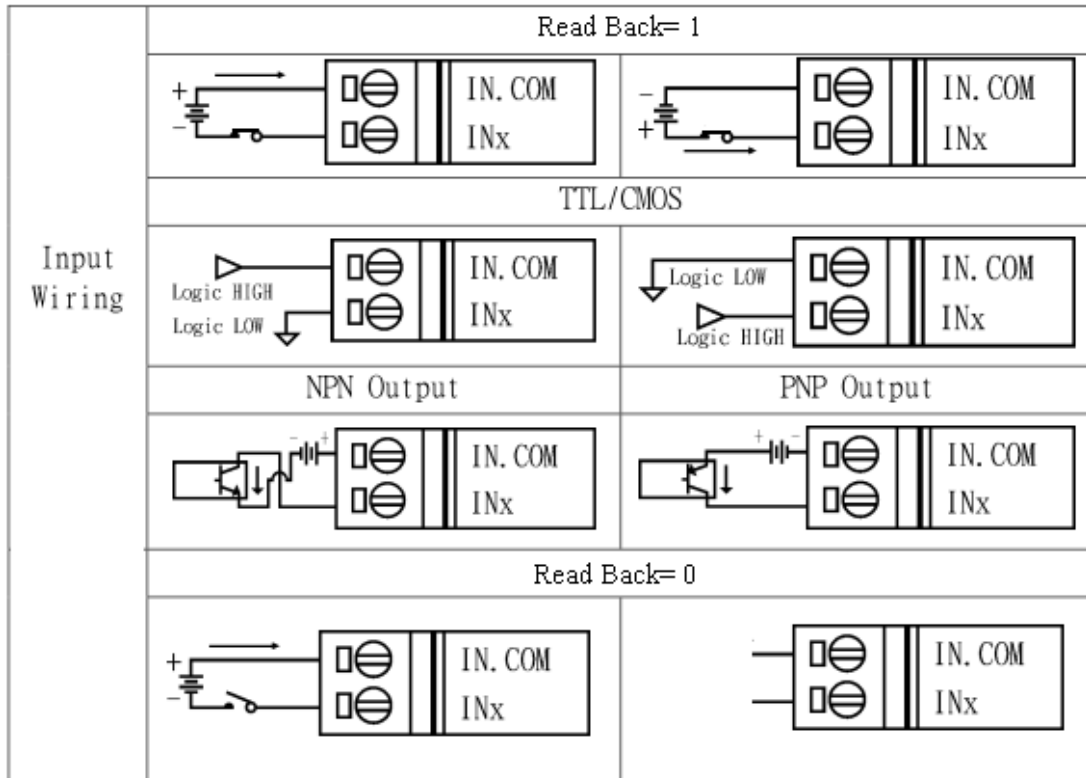

(2) DI Internal Structure

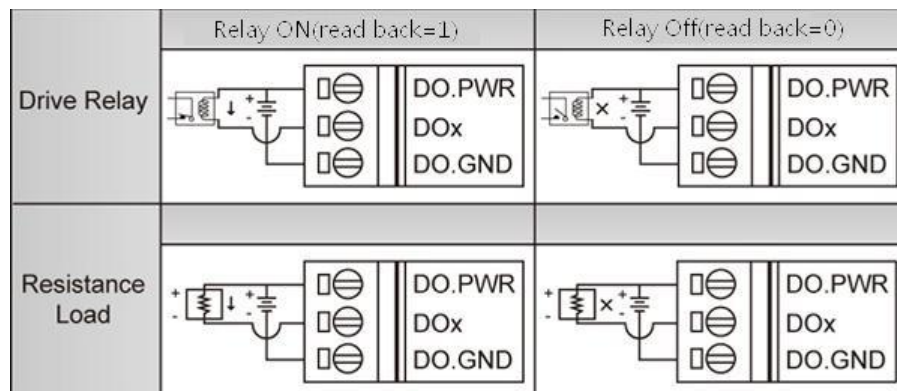

2.5 LED Indicators

There are three LED indicators to help users to judge the various conditions in the RMV-511. The description is as the following:

- (1) EXT (Red): The External Power LED indicated status whether the power is supplied or not. The description is as the following:

The Power is active	The Power is not active
ON	OFF

- (2) GSM (Green): The modem LED can indicate the status of GSM module.

GSM module normal	GSM module failed
Blinking (3 sec)	Off Or Blinking (not 3 sec)

- (3) STA (Orange): The system LED indicated whether the RMV-511 is normal of failed.

First Use	No connected to VxServer	Successful connection	Wrong PIN/PUK code
Off	Blinking(500 ms)	Blinking (1 sec)	Blinking (50 ms)

2.6 Installing RMV-511

If users want to start RMV-511 normally, it needs to follow these steps to install the RMV-511 below:

- A. Install the GSM antenna
- B. Plug in the normal SIM card (Before apply the SIM card, confirm it is OK by mobile phone.)
- C. Pin08 and Pin09 connect to the DC.+VS and DC.GND of the power supply.
- D. Follow the section 2.4 to wire the I/O connection.
- E. If you want to use the backup power, please connect the Li-battery to RMV-511.

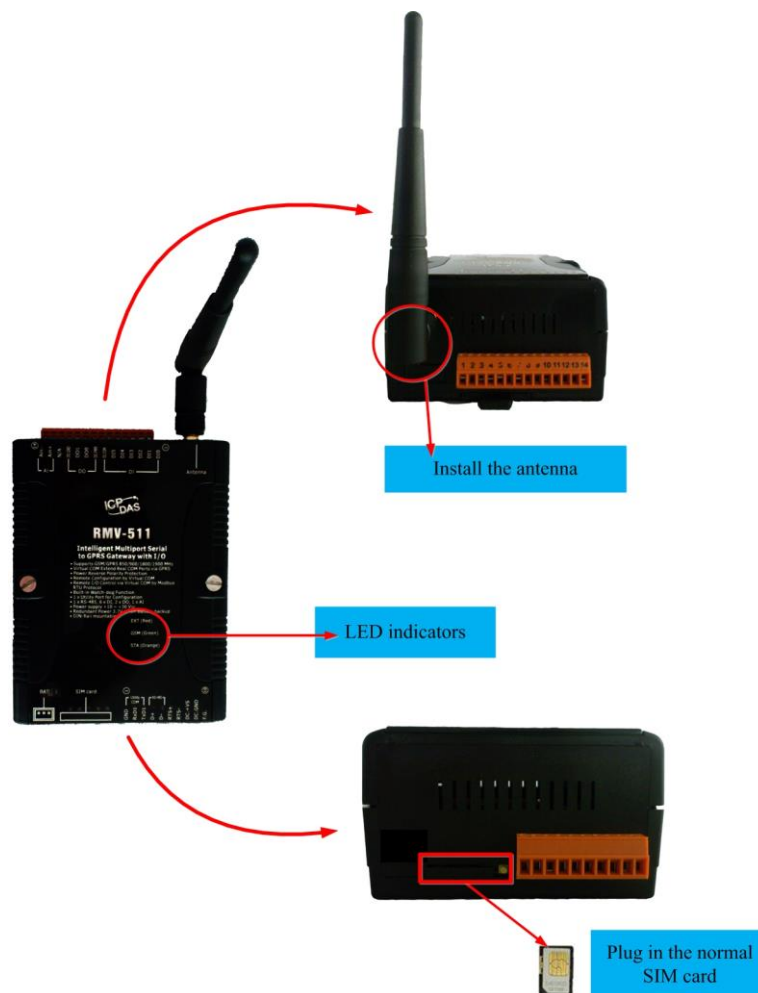

3. Installing the RMV-511 Utility

3.1 Installing .NET Framework

It needs the runtime environment with .NET Framework 2.0 or above to execute the RMV-511 Utility in the PC. If there has .NET Framework 2.0 or above in the PC, the section 3.1 can be omitted.

- Microsoft .Net Framework Version 2.0:

<http://www.microsoft.com/downloads/details.aspx?FamilyID=0856eacb-4362-4b0d-8edd-aab15c5e04f5&DisplayLang=en>

- Microsoft .Net Framework Version 3.5:

<http://www.microsoft.com/downloads/details.aspx?familyid=333325FD-AE52-4E35-B531-508D977D32A6&displaylang=en>

-
1. Press "Next" to the next step.

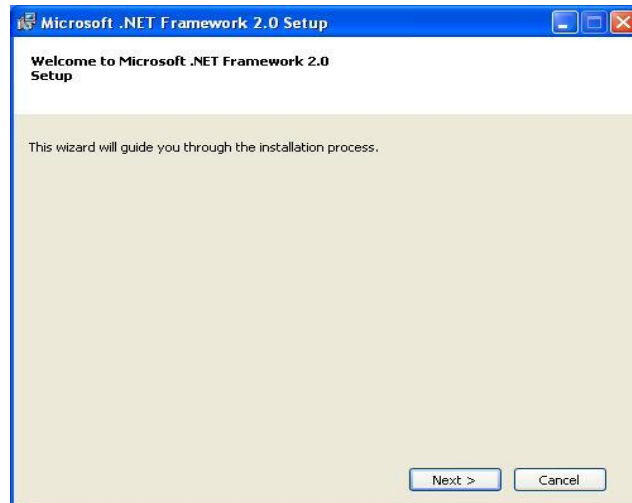

2. Select the "I accept the terms of the License Agreement" and "Install" to the next step.

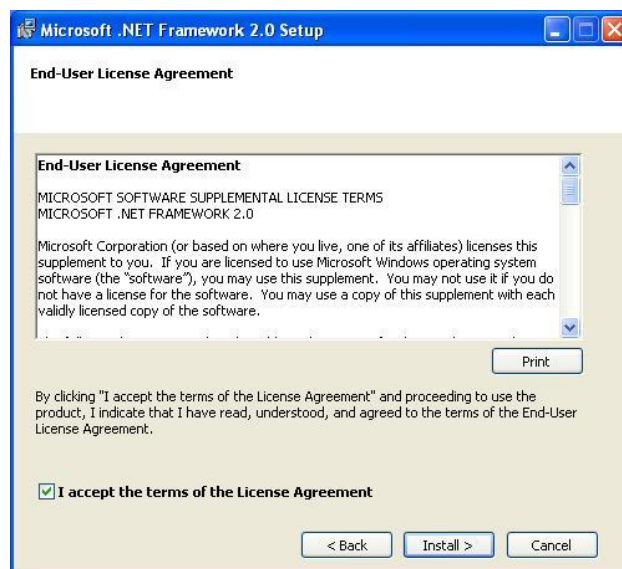

3. The installation process would be going

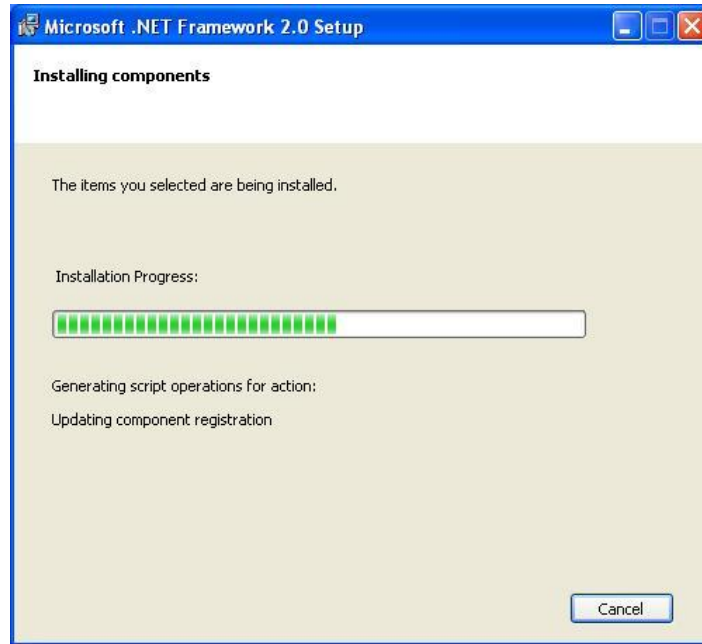

4. After finishing the installation, press "Finish" to exit the program.

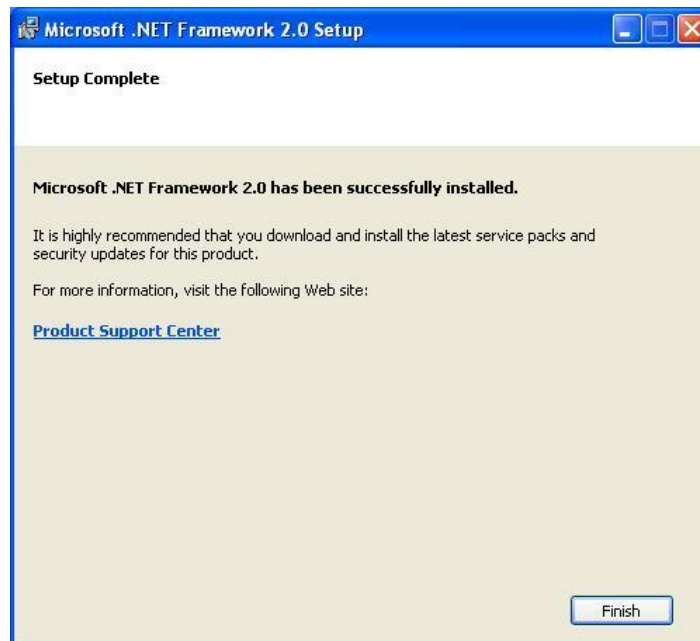

3.2 Installing the RMV-511 Utility

Plug in the shipment CD into the PC,
Execute\RMV-511\Software\RMV-511_Utility_Setup_Vx.xx.exe The installation figure is as follows:

1. Press "Next" to start the installation procedure.



2. Select the installation path. The default path is "C:\ICPDAS\RMV-511_Utility". Press "Next" to the next step.

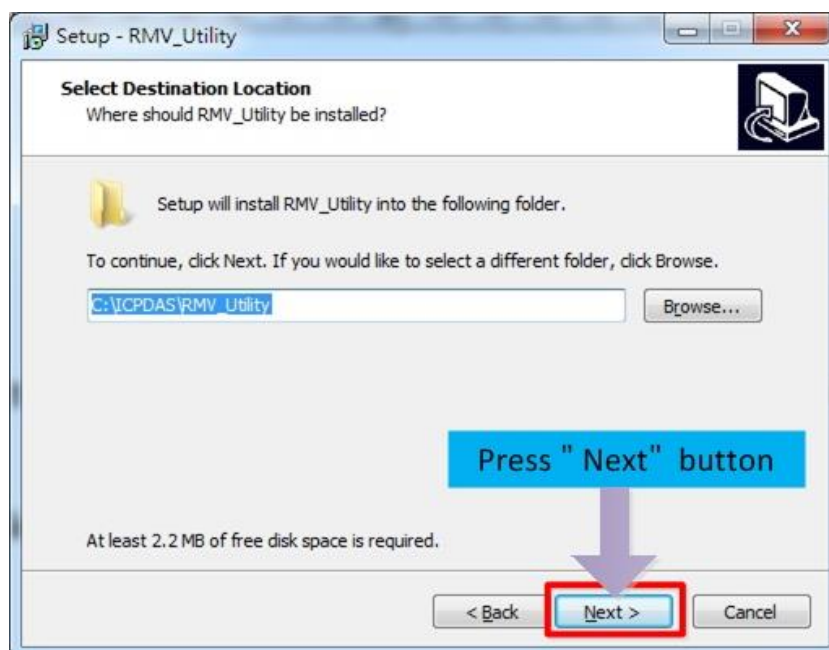

3. Select the "Start Menu Folder", Press "Next" to the next step.

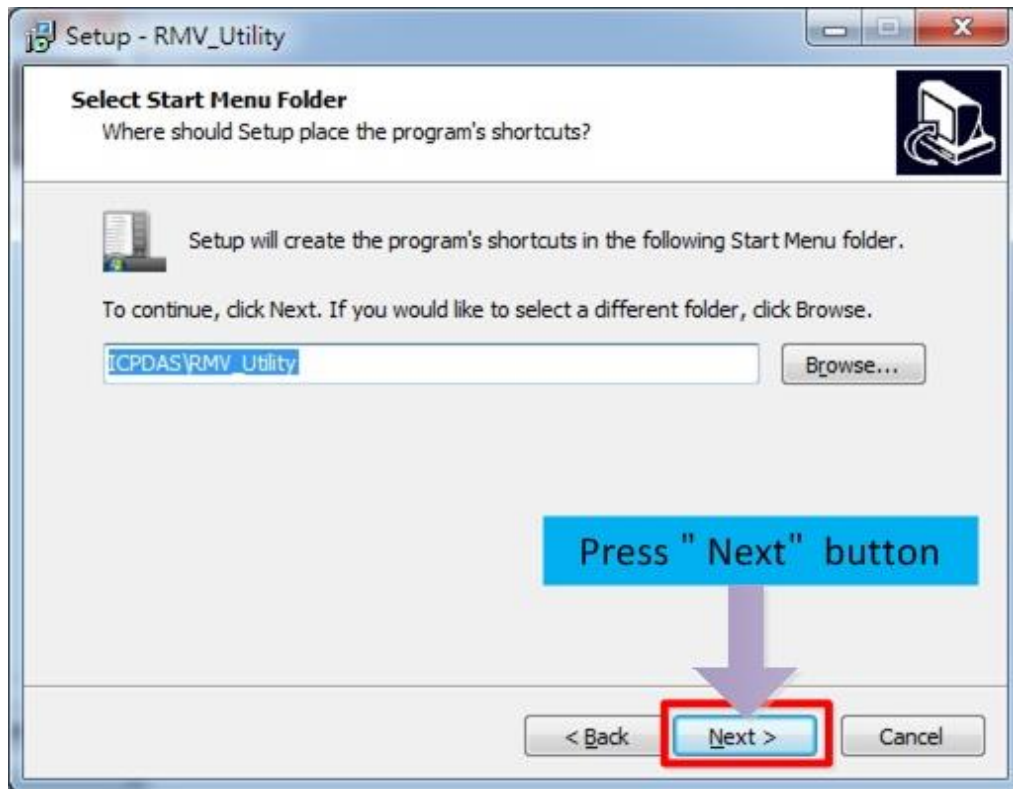

4. Select additional tasks. Press "Next" to the next step

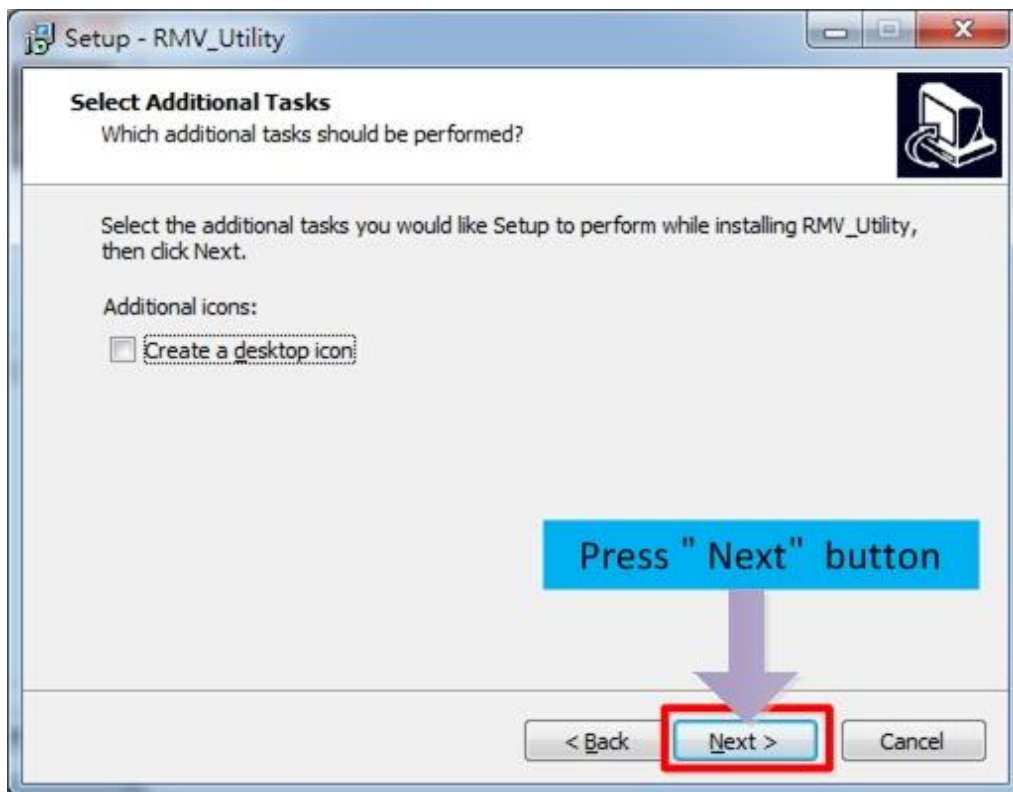

5. Click "Install" to start to install the RMV-511 Utility

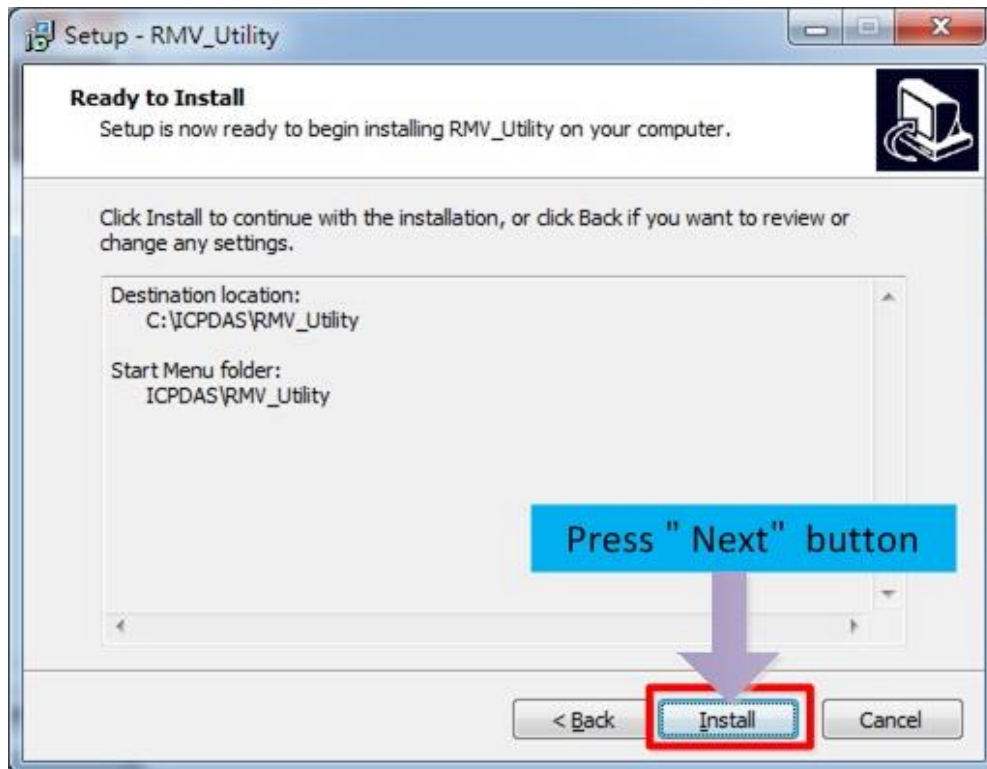

6. Click "Finish" to finish installing RMV-511 Utility



4. The RMV-511 Utility operation description

4.1 Main Menu

The main menu of RMV-511 Utility includes the following sections:

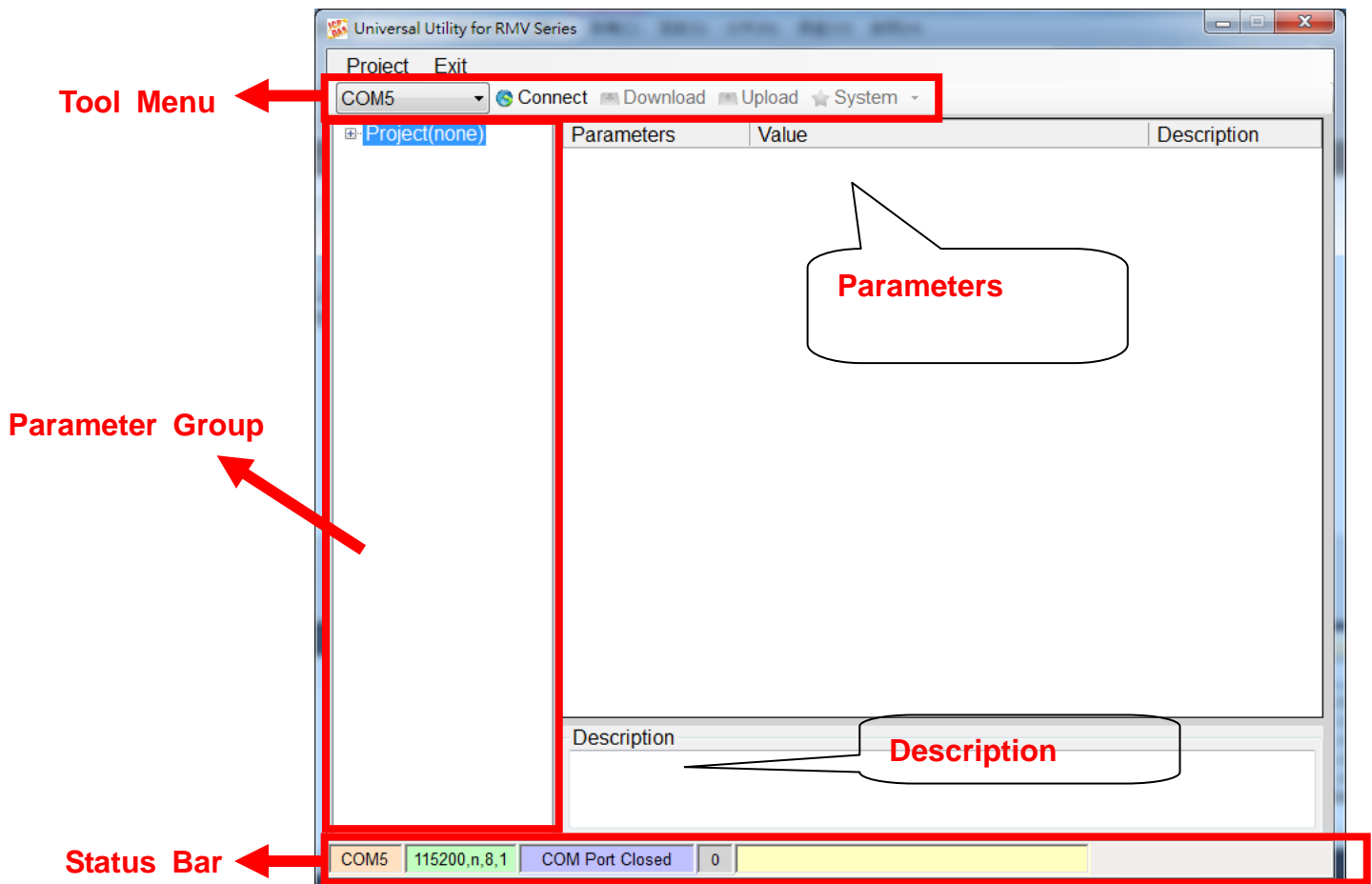

(1) Tool Menu:

These tools include all the function operation of the RMV-511 Utility. The description is as the following:

1. Project:

The parameters of the RMV-511 can be saved as the project file. The operation functions include "New", "Open", "Save", "Save as...", and etc...

2. Exit:

Exit the RMV-511 Utility

3. COM Port:

The COM Port number of the host PC connecting to the RMV-511.

4. Connect:

Connecting to the RMV-511.

5. Download:

Downloading the settings to the RMV-511 device.

6. Upload:

Uploading the settings from the RMV-511 device to RMV-511 Utility.

7. System:

Providing some system operations including "Signal Quality" 、 "Reboot RMV-511" 、 "Input PIN/PUK" 、 "Recover Default Settings" 、 "System status" 、 "Firmware Version".

(2) Parameter groups:

There are four parameter groups in the RMV-511 Utility including: "System" and "COM Port"

(3) Parameters:

Show or set the parameters.

(4) Description:

A particular or minute account

(5) Status Bar:

This bar can show the operation procedure of the RMV-511 Utility. From left to right, they are:

1. The used com port number
2. Communication configuration of the COM Port
3. The current status of the COM port
4. The address of the RMV-511
5. The result for operating the functions

4.2 File Menu

This tool provides users to operate the project file. It can save the RMV-511 configuration as the file or upload the settings from the file. It is convenient to manage a lot of RMV-511s. The explanation is as the following:

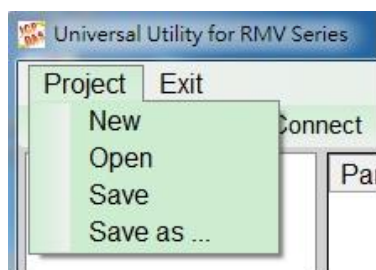

New: Opening a new file

Open: Opening a existed file

Save: Saving the file.

If the parameters are changed or save the uploading parameters from the RMV-511, you can use this function to save these configurations.

Save as: Saving the file as another name

4.3 Connecting to the RMV-511

For connecting to the RMV-511, you can follow the steps below.

- (1) Select the COM port of the host PC and connect to the Utility port of RMV-511.

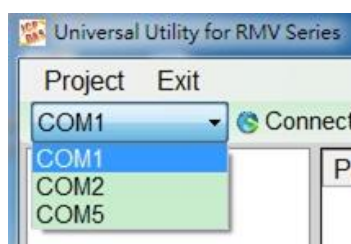

- (2) Press "Connect" to connect to the RMV-511. If the connection is failed, check the COM port settings and wiring.



4.4 Parameters

The parameters would be shown in the right of the windows if click the tree field in the left side of the RMV-511 Utility. Press the parameters' "Value" filed can change these parameters as the following figure. There are 12 items in the system field below.

Parameters	Value	Description
Protocol	VxComm Mode	Read Only
Address	1	Read Only
Remote Server	1.2.3.4	Type remote ser...
Remote Server Port	11000	Type remote ser...
Internet user name	GUEST	This parameter ...
Internet password	GUEST	This parameter ...
Internet APN	INTERNET	This parameter ...
Virtual IP	127.0.11.99	Range: 127.0.0....
Module Alias	ICPDAS	Module's alias, ...
Heartbeat Time	10	Heartbeat Time ...
Com End Method	0	This parameter ...
Com End Param.	2	This parameter ...

COM5 115200,n,8,1 COM Port Connected 1 Read all parameters successfully!!

Parameters	Description
Protocol	RMV-511 support protocol. Read only
Address	The address of the RMV-511. Read only
Remote Server	The remote VxServer server's IP or domain name
Remote Server Port	The remote VxServer server's Port
GPRS User name	GPRS user name
GPRS password	GPRS password
GPRS APN	GPRS APN (access point name)
Virtual IP	Virtual IP. Range: 127.0.0.1~127.255.255.254 · This parameter can't be the same with other device.
Module Alias	Module Alias. (max. 7 character)

Heartbeat Time	Heartbeat time. Range: 10 sec. ~ 65535 sec.		
Com End Method	Com End Method	Com End Param.	Remark
	0: Fixed Time. It is as complete a data when no data came at a fixed time	2 ms~ 65535 ms	The RMV-511 will transmit a data when there is a data more than 1000 bytes.
Com End Param.	1: Fixed Length , It is as complete a data when the length of a data more than fixed length	1 ~ 1000	
	2: Fixed end byte. It is as complete a data when receives the fixed end byte. Like "CR" (0x0d)	0 ~ 255	

4.5 Download/Upload Parameters

(1) Download parameters

As the configuration is finishing, the function can download the parameters to the RMV-511 by clicking "Download" as the following figure.



(2) Upload Parameters

"Uploading" button can upload the parameters from the RMV-511 as the following figure.

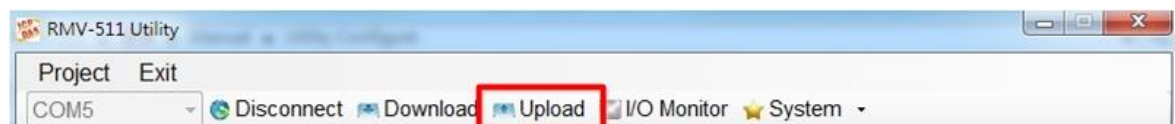

4.6 I/O Monitor

(1) Press "I/O monitor" can show the I/O status.

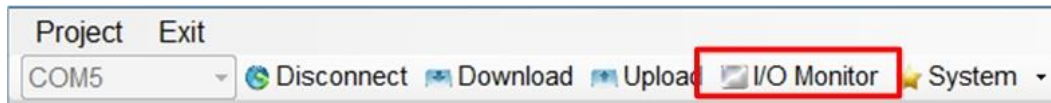

(2) This function is used to control DO0 and DO1 channels and show the status of DI channels and AI value. It will automation get the IO status per 5 sec.

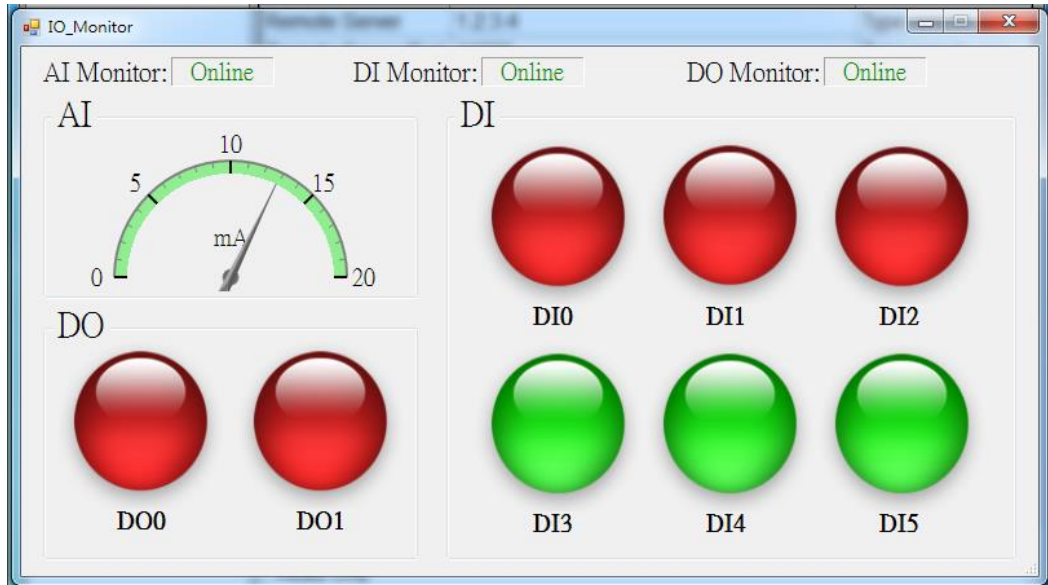

Text field:

A. AI/DI/DO Monitor :

- Online : Get I/O status succeed.
- Offline : Get I/O status failed.

B. DI0 ~ DI5 、 DO0 ~ DO1 :

- Green : The voltage logic is high
- Red : The voltage logic is low

C. AI : The AI current value

(3) If you want to set the DO output ON/OFF, click the DO0/1 picture

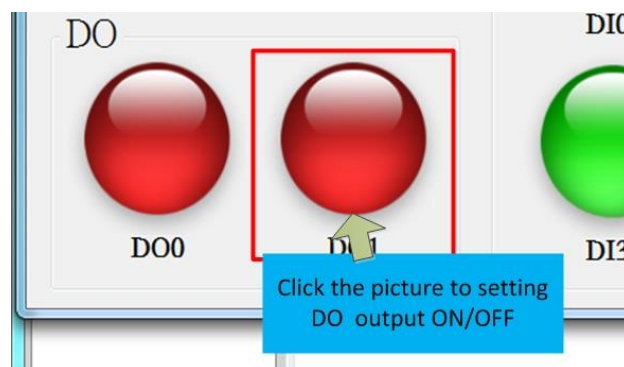

4.7 System

4.7.1 Signal Quality

Click "System->Signal Quality" can show the signal quality windows to know the GSM signal strength.

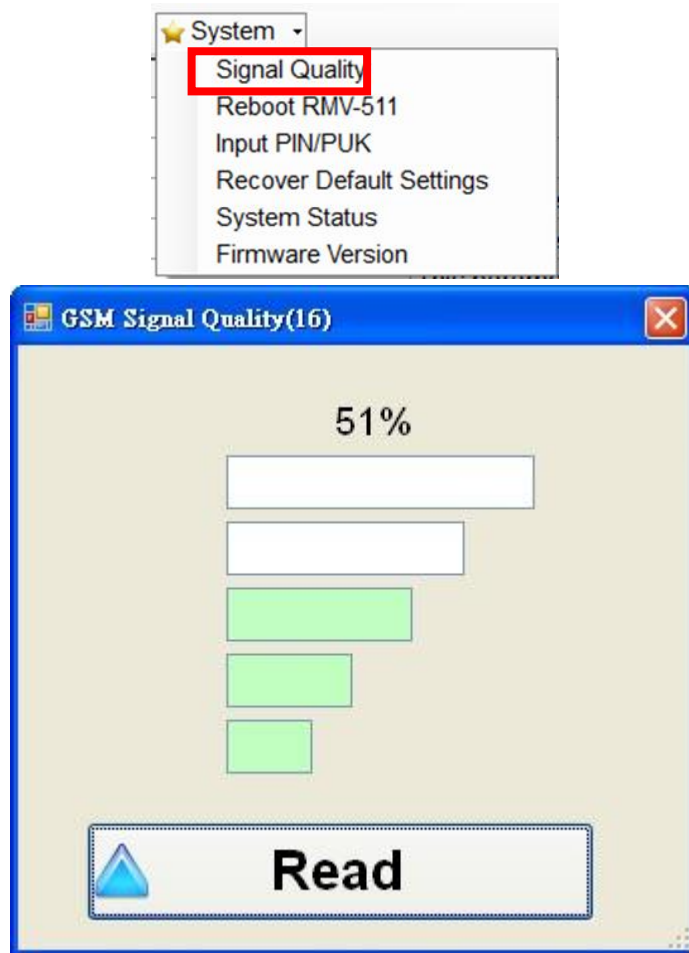

Field Description:

The strength is divided into 5 sections shown in percentage.

Operation:

Read : Read the GSM signal strength from the RMV-511.

4.7.2 Reboot the RMV-511

Clicking "System->Reboot RMV-511" button can reset the RMV-511 as follows.

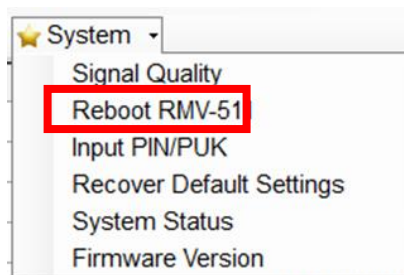

4.7.3 Inputting the PIN/PUK

When the RMV-511 starts and the STA LED is blanking per 50 ms, it is needed to input the PIN or PUK code in the RMV-511. In this condition, click "System->Input PIN/PUK" button to set the PIN/PUK code.

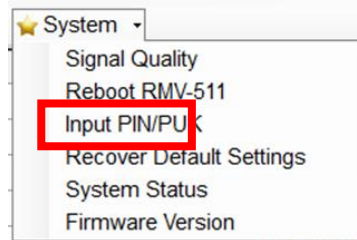

(1) Asking for inputting PIN code:

If the PIN code is effective, the "Enter SIM PIN/SIM PUK" window would pop-up as follows. If the number of times for inputting the wrong PIN code is more than the allowed number, the PIN code would be ineffective. And the "PUK code" window would pop up.

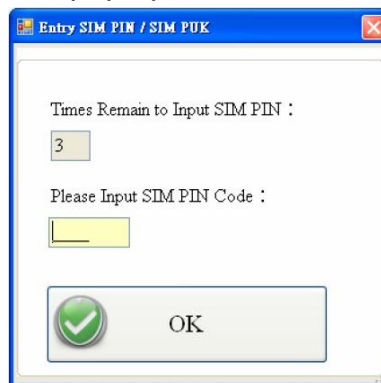

(2) Asking for inputting PUK code:

If the PIN code is ineffective, the "PUK code" window would pop-up as follows. As the number of times for inputting the wrong PUK code is more than allowed number, the SIM card would be ineffective forever. Therefore, it is important to input the correct PUK code.

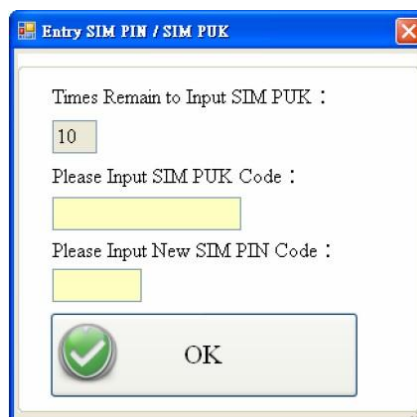

4.7.4 Recover to the Factory Settings

It can recover the RMV-511 to the default settings by clicking "System->Recover Default Settings".

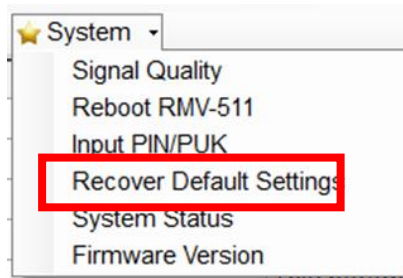

4.7.5 Inquiring System status

Press "System→System status" in tool menu, and the window would show the RMV-511 working status

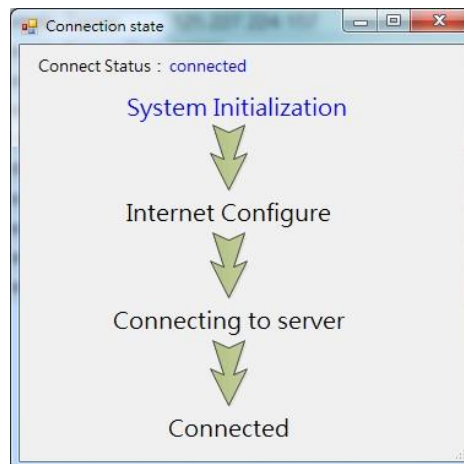
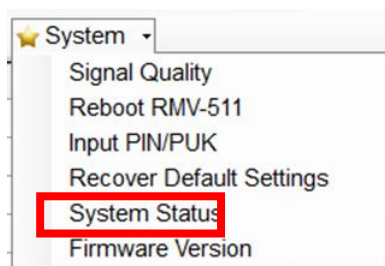

Field instruction:

- Connect Status:
 - Connected: Get RMV-511 status is succeed.
 - Disconnected: Get RMV-511 status is failed.
- Text color:
 - Blue: The step is finish.
 - Black: The step is unfinished.

4.7.6 Inquiring Firmware Version

Press "System->Firmware Version" in tool menu, and the window would show the versions of the RMV-511 Utility and firmware.

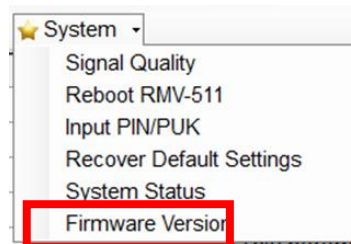

5. How to use the RMV-511 Utility through the Virtual com to access remote the parameters of the RMV-511

5.1 The necessary software installed

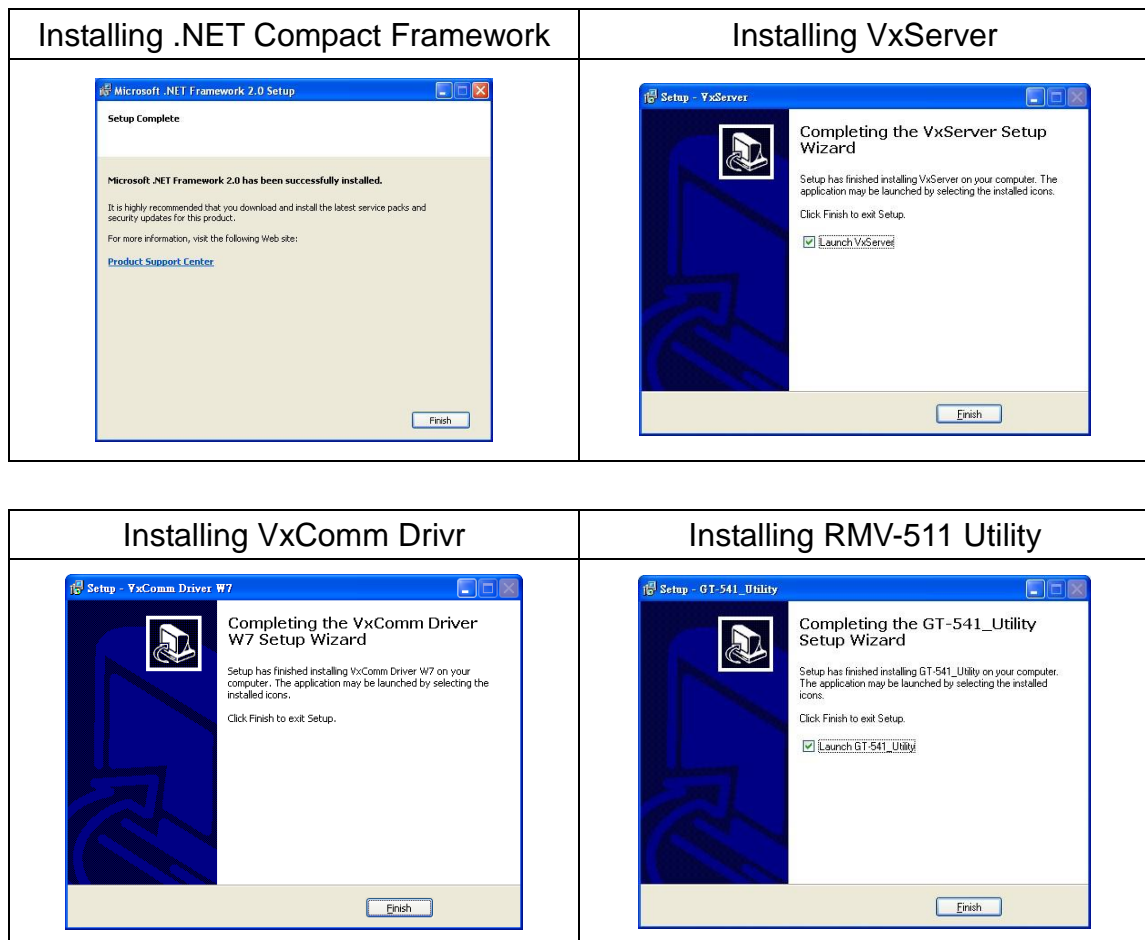

- Download Microsoft .Net Framework Version 2.0:
<http://www.microsoft.com/downloads/details.aspx?FamilyID=0856eacb-4362-4b0d-8edd-aab15c5e04f5&DisplayLang=en>
- Download VxServer software: <http://m2m.icpdas.com/VxServer.html>
- Download VxComm Driver software:
http://ftp.icpdas.com/pub/cd/8000cd/napdos/driver/vxcomm_driver/2k/
- Download RMV-511 Utility software:
<http://ftp.icpdas.com/pub/cd/usbcd/napdos/RMV-511/software/>

5.2 Setting the VxServer and VxComm Driver

- (1) Verify that the device has been connected up

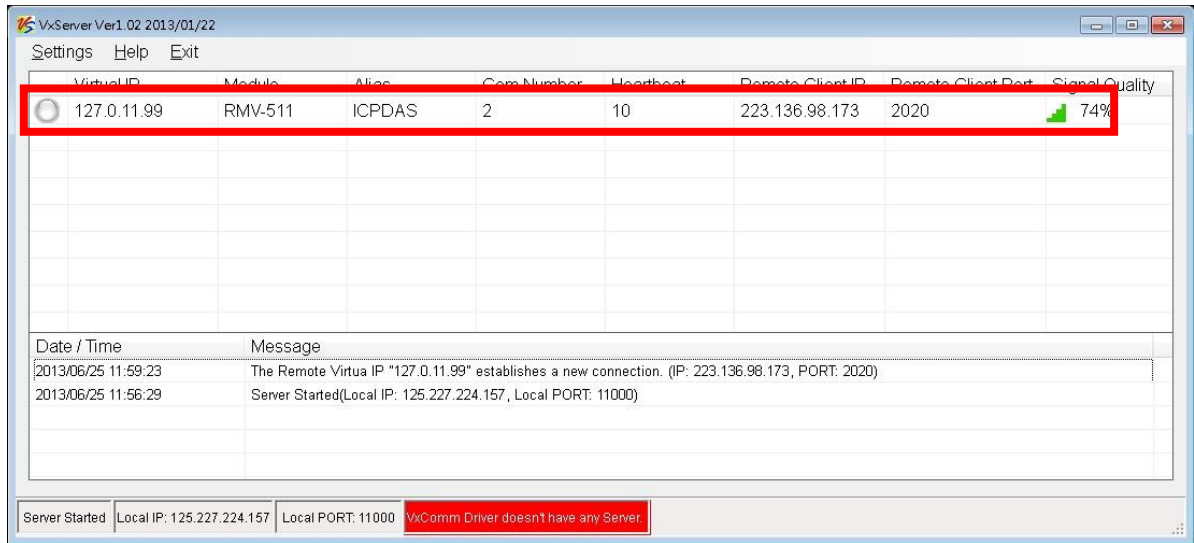

- (2) Execute VxComm Utility, then click "Search Servers"

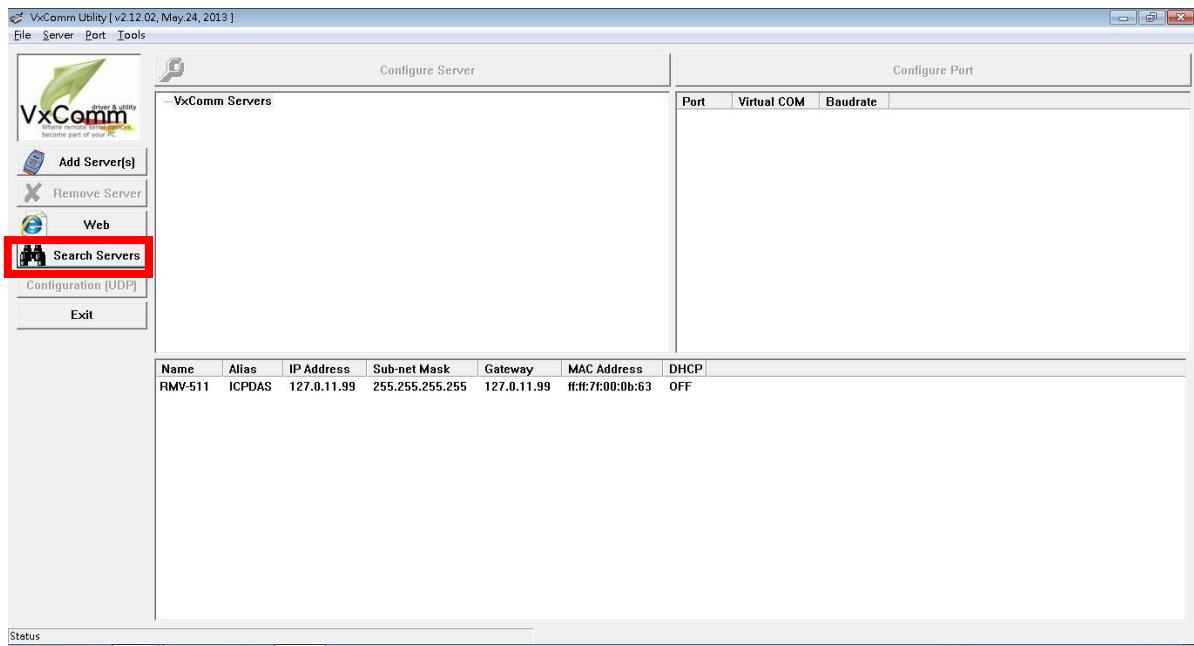

(3) Select your device, then click "Add Server(s)"

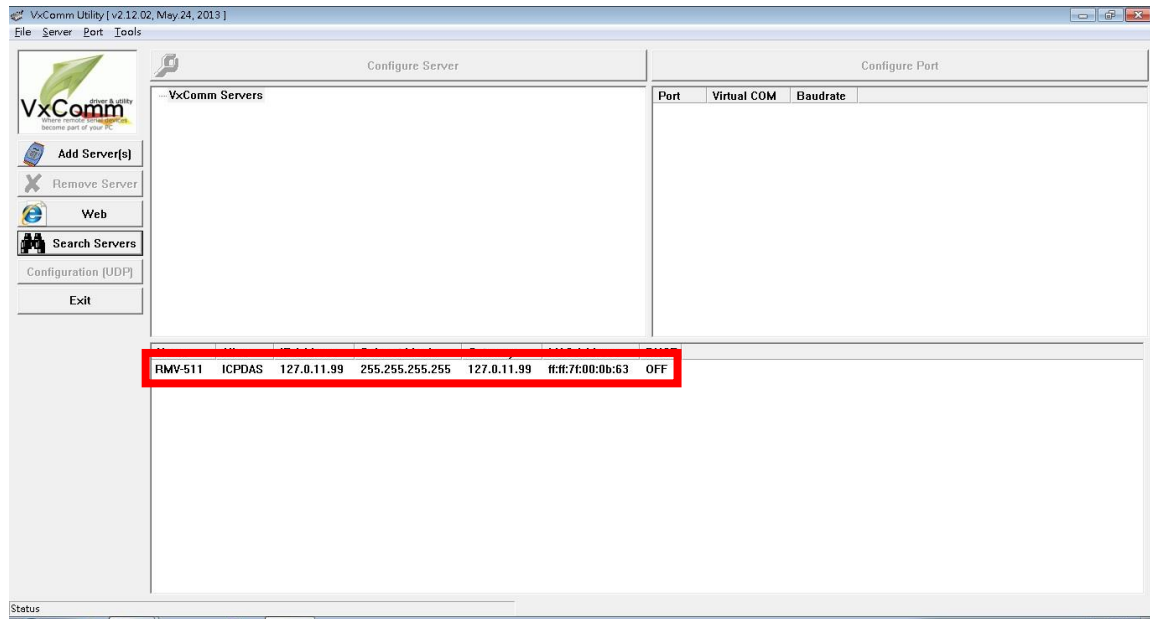

(4) IP Range=> check "Maps virtual COM ports to "Port I/O" on servers".

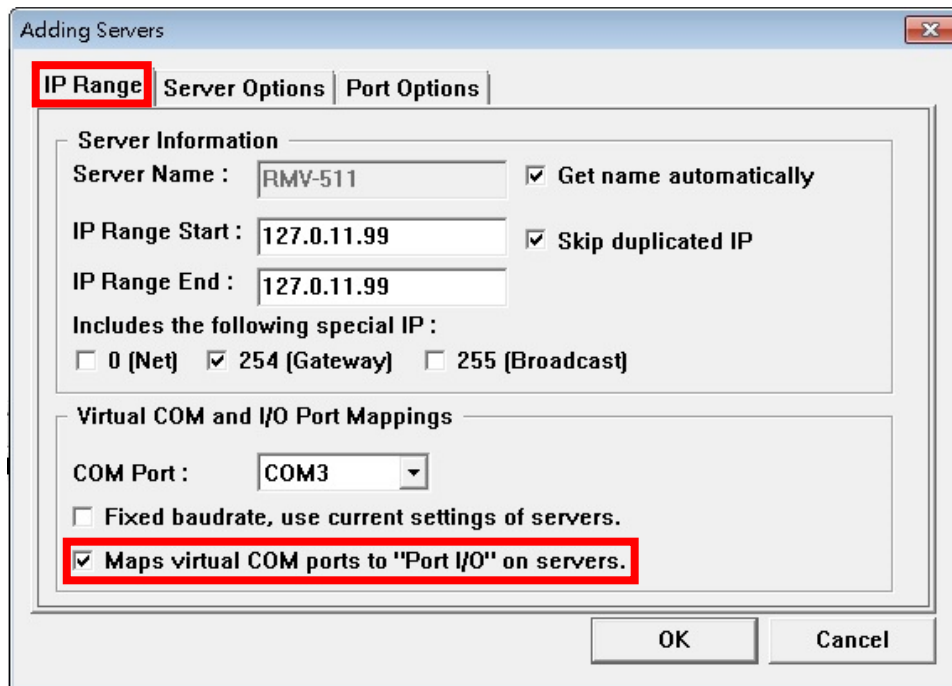

(5) Advanced Options, please follow the below parameter settings

Parameters	Fixed value
Keep Alive Time	1
Connection Broken	3
Connect Timeout	1
Command Port	10000
Virtual I/O Port	9999

The following items are all PC side settings, not device settings.

Keep Alive Time (Seconds) : 1

Connection Broken (Seconds) : 3

Connect Timeout (Seconds) : 1

Command Port (TCP): 10000

Virtual I/O Port (TCP): 9999

OK Cancel

(6) Tools => Restart Driver

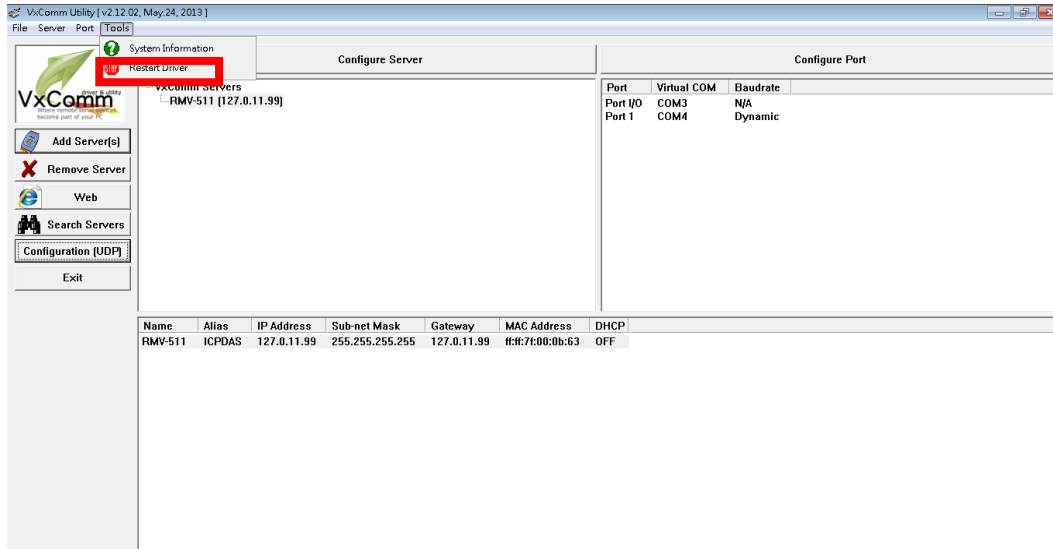

(7) Click "Restart Driver"

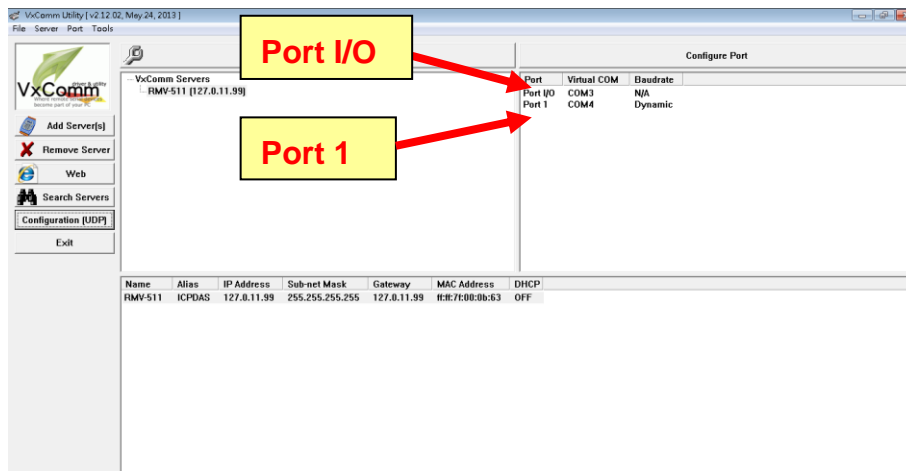

- I. Port I/O : The port I/O can configure the system parameter via RMV-511 utility, it can also get the I/O status and control the DO. I/O control methods please refer the chapter 6.
- II. Port 1 : The Port 1 mapping to the COM1 of RMV-511

- (8) According the Port I / O of VxComm Utility to select the com port of RMV-511 Utility, then click "RMV-511 Utility => Connect"

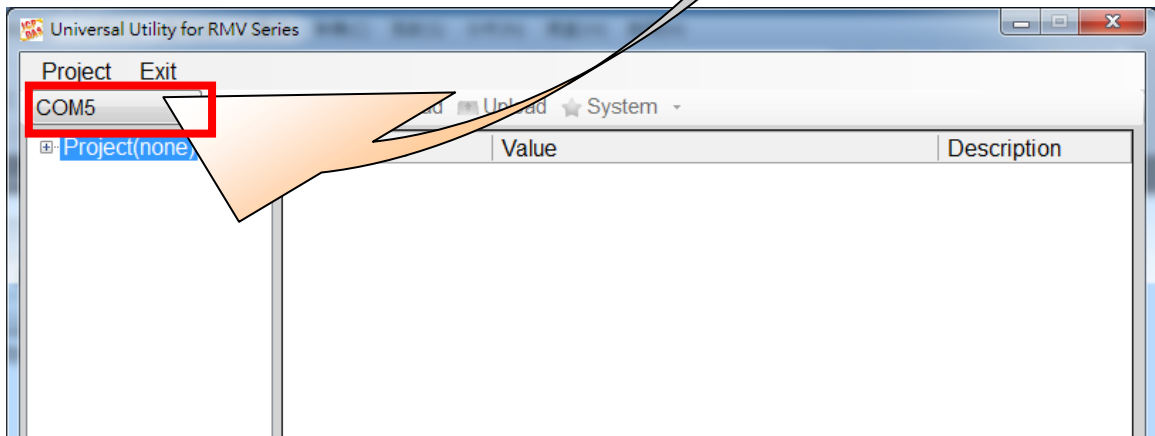
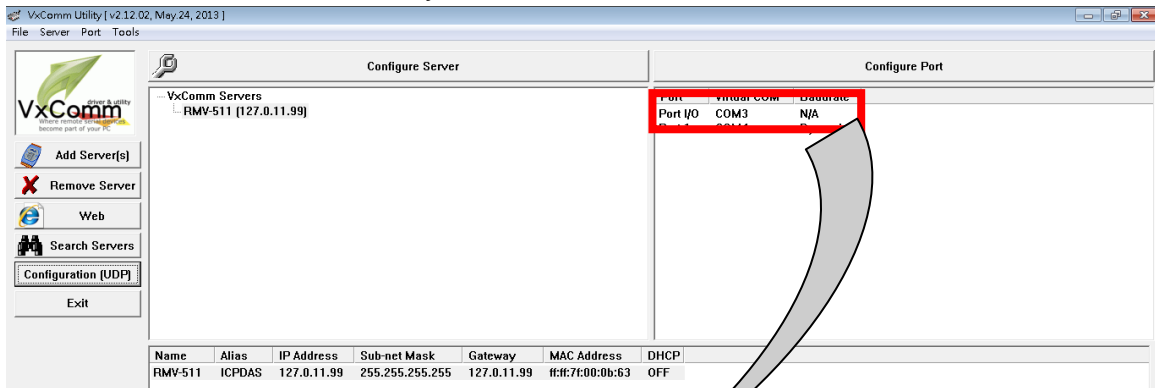

- (9) The remaining steps, please refer to Chapter 4

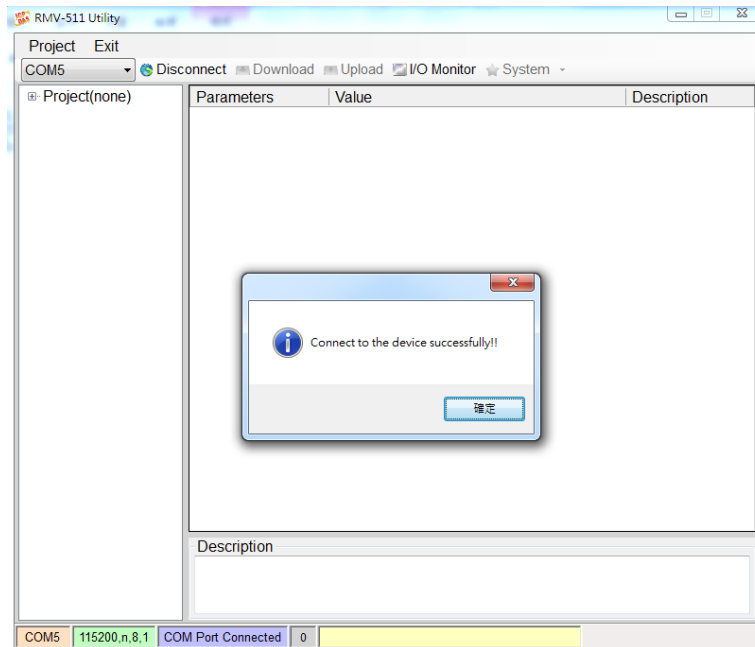

6. Modbus RTU Protocol

The RMV-511 supports the Modbus RTU protocol. The communication Baud Rates range from 2400bps to 115200 bps. The number of data bits is fixed to 8, the parity and stop bits are fixed as no parity and 1 stop bit.

The Modbus function codes supported in the RMV-511 are 1,2,4,5 and 15. The Modbus address distribution is as the following table, its Net ID is 1.

6.1 Commands and Description

(1) Read Digital Output(DO) status (Function code:1)

➤ Request

00	Net ID	1 Byte
01	Function code	1 Byte
02 ~ 03	Starting address	2 Byte
04 ~ 05	DO count	2 Byte

➤ Response

00	Net ID	1 Byte
01	Function code	1 Byte
02	Byte count of response ($B=(DO\ count+7)/8$)	1 Byte
03 ~ (B+2)	Bit value	3-(B+2) Byte

(2) Read Digital Input status (Function code:2)

➤ Request

00	Net ID	1 Byte
01	Function code	1 Byte
02 ~ 03	Starting address	2 Byte
04 ~ 05	DO count	2 Byte

➤ Response

00	Net ID	1 Byte
01	Function code	1 Byte
02	Byte count of response ($B=(DO\ count+7)/8$)	1 Byte
03 ~ (B+2)	Bit value	3-(B+2) Byte

(3) Read Analog Input value (Function code:4)

➤ Request

00	Net ID	1 Byte
01	Function code	1 Byte
02 ~ 03	Starting address	2 Byte

04 ~ 05	AI count	2 Byte
---------	----------	--------

➤ Response

00	Net ID	1 Byte
01	Function code	1 Byte
02	Byte count of response (B=2*AI count)	1 Byte
03 ~ (B+2)	AI value	3-(B+2) Byte

(4) Set Digital Output (Function code:5)

➤ Request

00	Net ID	1 Byte
01	Function code	1 Byte
02 ~ 03	Starting address	2 Byte
04	= FF: High, = 00: Low	1 Byte
05	= 00	1 Byte

➤ Response

00	Net ID	1 Byte
01	Function code	1 Byte
02 ~ 03	Starting address	2 Byte
04	= FF: High, = 00: Low	1 Byte
05	= 00	1 Byte

(5) Set multi Digital Output (Function code:15)

➤ Request

00	Net ID	1 Byte
01	Function code	1 Byte
02 ~ 03	Starting address	2 Byte
04 ~ 05	Bit count	2 Byte
06	Byte count $B=(\text{bit count}+7)/8$	1 Byte
07 ~ (B+6)	Data to be written	1 Byte

➤ Response

00	Net ID	1 Byte
01	Function code	1 Byte
02 ~ 03	Starting address	2 Byte
04 ~ 05	Bit count	2 Byte

6.2 Modbus address table

(1) DO status (Function Code:1,5,15)

Address(Dec)	Address(Hex)	Description	Attribute
00129	0x81	If function code = 1 Read DO0	R/W
		If function code = 5,15 Set DO0, 1:High, 0:Low	
00130	0x82	If function code = 1 Read DO1	R/W
		If function code = 5,15 Set DO1, 1:High, 0:Low	

(2) DI status (Function Code:2)

Address	Data Address	Description	Attribute
00000	0x00	Read DI0	R
00001	0x01	Read DI1	R
00002	0x02	Read DI2	R
00003	0x03	Read DI3	R
00004	0x04	Read DI4	R
00005	0x05	Read DI5	R

(3) AI status(Function Code:4)

Address	Data Address	Description	Attribute
30027	0x1B	Read AI value (hex)	R
30028	0x1C	Read AI value (engineering)	R

Note:

1. AI value(Hex) conversion formulas: $AI = (AI \text{ Hex} * 20) / FFF$
2. AI value(engineering) conversion formulas: $AI = AI(\text{engineering})/1000$

Example:

(1) If read AI value(Hex) is "FF"

$$AI = (FF * 20) / FFF = (255*20)/4095 = 1.25 \text{ mA}$$

(2) If read AI value(engineering) is "1250"

$$AI = 1250/1000 = 1.25\text{mA}$$